



**ANGUS SINCLAIR**

# DEVELOPMENT OF THE LOCOMOTIVE ENGINE

A history of the growth of the locomotive from its most elementary form, showing the gradual steps made toward the developed engine, with biographical sketches of the eminent engineers and inventors who nursed it on its way to the perfected form of to-day. Many particulars are also given concerning railroad development

By **ANGUS SINCLAIR**

Member of American Railway Master Mechanics' Association, of the American Society of Mechanical Engineers, and of the Brotherhood of Locomotive Engineers, etc.



ANGUS SINCLAIR PUBLISHING COMPANY  
NEW YORK

1907

Digitized by Google

**DEDICATED,**  
With Profound Respect,  
to  
**GEORGE WESTINGHOUSE,**  
The Guardian of Railway Men  
and  
The Preserver of the Travelling Public,  
Whose great invention of the  
**AUTOMATIC AIR BRAKE**  
has preserved more human lives than any  
military general or tyrant ever  
succeeded in destroying.

“Peace hath her victories  
No less renown’d than war.”

—*Milton*

## Preface

My purpose in writing this book was based on the belief that all intelligent railway men and hosts of others are sufficiently interested in the locomotive to desire a book giving a comprehensive history of the growth of this form of engine. The first moving cause for the determination to write this book originated about thirty years ago when I read an article in a popular magazine professing to give a condensed history of the locomotive engine that was full of misstatements and errors. I wrote to the editor, pointing out some of the most glaring mistakes, such as one stating that the first portion of the New York Central Railroad was opened with an engine called the "John Bull," which had an upright boiler. The editor replied that the article was written by a person who was an authority on such matters, and that there was no doubt that the statements made were correct. On reading the editor's letter I determined to write a history of the locomotive, and I have been collecting material for it ever since.

Most of the articles composing the book have been published in the pages of *Railway and Locomotive Engineering*, my own journal. As the articles appeared I invited readers to send in corrections if they found any mistakes. They responded very exhaustively, and many of the statements have led to long discussions and correspondence. I have been actuated by an earnest desire to publish exact facts, and after sifting conflicting statements have used my best judgment to give those that are founded on the most reliable authority. That has caused the material in the book to be practically rewritten.

I give this book of history to the world with the humble hope that it may prove as free from mistakes as the most carefully written historical books have been, and that it may be found of interest to many who are engaged in railroad operations, or who may be interested in the appliances which have been used so successfully in the development of this great country. Whatever may be the popular estimate of the work, however, nothing can ever deprive me of the pleasant recollection of the many cheering words of encouragement and help connected with its preparation that have come from almost every part of the world.

# Origin and Growth of the Steam Engine

---

## CHAPTER I.

---

### **The Steam Engine the Greatest Invention.**

The history of the steam engine is a materialistic romance that has had no parallel in the records of human achievements since the world began. We can conceive of no intelligent person who would fail to read with pleasure the story of the men whose stupendous labors brought into practical form the most potent forces of nature that have ever been subdued for the use and comfort of the human race. The reflective man must view with admiration the persistent work of philosophers and mechanics who found steam as a mysterious uncontrollable agency, and reduced it to ordinary comprehension and utilitarian control.

The steam engine represents the most successful invention ever brought into use for converting the potential energy of coal or other fuels into mechanical work. It is not the most economical prime motor in use; but it possesses practical advantages over all other forms of heat engines that are likely to protract its existence for a long time to come.

### **Development Over Expensive Mistakes.**

The development of the steam engine has been a matter of slow growth, built up to a great extent on the ruins of expensive mistakes. What is now considered civilization was no doubt in its infancy when people began to find out that holding down the lid of a boiling caldron was liable to end in disaster to the cooking utensil. When accidents to the principal cooking vessel of the household first began to be noticed, through the laudable efforts of the thrifty housewife to hold in the savory fumes, diabolical agencies were supposed to have caused the explosion. Diabolic agencies were long a convenient means of explaining things that were not easily understood, and some people still cling to that way of mystifying.

others about the action of forces their limited intellect cannot comprehend.

In the world there are always some men who see farther into so-called mysteries than their neighbors. It is a long time since philosophers—searchers after truth—began to assert that the vapor from boiling water, which played havoc with the kailpot, was a natural force whose power might at some time be utilized for useful purposes. Thus speculation about steam began. Its roots were for centuries no farther spreading than those from a grain of mustard seed, but they were alive and strong with potentialities.

### Steam Engine in Egypt.

There is no means of knowing how long ago people began trying to use, in different ways, the force obtained from the ex-

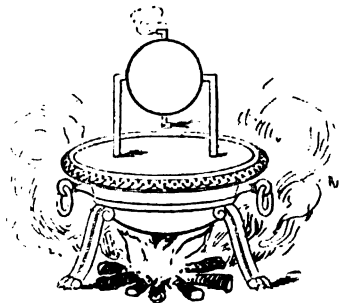

Fig. 1. Æolipile

pansion of steam; but it is certain that a crude form of steam engine was exhibited as a curiosity in Alexandria, in Egypt, two hundred years before our era began, and was described as were many other mechanical appliances in a work on pneumatics written by Hero of Alexandria about 150 B. C. There is good reason for believing that the philosophers of those days had made some progress in using the pressure of steam for mechanical purposes. The leaders of the intellectual world in ancient times were, however, much more given to theorizing about discoveries than to applying them to the service of their fellow-men. In fact, many of them would have considered it degrading to have used their inventions or discoveries to lighten the burdens carried by mankind.

The ancient Romans appear to have been familiar with the principal elements that are used in a steam engine, but

they never devised the combinations necessary to chain them into a working machine. And the spirit of utility was not sufficiently active to induce them to labor on solving the problem. Later on evil times fell upon the world, and the use of the sword almost annihilated the use of the pen. During that long period of mental darkness all sorts of inventive tendencies were discouraged unless their purpose was improving weapons for the destruction of human life.

### Whirling *Æolipile*.

The Greek conception of a steam engine is illustrated in Fig. 1 and was called a whirling *æolipile*. Mounted above a closed boiler is a hollow sphere from which two short tubes proceed in the line of its axis, and whose ends are bent in opposite directions. The sphere is suspended between two columns, their upper ends being pointed and bent toward each other, forming trunnions, one of them being hollow through which the steam passes from the boiler into the sphere as air is passed into a Bessemer converter. The steam passing out of the bent tubes by its reaction imparts a revolving motion to the sphere.

Engines of this character appear to have been employed, to some extent, for mechanical operations and industrial purposes; but their capacity was very limited. Still the *æolipile*, although little more than a mechanical toy, must have been an object of amusement and some utility to many people throughout the long dark ages, for Lord Bacon, the famous philosopher who was born in 1561, was familiar with the apparatus and proposed making improvements upon it which seem never to have been carried out. It was used in castles and monasteries for turning the spit on which meat was roasted.

### Branca's Crude Steam Turbine.

A book published in Rome in 1629 describes and illustrates a steam engine invented by Giovanni Branca, which had elements of what might have made a practicable steam engine. The illustration, Fig. 2, represents a steam jet issuing from a negro's body, the latter forming a steam boiler heated on a brazier. The blast of steam proceeds from the mouth and is directed against pallets or vanes on the periphery of a large wheel which is expected to turn round and by means of a series of toothed wheels and pinions to communicate motion to

stampers. The inventor also proposed using the engine for the pumping of water.

This invention was an elementary form of steam turbine. Its principal defect was the absence of appliances for making the steam follow the pallets until more of its energy was converted into useful work.

If an ingenious inventor had devoted himself to improving Branca's apparatus, the likelihood is that the reciprocating steam engine would never have been invented, for recent developments of the steam turbine indicate that it is likely to be made as efficient a means of converting heat into work through steam as the best forms of reciprocating engines.

### Necessity Demanding the Steam Engine.

From the time the Christian era began until about three centuries ago there were very few scientific men, and the few



Fig. 2. Branca's Turbine

that existed had other things to do that seemed more important than working out a new motive power. But as war became less and less the principal avocation of mankind, leading minds began to devote their attention to plans for putting the potential forces of nature to useful purposes.

For several centuries various philosophers and experimenters tried to raise water by the use of steam, but they all worked on the wrong line of experiment. They discovered that by filling a vessel with steam and then condensing it, a vacuum was formed which would suck up water a distance of about 34 feet. A series of these lifts was sometimes used to raise water for a considerable distance. Another plan was to apply the steam directly to the surface of the water, as compressed air is now employed at many places for raising oil and for raising water in sleeping cars. Both these methods



were very wasteful of heat but their work was sometimes cheaper than animal power.

Raising water by air pressure has been practiced long, for Hero describes the method in his work already mentioned.

Among the most celebrated modern philosophers who labored to produce power through steam was the Marquis of Worcester, an English nobleman whose principal work was done about 1665. This was the construction of an apparatus which the inventor called "a water commanding engine," and was employed for raising water. Worcester was an inventive genius and he spent a fortune trying to introduce a crude form of steam engine. Circumstances were, however, too formidable for this powerful nobleman. His work was valuable princi-

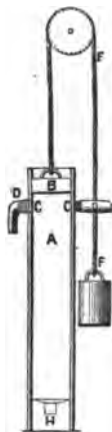

Fig. 3. Huyghens' Gas Engine

pally for paving the road of progress with fractures of ideas on steam.

### The First Gas Engine.

Philosophers who made their mark on formulating a steam engine followed each other in quick succession after Worcester. In 1680 we find Christian Huyghens, a Dutch professor, describing a gas engine, Fig. 3, which he had designed with cylinder and piston, an epochal invention. His plan was to expel the air from the cylinder *A* by a charge of gunpowder. When the gas cooled, the piston *B* would descend, forced down by atmospheric pressure. The apparatus was not practicable, but it possessed the germ which produced the modern steam engine.

### Piston and Cylinder.

This was the piston working in a steam-tight cylinder, a combination that first formed an effectual harness to enable steam to perform work against power transmitting resistance. It is strange, to reflect, how slow the scientists who developed the modern steam engine were to perceive the merits of the piston element, for it had been described in Hero's "Spiritalia sen Pneumatica," and several modern writers had speculated about its use. Naturalists were familiar with the use that bees make of the piston to push honey into the comb, yet engineers appeared to have exhausted every other promising contrivance before they gave the piston a proper trial.

An industrious and ingenious experimenter with steam was Denys Papin, a Frenchman who settled in England about 1680. He soon took a prominent place among the scientists of that period. His principal invention was a vessel which he called a "digester," wherein substances were treated under high steam pressure. He invented a form of safety valve for use on this vessel. He was also the inventor of the two-way cock, the four-way cock and other accessories of the steam engine. These were all ancient devices, however, and may have been copied from old drawings.

A savant of that time, who by fruitful failures narrowly missed making a practicable steam engine, was Thomas Savery, an Englishman born about 1650. He patented a so-called fire engine for raising water by a combination of suction and pressure. Quite a number of his engines were put into operation for draining mines and supplying towns with water.

There were many others who worked at that time trying to devise means for converting heat into work. A great aggregate of small endeavor brought forth useful results and the apprenticeship in inventing was slowly devising the appliances required to make the engine a success after the leading elements were connected together.

### Newcomen's Atmospheric Engine.

A revolutionary advance over previous methods was made about 1705 by Thomas Newcomen, an English blacksmith, who successfully applied a piston to a cylinder. A steam-tight piston working in a cylinder constitutes the most important element of the steam engine. The philosophers who had pro-

posed using a piston before Newcomen's time were not able to devise the mechanical arrangements necessary to transmit the power from the piston. Newcomen built an engine with a cylinder and piston, and connected the latter with a walking beam which had a pump rod connection at the other end. As the art of boiler making was then almost unknown, Newcomen used steam of little more than atmospheric pressure, and employed it to fill the cylinder for the purpose of creating a vacuum by the use of condensing water. A counterweight brought the piston to the top of the cylinder, the part below the piston was then filled with steam, cold water was applied to the outside of the cylinder and piston and the steam was gradually condensed, when the pressure of the atmosphere pushed down the piston, performing a stroke. The strokes originally were

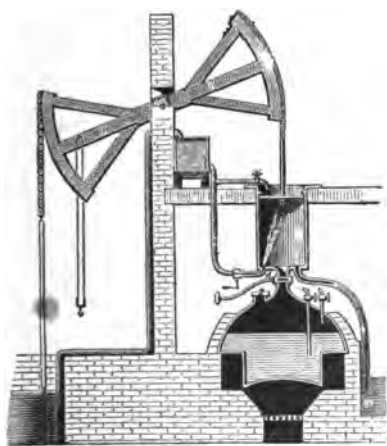

Fig. 4. Newcomen's Engine

not more than four or five a minute. Newcomen's invention is known to history as the "atmospheric engine." Illustrated in Fig. 4.

The first radical improvement effected on this engine was suggested by accident. The piston was kept as nearly steam-tight as possible, and a charge of water was applied on the outside to help in condensing the steam inside. One day it was noticed that the engine began working more rapidly than it had ever done before. On investigating the cause, Newcomen found a hole in the piston packing, which permitted the condensing water to enter the cylinder, where it did its work more rapidly and effectively than when it had to do the cooling

through the walls of the cylinder. After that a jet of water was injected inside the cylinder, which materially increased the efficiency of the engine.

### **First Automatic Valve Mechanism.**

The motion of these atmospheric engines was so slow that the inventor did not consider it necessary to devise any automatic mechanism for operating the valves that admitted steam and water to the cylinder. A boy was employed for opening and closing the valves at the proper times. A boy named Humphrey Potter was valve turner for one of these engines, and he wanted some time for play while at work. Being an ingenious lad, he devised an arrangement of cords which was operated by the walking beam and opened and closed the valves automatically. This simple arrangement nearly doubled the strokes made by the engine. In this humble way originated the automatic valve motion.

### **Improving Newcomen's Engine.**

When, after a persistent struggle, Newcomen demonstrated that his engine could be depended upon to pump water out of deep mines, and that the expense was much lower than that of animal power, there were plenty of men ready to interest themselves in working out improvements on the engine. The principal improvements made on the Newcomen engine were carried out by Henry Beighton and John Smeaton, both famous engineers of their time. Beighton devoted himself principally to making convenient and substantial attachments and mechanism; Smeaton worked to secure greater efficiency for the heat expended in operating the engine. Their labors produced an engine that was fairly efficient, so that within seventy years it attained decided popularity in all countries where the pumping of water had to be done on a large scale. By the year 1780 there were over one hundred Newcomen engines at work in Great Britain, ranging in capacity from 15 to 150 horse power. Many of them had been sent to different countries on the Continent of Europe and a few to the United States.

The weak feature about the Newcomen engine was the great waste of heat caused by cooling the cylinder each stroke for the purpose of creating the vacuum. To remedy this source of waste became the purpose of several engineers and inventors. The most celebrated among these men was James

Watt, a mathematical instrument maker, of Glasgow, Scotland, who is generally credited with being the inventor of the steam engine, which is giving him more honor than he was entitled to.

### Watt Experimenting with Newcomen's Engine Model.

Watt, who was naturally a most fertile inventor and had received a fairly good mechanical training, had a working model of a Newcomen engine in Glasgow University, sent to him to be repaired, and he obtained permission to experiment with it. He had previously made some progress in the study of natural philosophy, and he applied this knowledge to investigating the phenomena of heat producing power through the medium of



James Watt

steam. The discoveries that resulted were in themselves sufficient to make Watt famous.

At that time very little was known about heat, and less about steam. In his experiments with the Newcomen model Watt found out:

1. The capacities for heat of iron, copper and of some kinds of wood as compared with water.
2. The volume of steam as compared with water.
3. The quantity of water evaporated in a certain boiler by one pound of coal.
4. The elasticities of steam at various temperatures greater

than that of boiling water, and an approximation to the law which it follows at other temperatures.

5. How much water in the form of steam was required every stroke by a small Newcomen engine, with a wooden cylinder 6x12 inches.

6. The quantity of cold water required in every stroke to condense the steam in that cylinder, so as to give it a working power of about 7 pounds to the square inch.

All the engineers of reflective minds who had interested themselves in the Newcomen engine saw that using the cylinder as a condenser caused a serious waste of heat; but Watt

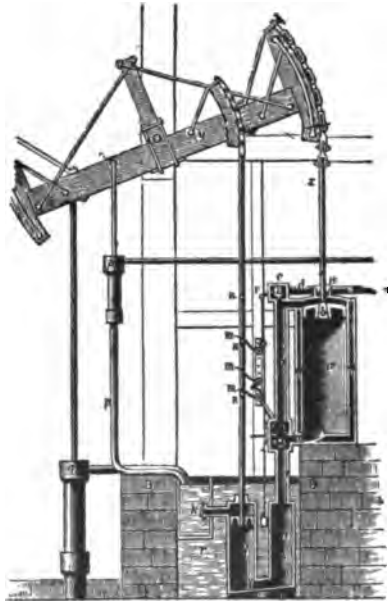

Fig. 5. Watt's Steam Engine

determined with exactness what the loss amounted to. It might have been supposed that Watt, having become acquainted with the elastic properties of steam, would have abandoned the condensing feature and made an engine to work by the direct action of steam, but he appeared to cherish a strong antipathy to high pressure steam, principally because, when he began building engines, no boilers had been made that could safely resist a pressure of more than 10 pounds above the atmosphere. Savery, one of the early experimenters in raising water by the direct action of steam, had several disastrous boiler explosions,

which made many people distrustful of steam pressed above one atmosphere.

Watt was a great believer in utilizing the pressure of the atmosphere with a condensing engine. After cogitating a long time on how to overcome the defects of the Newcomen engine, he conceived the idea of using a separate vessel as a condenser. This resulted in a great saving of heat, and Watt's engine rose rapidly into favor, especially for districts where fuel was expensive.

The mechanism of Watt's first engine is shown in Fig. 5. The steam passes from the boiler through the pipe *d* to the valve *c* to the cylinder casing or steam jacket and above the piston *b*, which it follows in its descent in the cylinder *a*, the valve *f* being at this time open to allow the exhaust to pass into the condenser *h*.

The piston now being at the lower end of the cylinder, and the pump rods at the opposite end of the walking beam *y* thus raised and the pumps filled with water, the valves *c* and *f* close while *e* opens, allowing the steam which remains above the piston to flow beneath it, until the pressure becoming equal above and below by the weight of the pump it is rapidly drawn to the top of the cylinder, while the steam is displaced above, passing to the underside of the piston.

Now the valve is closed and *c* and *f* are again opened and the down stroke is repeated as before. The water and air entering the condenser are removed at each stroke by the air pump *i*, which is in communication with the condenser.

The valves are moved by valve gear on the tappet rod *n n*.

### A Practical High Pressure Engine Proposed.

In 1720 a book called "Theatrum Machinarum," compiled by Leupold, was published in Cassel, which contained illustrations of a great many engineering devices, among them the single acting high pressure engine shown in Fig. 6. A valuable feature connected with this engine was the four-way cock for admission and release of steam. Leupold, who was more of a delineator than an inventor, credited Papin with having proposed the four-way cock. There is no record of the Leupold engine having been built, but the design remained on paper, a valuable suggestion to be put into practice years after it was given to the public.

### The First High Pressure Steam Engine.

In the year 1769, when Watt was trying to improve on Newcomen's atmospheric engine by using a separate condenser to prevent the loss of heat that resulted from condensing the steam every stroke in the main cylinder, Nicholas Joseph Cugnot designed, and, taking Leupold's engine for a model, had built in Paris a steam carriage which he supposed could be used as a gun carriage. The carriage was tried in the presence of the Duc de Choiseul, Minister of War, and of other influential courtiers of the French government. Like most first attempts, this engine was not a success, but the inventor was encouraged to

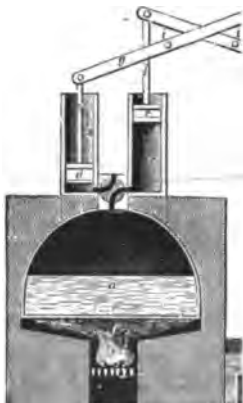

Fig. 6. Leupold's Plan of Steam Engine

try again, and he produced a second engine which is still preserved in the Conservatoire des Arts et Metiers, Paris, a museum where a great many interesting engineering inventions and curiosities are collected, some of them being of particular interest to Americans. I have examined the engine very carefully several times, and consider that it was a wonderfully well designed and substantially built motor, much superior to the first high pressure engines built in England thirty years afterwards.

### Descriptions of Cugnot's Engine.

Cugnot's engine, shown in the annexed engraving, Fig. 7, is a tricycle with a heavy frame, consisting of two strong wooden beams set parallel and extending from end to end, to which the wheels and running gear are secured in a most substantial manner. The single wheel is in front, and carries the engine and



boiler. It has blocks on the periphery for the purpose of biting the ground and preventing slipping, a very necessary arrangement, for the adhesion would not be sufficient to hold down much tractive force. The single wheel is turned by two single acting engines, as proposed by Leupold, one on each side, which operate ratchets that convert the reciprocating motion of the pistons into rotary motion. This arrangement was tried by several improvers of pioneer steam engines before they realized that the crank, whose action in connection with the turning lathe is as old as civilization, was the simplest way to convert to and fro motion into circular motion. To me the boiler seems to be the most defective part of the apparatus. It is made in the form of the cooking caldrons used in the kitchen of feudal castles in olden times. The vessel is a section of a truncated cone made of copper sheets riveted together. At the bottom is a small furnace which was undoubtedly too small to generate a supply of steam for more than a few minutes when the engine was working.

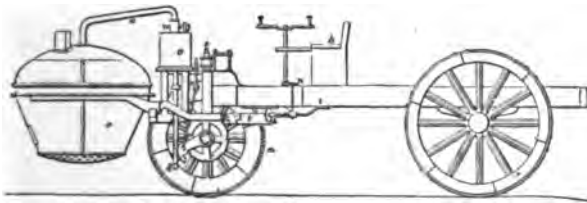

Fig. 7. Cugnot's Engine and Carriage

This shortcoming doubtless proved that the motor could not perform the work for which it was intended.

The wheels are of the kind that were used for field artillery in the seventeenth century, and are very strong, as might be expected, and the whole of the running gear and engine connections were evidently made to endure rough usage. The pioneer locomotives and automobiles or road steam carriages built thirty-five years afterwards in Great Britain caused great annoyance, expense and delay through the parts being too weak, and failures happened so frequently that the introduction of steam into land transportation was delayed for years, but there was no fear of Cugnot's carriage breaking down on account of structural weakness.

The engine was tried but two or three times, and, having accidentally overturned in the neighborhood of which the Madelaine is now the center, it was immediately locked up in the arsenal,

and all hopes of its ultimate success apparently abandoned. The engine in its present state bears evidence, however, that even under the most favorable circumstances it could not compete commercially with horse power; and when we recall the generally wretched state of the roads, alike in France and in England, during the eighteenth century, we have abundant reason for the discredit which then attached to all schemes for steam locomotion.

The political troubles that were brewing in France about the time Cugnot's carriage was tried, gave the military engineer something to do which was considered more important than the work of experimenting with a steam engine. Cugnot lived till 1804, and saw other forms of steam engines made a commercial success.

So far as the mechanical part was concerned, Cugnot's high pressure steam engine possessed all the valuable elements of those that were afterwards made successful by others.

#### Other Efforts.

In 1784 William Murdoch, who first proposed the use of coal gas for illuminating purposes and designed the first apparatus for gas lighting, made a small working model of a road loco-

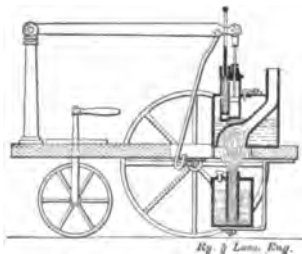

Fig. 8. Murdoch's Model

otive. It was nothing better than a toy, with a cylinder  $\frac{3}{4}$  inch diameter and 3 inch stroke, the steam being generated by a small spirit lamp, but withal an excellently finished miniature engine. British writers have devoted exaggerated attention to this plaything, which exercised absolutely no influence upon the genesis of the locomotive.

When the public first realized that the steam engine was reliable as a power for driving manufacturing machinery, the idea that steam might be used to propel vehicles on common roads began to have advocates. Several attempts of a much more

ambitious character than that of Murdoch were made in Great Britain, before the eighteenth century closed, to produce practicable steam carriages to run on the King's highway, but none of the inventors left a mark upon the development of land transportation.

For a time it looked as if the development of a road engine or locomotive from the stationary steam engine would be as slow a process as was the steam engine in rising from the experimental stage. Schemes for the development of inland transportation by means of the steam engine were rife in Great Britain when the nineteenth century opened, but most of them were of an impracticable character. Although there were numerous



William Murdoch

tramways in use connected with mines, public men, ambitious to improve the methods of land transit, did not recognize that the mining railroads might form the nucleus of a transportation system.

The first suggestion on record for the construction of a railroad to carry merchandise was made before the Literary and Philosophical Society of Newcastle by one Thomas Denton, in February, 1800.

Two years later, Richard Edgeworth, father of Maria Edgeworth, the novelist, suggested that the railroad scheme should be extended for the carrying of passengers.

The proposal that roads with iron rails should be made to carry steam engines as motive power gradually found favor among liberal minded people, but the idea of changing the methods of travel was intensely repellent to narrow prejudice and prevailing ignorance.

In 1803 Prof. John Anderson, of Glasgow, published a most eloquent plea in favor of railways, which had great influence with the educated classes. He wrote:

"If you can diminish only one single farthing in the cost of transportation and personal intercommunication, you at once widen the circle of intercourse; you form, as it were, a new creation—not only of stone and earth, of trees and plants, but of men also, and, what is of far greater consequence, you promote industry, happiness and joy. The cost of all human consumption would be reduced, the facilities of agriculture promoted, time and distance would be almost annihilated; the country would be brought nearer to the town; the number of horses to carry on traffic would be diminished; mines and manufactures would appear in neighborhoods hitherto considered almost isolated by distance; villages, towns and even cities would spring up all through the country, and spots now silent as the grave would be enlivened by the busy hum of human voices, the sound of the hammer and the clatter of machinery; the whole country would be revolutionized with life and activity, and general prosperity would be the result of this mighty auxiliary to trade and commerce throughout the land."

# Early Attempts at Locomotive Construction

## CHAPTER II.

### Work Done By Oliver Evans.

At the period when the inventing of a practicable self propelling steam engine seemed beyond the power of European inventors, an American performed the desired work. This was Oliver Evans, a native of Delaware, who, as early as 1786, applied



Oliver Evans

to the Legislature of Pennsylvania for a patent on a high pressure steam engine. The patent was refused, but that did not discourage Evans, for he proceeded to build high pressure steam engines which were used for mill driving and other purposes.

American inventors were much more successful than their European rivals in constructing boilers that were safe under high steam pressure. European inventors, seeking to improve upon an

existing type, used the domestic caldron as their model, which was essentially weak. Americans, untrammled by precedent, adopted the original idea of pipe boilers, which had great pressure resisting power. Evans used steam of 150 lbs. pressure, and there is no record of any accident to his boilers.

Early in life Evans had the opportunity of examining a Newcomen engine. After studying the working of the engine, he expressed the belief that it would be better to create power by using steam of high pressure direct without complicating the apparatus with condensing appliances. His engine was developed from that idea. Simplicity was his watchword as an inventor.

Poverty prevented Evans from making the success of his high pressure engine that Watt achieved with the condensing engine; but his voice was heard in the wilderness crying that his engine was destined to perform great services for mankind. He realized that it could be employed to propel ships and to drive

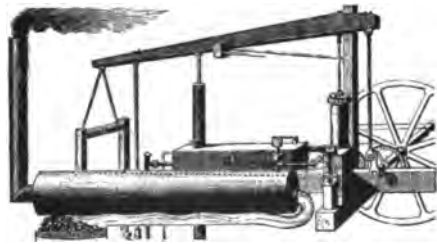

Fig. 9. Evans Columbia Engine

railroad trains, and he did all in his power to make the world of his day understand the benefits his invention was destined to perform in abridging the distances on this great continent.

The Columbian type of engine, built by Evans, had a single vertical cylinder which transmitted movement to a horizontal beam supported on one end by a rocking column which was connected to a main rod that transferred the power to a crank. The "Columbia," as shown in all pictures, had a peculiar valve motion actuated by spur gearing which received motion from the driving axle.

Evans was an inventive genius and one of the seers of mankind, whose vision penetrated the gloom of the future, but his labors and aspirations were strangled by adverse conditions.

"Chill penury repressed their noble rage,  
And froze the genial currents of the soul."

But Evans did not waste his life on saturnine complainings or permit his disappointments to generate resentment towards his fellow-men, as has happened so often with inventors whose work has not been justly appreciated. He devoted himself to various mechanical pursuits and labored very successfully on the improving of milling machinery and in extending the use of his steam engine. He wrote "The Young Steam Engineer's Guide" and the "Young Millwright's Guide," both books having been the best authority for practical men in their day. Had Evans met a powerful coadjutant such as Watt enjoyed in Boulton, the world would now be according Evans proper credit for his work on the improving of the steam engine.

In 1804 Evans built a dredging scow weighing about 4,000 lbs., for the city of Philadelphia. When it was ready for launching he mounted the scow upon wheels and propelled it by the steam engine through the streets of the city. He called the

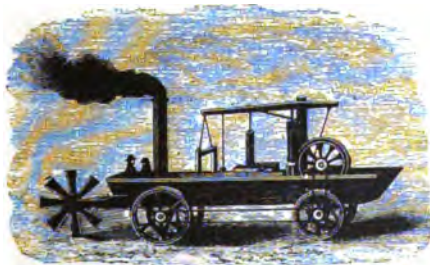

Fig. 10. Evans Oruktor Amphibolis

combination the Oruktor Amphibolis. This was the first motor car to run on American soil.

The first locomotive engine designed to run upon rails was built in 1803, under the direction of Richard Trevithick, a Cornish mine captain, in a blacksmith shop connected with the iron works of Merthyr-Ty'dvil, in South Wales.

#### Where the First Road Locomotive Was Built.

If any student of industrial history, possessed of the poetic instinct of looking into the origin of things, should happen to be in the bustling city of Cardiff, on the Bristol Channel, and wishes to see the place where the locomotive engine had its birth, a trip of 24 miles up a beautiful vale will lead him into the heart of lofty mountains, within whose recesses is built the thriving town of

Merthyr-Ty'dvil, the principal seat of the iron trade of South Wales.

This is no town of mushroom growth. The district is rich in argillaceous carbonate of iron ore, which led to the introduction of smelting furnaces that were worked before the Norman Conquest of England. As Britain advanced in manufacturing arts, iron became a prime necessity, and the iron furnaces of South Wales increased and prospered. The business resulting made Merthyr-Ty'dvil an important town at the beginning of last century.

### An Important Wager.

The residents of the district, many of them the descendants of mighty smiths, those valiant artisans who first took the lead



Richard Trevithick

in developing manual dexterity, appear to have kept informed on the progress of engineering, for one of them, Samuel Homfray, made a wager of 1,000 guineas (\$5,250) that he could convey a load of iron a distance of nine miles by the power of steam alone on a cast iron tramway.

### Richard Trevithick.

Trevithick had been experimenting for several years with a steam carriage for common roads, and there is a working model



of a road locomotive made by him in 1802 preserved in the patent department of the South Kensington Museum, London. His efforts to make a steam road carriage a success were widely known, and he was invited to construct the engine that was to win Mr. Homfray's wager.

In 1802 Trevithick had been granted a patent for a high pressure steam engine, which contemporary writers say was an imitation of engines built by Oliver Evans, of the United States, for stationary engine purposes. There is a statement in Wood's "Practical Treatise on Railroads," published in 1832, to the effect that Trevithick copied Evans' designs of a high pressure engine and used them as his own invention. Trevithick, however, devoted his attention to using the engine for land transportation,

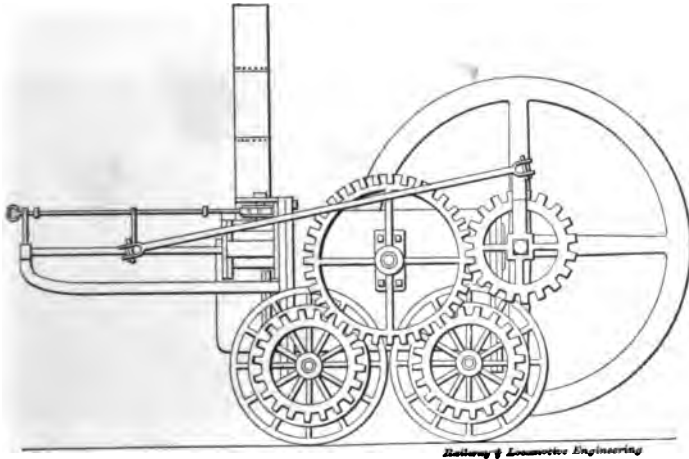

Fig. 11. Trevithick's Locomotive, 1803. First Locomotive Built to Run on Rails

and he made, in 1803, an engine, Fig. 11, that in February of the following year conveyed ten tons of iron nine miles, gaining the wager for his employer.

### A Practical Locomotive.

Although the engine is fearfully and wonderfully made, with its complication of gearing and its great length of stroke, it was a practical locomotive and contained all the elements of the modern locomotive, except the multitubular boiler. This engine had a return flue boiler which was fairly efficient. As shown, the engine was carried by two pairs of wheels, which were 52 inches diameter; the boiler was 60 inches long, and contained

a return flue. There was one cylinder, 8x54 inches, to transmit the power. After being used, the steam was passed into the smokestack, where it aided in creating draft upon the fire.

It will be noted from the annexed engraving, sent to the writer by Mr. Clement E. Stretton, that the rails used on the Welsh tramway had a guiding flange inside. That, of course, obviated the use of wheel flanges.

This engine made a few trips over the rough tramway at a speed of about five miles an hour; but it broke many of the cast iron plates forming the rails and was withdrawn as a commercial failure.

Although his first railroad locomotive was a commercial failure, it was mechanically as successful as anything that followed it in the next 20 years, when the evolution of the steam locomotive was being worked out by the ablest mechanics in the world.



Track That Trevithick's Engine Ran On

The developing of every complex machine has been a labor of years, carried on by many men, and the locomotive engine was no exception. Certain men labored with great success in supplying needed elements, others worked on perfecting old appliances, all making up a complement of masterly achievements; but no one transcended the labors of others sufficiently to have fairly earned the title of inventor of the locomotive.

#### **When Inventions Are Born.**

In the history of the world we see that needed inventions come forth when "nature must obey necessity." When the idea of applying the potential power of heat to lighten the drudgery of mankind was conceived, the hope of its most useful field was in

carrying heavy burdens and in bringing distant places into closer connection. The need of artificial power for transportation did not, however, produce the steam engine. Grim necessity brought it forth when great properties were falling into ruin, and the necessities of civilization were becoming forbidden luxuries, because animal power was incompetent to concentrate great effort into limited space. The steam engine was invented when animals could no longer do the work of pumping water out of deep mines.

It was a foregone conclusion that the steam engine would be applied to transportation purposes as soon as the needs of mankind exceeded the easy capacity of the horse.

A land transportation engine had to be perfected, but for many years those who worked on the problem went through—

“The rueful conflict, the heart riven  
With vain endeavor.”

### **Slow Process of Development.**

After a practical steam engine was invented it took half a century to develop it into a motor suitable for driving manufacturing machinery. Another half century passed before inventors began seriously attempting to devise a steam engine to drive a vehicle on land. A variety of experimental locomotives had been built or patented before the eighteenth century closed, but nothing of a promising nature was produced until Trevithick's engine was built. Although Trevithick abandoned the practice of locomotive building after his first real attempt, the influence of his work was far reaching. The fame of his achievement had gone forth and reached the ears of men who were staring at the specter of ruin in the expense of horse power for hauling heavy loads.

### **Blenkinsop's Engines.**

For the next 10 years after Trevithick's experiment there was considerable effort made to produce an engine that would work satisfactorily. Much attention was devoted to devising means to prevent the slipping of driving wheels, which was a serious trouble with Trevithick's engine due to the tractive power being much too great for the weight available for adhesion. A few engines were built by various inventors, great attention and ingenuity having been devoted to overcoming the reputed tendency of the driving wheels to slip on smooth rails.

One locomotive was built to propel itself by means of levers that acted to imitate the hind feet of a horse. But the most ambitious engines produced to overcome the slipping tendency were built by Matthew Murrery, of Leeds, for J. Blenkinsop, for use on the tramways connected with the Middleton Colliery near Leeds. These engines operated a cog wheel which engaged in a rack rail. They worked quite well and some of them were kept in service for nearly twenty years.

### Blackett's Ambition and Tests.

At that period a very enterprising gentleman named Christopher Blackett was principal owner of the Wylam Colliery near Newcastle-on-Tyne, who was very ambitious to use the steam engine in place of horses. The superintendent of the colliery was William Hedley, a man of some scientific attainments, and the foreman of his blacksmith shop was Timothy Hackworth, who afterward became a celebrated locomotive designer and builder. It is wonderful how some employers attract to themselves men of the most commanding ability in the business. Andrew Carnegie says that the real secret of his success in business was in the selection of the men who were the ablest in their line. That discriminating faculty very often marks the difference between success and failure.

Mr. Blackett had examined the Blenkinsop engines and objected to the rack rail arrangement. To test the necessity for using such an aid to traction, Blackett had windlass handles put on the axles of one of his coal wagons, and with his assistants made tests which indicated that a locomotive would have sufficient adhesion to haul cars on a smooth rail.

### Hedley's Puffing Billy.

With this knowledge acquired, a locomotive was built by Hackworth according to plans made by Hedley. The work was done in the blacksmith shop of the colliery. The first engine was not a success, but his experience with its shortcomings enabled Hedley to build a second engine, which worked fairly well and is now to be seen in the South Kensington Museum, London, bearing the name of "Puffing Billy."

This engine, which was built in 1813, had a return flue boiler, which provided all the steam required. This form of boiler had been used by Trevithick, and Hedley made it a prac-

tical success. It was the best form of boiler used until Robert Stephenson applied the multi-tubular boiler to the "Rocket" in 1829.

### Beginning of the Grasshopper Type.

The "Puffing Billy" was the beginning of a sort of grasshopper type of engine, which, under a variety of modifications, became the fashion and held the field up to 1829, when the directors of the Liverpool & Manchester Railway offered a prize for the most successful locomotive, and a variety of novel types were produced. Hedley's engine was not a model of sim-

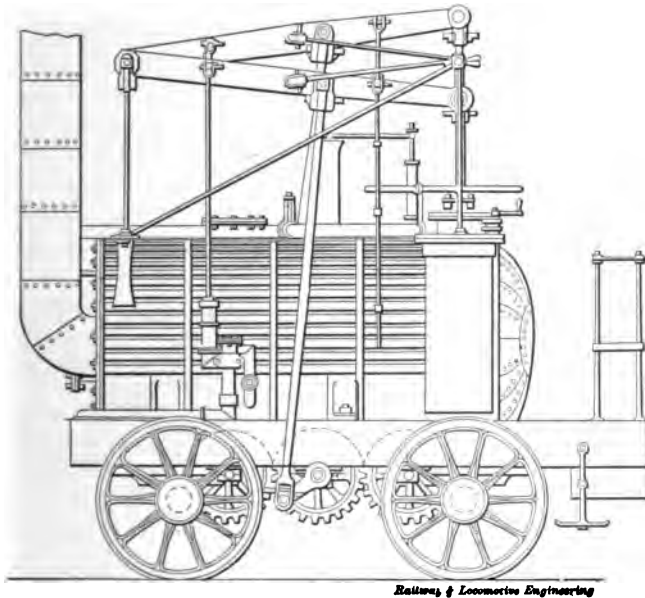

Fig. 12. Hedley's "Puffing Billy," 1813. First Locomotive Used Commercially in Hauling Cars

plicity, but its complications were modest compared to many of its successors. The pioneer locomotive builders did not realize that complicated mechanism was objectionable until sad experience with breakdowns taught them that the fewer parts used which were liable to breakage, the more successful the engine was likely to be. They were the engineers who first learned about the extra destructive effects that result from the engine jolting over a rough track.

### **Puffing Billy in South Kensington Museum.**

During a visit to South Kensington Museum, London, the author wrote:

"To me one of the most interesting relics in the great collection at South Kensington Museum is Hedley's 'Puffing Billy,' built in 1813, and which was the first successful locomotive ever put to work on a railroad track. It was after an examination of this engine that George Stephenson proceeded to build a locomotive of similar style, but which was not such a good working engine as the 'Puffing Billy.'

"The 'Puffing Billy' has a furnace extending about half way into the boiler and a flue leading to an up-take, from which



George Stephenson

the gases of combustion passed through a return flue to the smokestack. The fireman did his work at the smokestack end of the boiler and the engineer sat in front on a wooden seat held by four upright iron posts. The frames are of wood, quite substantial in form and rest upon the axles without the intervention of springs. The four wheels are connected by inside gearing, and the motion is transmitted to a gear wheel upon a separate axle. The tank is an oblong iron box, set behind the coal bunker, the water being carried to the pump by an iron pipe with a flexible leather connection. The engine and tender

are coupled together by means of a chain similar to what is still employed in connecting wagons together on English railways.

"The cylinders are made of wrought iron in two sections, riveted together. The steam chest is a small cavity towards the top of the cylinders, and there is a handle for connecting the valve stem that catches on a vertical plug rod connected with the walking beam.

"The engine shows evidence of very substantial workmanship, although no attempt at finish appears to have been made. The boiler is lagged with wood, held in place very much as is the lagging of modern locomotives.

"The cylinders are 9x36 inches, grate area 6 feet, heating surface 77 square feet. The valve is of the D slide form, worked by a shaft motion. The engine rests upon fish belly rails.

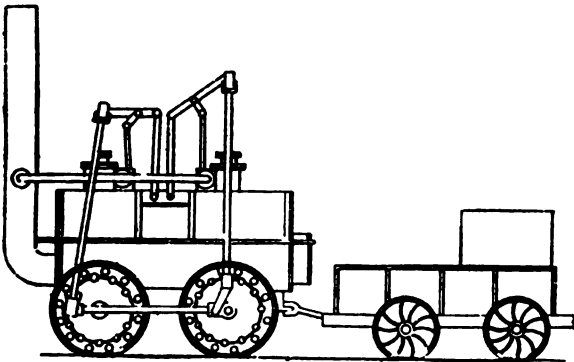

Fig. 13. "Locomotion," Stephenson's First for Stockton & Darlington Railway, 1825

"Two vertical cylinders are used, which, by grasshopper beams, transmit the motion downwards by vertical connecting rods to a shaft with overhanging cranks set at right angles. This shaft carries a spur wheel, which, with four other spur wheels, transmits the motion to the two driving wheels, each 39 inches in diameter."

### Stephenson's First Locomotive.

At the time Hedley's locomotives were built, George Stephenson, an ambitious mine foreman, was employed at a neighboring colliery. In 1814 he built an engine something

like Hedley's, but with a single flue, and it was next to a failure, but Stephenson was wonderfully persistent and was encouraged to try and try again, until within 20 years, in company with his son Robert, he became the principal locomotive builder in the world.

### Discouraging Period of Experiment.

The years from 1803 until 1830 were a period of experiment in developing the locomotive. The history of the locomotive from the time of Trevithick's experiment until the Stephensons achieved their triumphs with the "Rocket" in 1829 presents a record of disasters, failures and of men's perseverance while within the grasp of distressing discouragements, and forcibly illustrates the determined persistence which some men will devote to the practical working out of an idea. It was theirs to

"Arm the obdurate breast with stubborn patience  
As with triple steel."

The locomotive engine was developed into a practical motor by hauling coal on private railways connected with coal mines in the north of England. In 1825 the Stockton & Darlington Railway, a public enterprise, 25 miles long, was opened and operated by locomotives built by the Stephensons and others. George Stephenson & Son had established locomotive building works at Newcastle, and many other firms were by this time turning their attention to making locomotives.

The first locomotive used on this railway was built by the Stephensons and was called "Locomotion." The engine, Fig. 13, worked fairly well but not any better than others built by concerns not so well known.

### The Liverpool & Manchester Railway.

The ancient city of Manchester, the headquarters of the Lancashire textile industries, had long been famous for the enterprise and public spirit of its citizens. This important mart of manufacturing was distant about 30 miles from Liverpool, the nearest seaport, and Manchester's trade languished through the delays and difficulties encountered in transporting goods to and from the port of shipment. Sometimes it took longer to transport a cargo of cotton from Liverpool to Manchester than it did to bring it across the Atlantic in a sailing ship. About the time the Stockton & Darlington Railway was opened a few leading merchants of Liverpool and Manchester organized a



company to construct a railway from Liverpool to Manchester. Permission to build the line had to be obtained from Parliament and stupendous opposition was offered. After a long and vigorous fight the promoters of the enterprise were successful and the railway was constructed.

### Doubt About What Power to Adopt.

Although there were about 50 locomotive engines at work in different parts of England when the Liverpool & Manchester Railway was approaching completion in 1828, there was great conflict of opinion about what form of power was most suitable for operating it. The learned consulting civil engineers favored the use of stationary engines with rope traction, George Stephenson, the level-headed mechanic, who had been engineer of construction, with other practical men, advocated the use of locomotives. After several months of indecision the directors of the company determined to try locomotives and offered a prize of £500 (\$2,500) for an engine that would fulfil certain requirements.

### Rainhill Competition Tests.

Three engines were entered to contest for the prize, all of them decided departures from the prevailing grasshopper types. The "Rocket," built under the supervision of Robert Stephenson, won the prize. A series of very thorough tests was made at Rainhill, near Liverpool, and the "Rocket" was the only engine that went through the trials without some kind of mishap. In a short test of speed without any load the engine attained a speed of  $29\frac{1}{2}$  miles an hour, and with a car containing 36 passengers it made 28 miles an hour.

This extraordinary speed was a startling revelation to the people who had opposed the practicability of locomotives, and did more than all the previous 26 years' experience with locomotives to convince people that a new era in methods of land-transport had arrived.

### From Complexity to Simplicity.

When an engineer examines the "Rocket" and compares it with those previously in use, he seldom fails to observe that a leap had been made from complexity to simplicity of design. The absence of superfluous parts to get out of order doubtless

contributed in no small measure to the success achieved in the trials.

The "Rocket," Fig. 14, possessed all the elements of the modern locomotive, and the work left for succeeding designers to perform was merely that of enlargement of parts and adjustment of increased proportions, to the modifying of forms to suit individual tastes or for special service. The three most important

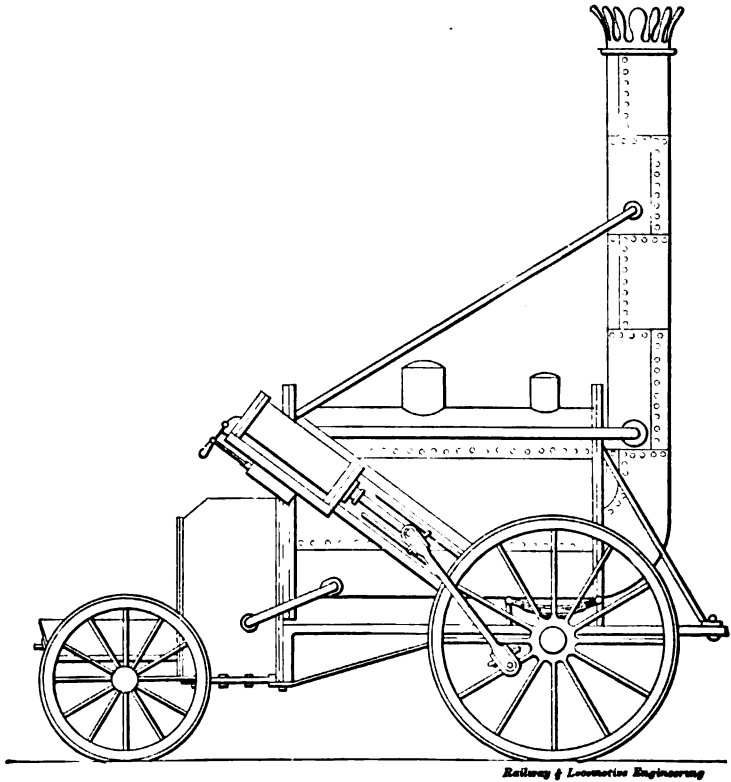

Fig. 14. Stephenson's Rocket, First High-Speed Locomotive

features of the engine were: a multi-tubular boiler, forced draft by the exhaust steam and direct connection between the piston rod and the crank pin secured to the driving wheel. None of these features was original. Trevithick and others had employed the exhaust steam to create draft in the chimney; the multi-tubular boiler had been previously used in the United States and in France, and direct piston and crank-pin connection had been made on several locomotives. It was the com-

bination of three highly meritorious features that made the engine the pioneer of a new type.

### **"Rocket" Model to Pattern From.**

Most of the locomotive builders in Great Britain readily recognized the merits of the very simple engine produced by the Stephensons, and they proceeded to develop their engines on similar lines; but for a few years after the "Rocket" appeared there were a superabundant variety of freak locomotives produced, that testified more to the ingenuity than to the good sense of the inventors.

### **Too Much Ingenuity.**

A conspicuous tendency among the inventors of those days was to multiply complications of mechanism. When an attachment worked indifferently well the would-be improver was certain to add a few parts, until an essentially simple appliance would become a jumble of hopeless complexity. This was particularly the case with mechanisms designed to operate the valves and produce a reversible engine. On examining a production of this kind George Stephenson was moved to remark that the inventor was suffering from excess of ingenuity.

They were like the man who proposed a means of intensifying a red light beacon that the people of a Scottish town were installing for the safety of shipping. It was before the days of stained glass and the lantern glass was covered with a light coat of red paint. The light proved to be rather dim and a discussion arose about it in the town council. Then the wise Provost got up and told them that the remedy was simple. All the glass wanted was another coat of paint.

# Development of Locomotives in Great Britain

## CHAPTER III.

### Experimental Progress.

The "Rocket" was a four-wheel engine, the front pair being the drivers, to which power was transmitted from outside cylinders set diagonally across the boiler pointing toward the back head. The first improvement made on the next engine was to drop the cylinders to a nearly horizontal position at the sides of the fire box.

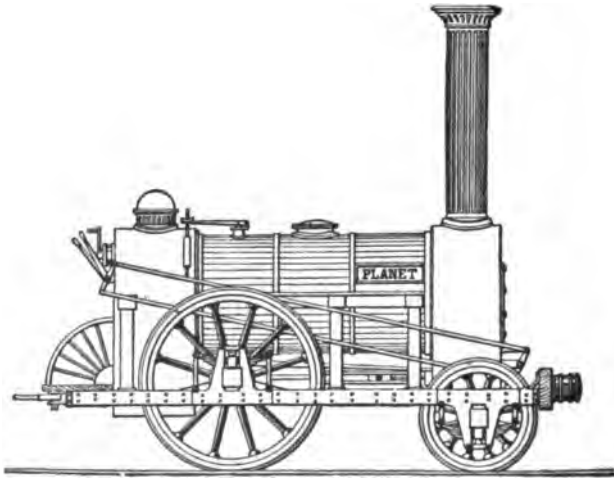

Fig. 15. Beginning of the Established Form

### The Planet Type.

That was followed by placing the driving wheels behind and locating the cylinders in the smoke box, from whence the power was transmitted to the driving wheels through a cranked axle. Outside frames were employed for the first time. The first of this style of engine was built by the Stephensons and was called the "Planet," Fig. 15, and led to what was known as the Planet type. Many engines of this kind were imported into the United States and had considerable influence on the designs of early native-made locomotives, particularly in New England.

### Bury's Engine.

The Stephensons were not, however, the originators of the cranked axle engine with cylinders in the smoke box. That style was designed in 1829 by Edward Bury, and is shown in Fig. 16, although it was not finished until 1834. This engine, or others of a similar pattern, exercised a great influence on American designs. The Bury engine had inside cylinders, inside bar frames and a boiler with hemispherical or "haystack" topped fire box, as our

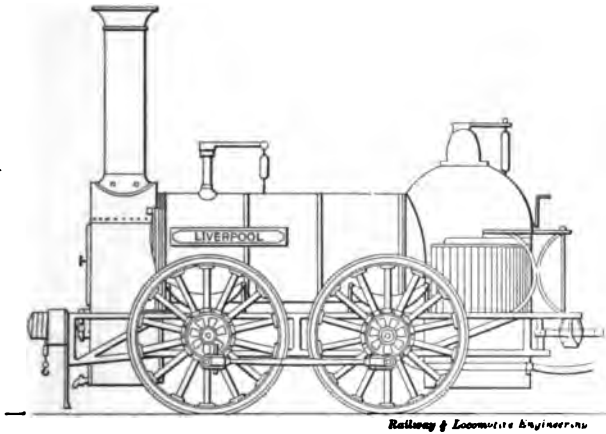

Fig. 16. Bury's Locomotive, 1834

people called it. Our readers will readily identify the Bury engine as the prototype of many early American locomotives.

### Reliability the First Consideration.

For the first ten years after the opening of the Liverpool & Manchester Railway the principal problem worked on by locomotive builders was the making of engines that could be relied upon to haul trains without breakage or failure of some kind. The most elementary forms were adhered to at first, the favorite having a single pair of drivers in front of the fire box and one pair of carrying wheels under the smoke box. The carrying wheels were sometimes displaced for a second pair of drivers, as in Fig. 16, making a four-wheel coupled engine without carrying wheels.

### Diversity in Cylinder Location.

There was considerable diversity of practice in the location of cylinders; some designers putting them inside the frames beneath the smoke box or inside the smoke box, a practice advocated on the ground that the hot location prevented cylinder steam condensation. Outside cylinders were for years most in favor except in the Stephenson works, but they gradually lost prestige, and the British locomotive of the twentieth century has inside cylinders. Outside frames were for years the favorite, but the process of evolution threw them out, and inside slab frames are now almost universally used, with occasionally supplementary outside frames.

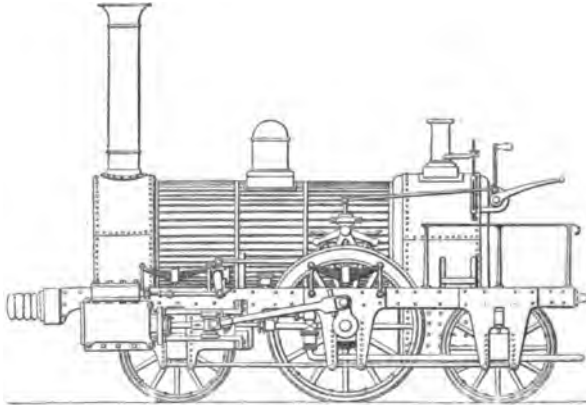

Fig. 17. Forrester, 1834

### Forrester's Boxers.

As nearly all railway companies in Great Britain have followed the practice of building their own rolling stock, there was for years great diversity in the details of locomotives and carriages, but the leading dimensions and the outward appearance were nearly uniform. As early as 1834 the Stephensons, of Newcastle, and Forrester, of Liverpool, built six-wheel engines for the Liverpool & Manchester Railway which became the pattern for passenger service to nearly all British locomotive builders and were the most common form used until within a few years. The Forrester engine is shown in Fig. 17. The cylinders were 11x18 inches, and the single pair of drivers were 5 feet diameter.

This engine of Forrester's was peculiar in some respects. It was the first British locomotive made with outside hori-

zontal cylinders, and it was also the first built with four eccentrics. The valve gear had V-hooks operated vertically, as can be seen in the engraving. The engines were much given to oscillating at high speed, as all outside cylinder engines were with unbalanced driving wheels, and they were known as "Boxers."

### Delay in Counterbalancing Driving Wheels.

Counterbalancing the driving wheels, the improvement that would have rectified the defects of the Boxers, was not tried in England until 1839, several years after it had been successfully carried out in the United States. The introduction of the counter-

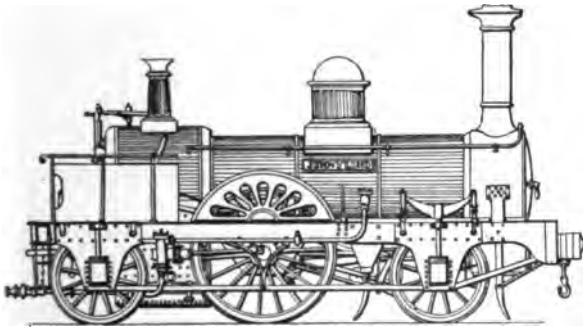

Fig. 18. Joy's Jenny Lind

balance made very slow progress in Great Britain, for we find engravings of fine locomotives built in the 50's that had no counterbalance. This doubtless had a tendency to give outside connected engines an evil reputation.

### Joy's Jenny Linds.

A step marking the progress of 13 years from 1834, when Forrester's first Boxers were made, to 1847, when the "Jenny Linds," Fig. 18, were introduced on the London & Brighton Railway. These engines were designed by David Joy, famous for the valve motion that bears his name, and were quite celebrated for many years. The cylinders were 15x20 inches, the driving wheels 6 feet diameter, the boiler was 11 feet long by 44 inches, and had 124 2-inch tubes. The heating surface was 780 square feet. The steam pressure carried was 120 pounds to the square inch, a very high tension for those days in Europe.

As we journey along the road of locomotive development we have our attention drawn to a few conspicuous designs that made their mark on public opinion of their day, and by that means became historical engines. Certain locomotive superintendents designed locomotives which nearly all other railway companies were willing to imitate, a condition that restrained the tendency of individuals to produce inferior forms through the weak human desire of men to associate their names with something original.

### McConnell's Bloomers.

Three years after the Jenny Linds another favorite appeared in McConnell's "Bloomers," Fig. 19. That class of engine marked

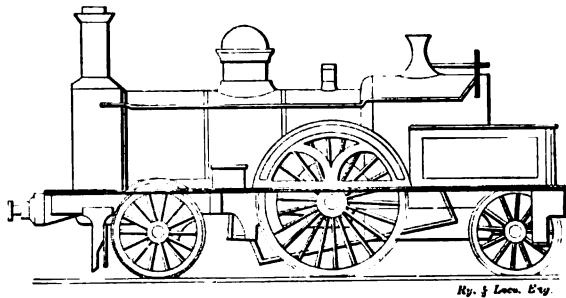

Fig. 19. McConnell's Bloomers

a decided step in advance of Joy's masterpiece, and they exerted considerable influence on the construction of passenger motive power. These engines had cylinders 16x22 inches, driving wheels 84 inches diameter and about 1,150 square feet of heating surface. The engines weighed about 65,000 pounds in working order.

### Lady of the Lake Class.

Twelve years after McConnell's "Bloomers" appeared, Ramsbottom began building the "Lady of the Lake" class, shown in Fig. 20. This style of engine attained great popularity and had a fertile progeny. One was exhibited at the World's Fair, Chicago, in 1893. The engine had cylinders 16x24 inches, driving wheels 90 inches diameter, 1,068 square feet of heating surface, and 15 square feet of grate area; so it was a well designed engine, according to modern standards. Digitized by Google



In the early days of railway operating there was a belief that one form of locomotive would be suitable for operating all kinds of trains, a sentiment that was gradually dispelled by experience.

### Merchandise Engines.

The engines used on the early coal roads were nearly all four-wheel connected, but a few were carried on three pairs of drivers, notably, the "Royal George," Fig. 21, built by Timothy Hackworth in 1826. Hackworth, the builder of Hedley's Puffing Billy, was a rival of George Stephenson in locomotive building, and those familiar with early motive power experiments say that the "Royal George" was the first locomotive that hauled coal cheaper than horses.

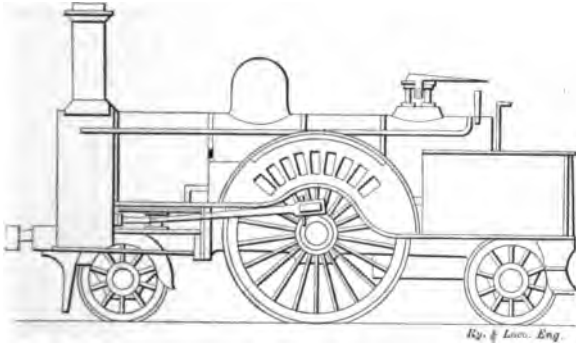

Fig. 20. Ramsbottom's Lady of the Lake

When the railway companies found that a different kind of engine from that used in passenger service was necessary to pull goods trains, four-wheel coupled engines, similar to that illustrated in Fig. 16, page 33, were generally adopted.

A four-wheel engine runs so unsteadily that this type did not last long, even on the slow-going merchandise trains, and we find four-wheel connected engines with a single pair of leading wheels becoming popular for goods service. Some of the mineral carrying roads, notably the Leicester & Swannington Railway, adopted six-coupled engines, but all the merchandise carrying lines held off till 1836, when the Newcastle & Carlisle Railway put in service a six-wheel connected engine, Fig. 22, built by the Stephenson. This engine was called the "Atlas," and had cylinders 14x18 inches and driving wheels 54 inches diameter, and the total weight was under 25,000 pounds, very weak power and light

weight to be carried on three pairs of driving wheels. The tractive power of these engines was 87 pounds for each pound of mean effective steam pressure in the cylinders.

This, however, is an interesting locomotive, since it may be regarded as the first of a type which is the prevailing freight engine in Europe to-day. Changes made have been mostly through increasing the dimensions, adding a sort of cab or weather board and providing improved appliances for operating the engine.

### Kirtley's Engines.

A fair monument marking progress in the design of goods engines may be regarded in a group built by Dübs & Co., Glasgow, in 1869, for the Midland Railway, after the designs of Matthew Kirtley, locomotive superintendent of the road. These engines,

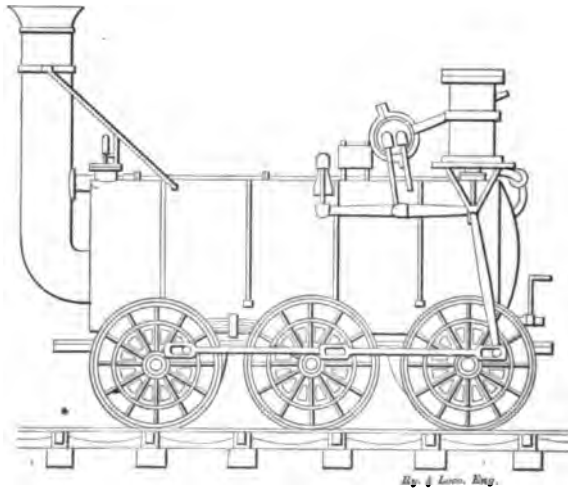

Fig. 21. Hackworth's "Royal George"

shown in Fig. 23, had cylinders 17x24 inches and driving wheels 62 inches diameter, giving 112 pounds of tractive power for every pound of mean effective pressure in the cylinders. This was a very well designed engine having a boiler that provided about 1,100 square feet of heating surface. There has been very little advance made since that time on what may be regarded as the standard freight engine in Europe to-day.

The motive power of European railways is nearly all worked so lightly and so carefully maintained that the engines have what to Americans seems to be an extraordinary protracted life. It

is no uncommon thing to find locomotives half a century old still in service. By looking up branch lines and out of the way service roads, an investigator may find locomotives at work that illustrate the entire history of railway motive power.

### Varieties of Design.

In my remarks on the motive power of Great Britain I have confined myself to the best known types except in giving descriptions of a few conspicuous oddities. But there were many locomotives in use that were different from any of the types described. When I was a young man working on the Scottish North Eastern Railway, about 1860, we seemed to have all forms of locomotives that had been made up to that time. The most common, and a good, all round engine, was built by Hawthorn & Co., Newcastle. It had two pairs of coupled wheels about 60 inches diameter under the boiler and one pair of carrying wheels under the footplate. An

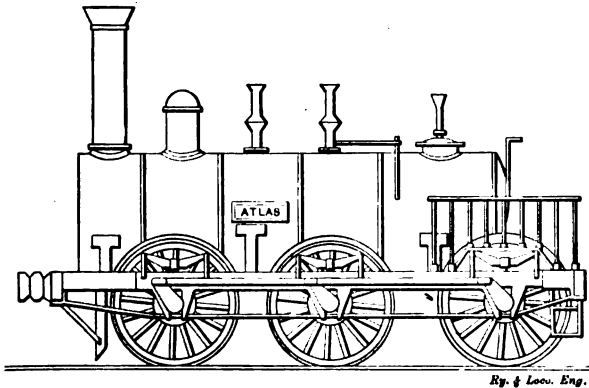

Fig. 22. Stephenson's Established Form of Goods Engine

improved form of this engine, known as the "Gladstone" class, Fig. 24, was brought out by William Strondley, of the London, Brighton & South Coast Railway, about 1885. These engines were quite modern in proportions, and had driving wheels 78 inches diameter as leading wheels. Several other railway companies adopted in a limited way the same style of engine, but there is doubt about the large wheels being safe as leaders. Those using them insist that the engines are perfectly safe, but the defense of the engine is a trifle too profuse, and is something the same as the argument in favor of moguls for high speed passenger service, *Qui s'excuse s'accuse.*

The numerous locomotives built in Great Britain with small trailing wheels gave the designers a fine opportunity to put in a wide fire box, but that was not done until American Atlantic type express engines, first brought out by the Baldwin Locomotive Works, pointed the way. Several continental railways, however, extended the fire box over the trailing wheels before it was done in America.

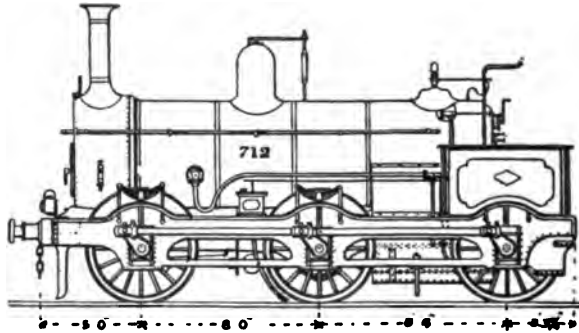

Fig. 23. Kirtley's Goods Engines

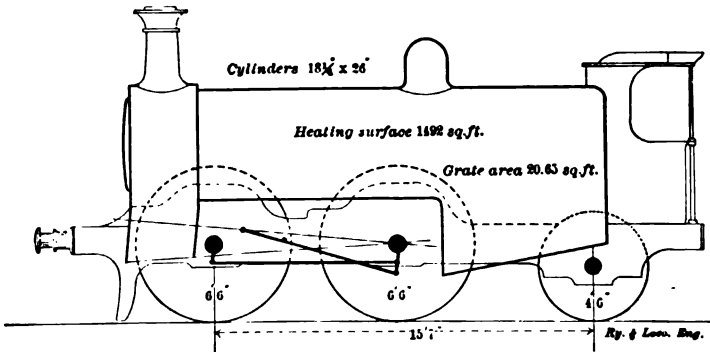

Fig. 24. Strondley's Gladstone Class

A very common old, all-round engine of early days had four wheels connected with a simple pair of small leading wheels, Fig. 25. With a four-wheel truck, this would have been the so-called American engine. The modern British express engine is a direct development of the type referred to.

### The Bogie Truck Adopted.

Within the last ten years of the nineteenth century locomotive superintendents began adopting the four-wheel leading truck, or

bogie, as they call it, and all new passenger engines now have that feature of construction. The passenger engine with a single pair of driving wheels had very protracted popularity, but the introduction of the American style of car carried on four or six-wheel bogies made the trains so heavy that the use of four-wheel connected engines was made imperative, and the leading companies have now adopted four-wheel connected engines with four-wheel truck.

One of the first moves to break away from the beaten path in British locomotive designing was made by James Stirling, of the Glasgow & South-Western, when, in 1873, he built a four-wheel connected engine having a four-wheel truck. This engine, shown in Fig. 26, was very little different from the most advanced modern practice except in size and power. Stirling's example in adopting the bogie was soon followed by other railway companies and that useful method of carrying the front end gradually grew into favor. The long delay in making this important change

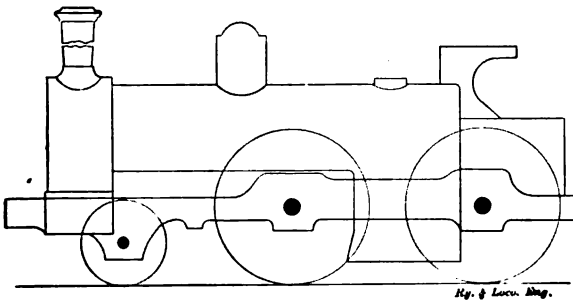

Fig. 25. The Favorite of My Youth

illustrated the strong conservative tendencies of British railway men, for the breakage of the overloaded axle securing the single pair of leading wheels became quite common, and the accidents resulting were generally very serious.

### McIntosh's Dunalistair Class.

The first radical movement to bring British railway motive power up to modern requirements was made by John F. McIntosh, of the Caledonian Railway, in 1896, when he brought out the "Dunalistair," Fig. 27. That type of engine came near to the power developed by the 870 class of the New York Central Railroad, designed by William Buchanan four years previously, and Mr. McIntosh was accused of following American practice.

The leading dimensions of the 870 were: Cylinders, 19x24 inches; driving wheels, 78 inches diameter; heating surface, 1,851 square feet; grate area, 27.73 square feet; pressure carried on boiler, 180 pounds; tractive power per pound of mean effective pressure in cylinders, 111 pounds.

The leading dimensions of the Dunalistair were: Cylinders, 18¼x26 inches; driving wheels, 78 inches diameter; heating surface, 1,403.23 square feet; grate area, 20.63 square feet; boiler pressure, 160 pounds; tractive power per pound of mean effective pressure in cylinders, 111 pounds.

Buchanan's 870 took the lead in the design of 8-wheel express engines in America, and McIntosh's Dunalistair did the same thing in Great Britain.

Imitating American locomotive practice does not seem to be now regarded as much of an offense in Europe, for no

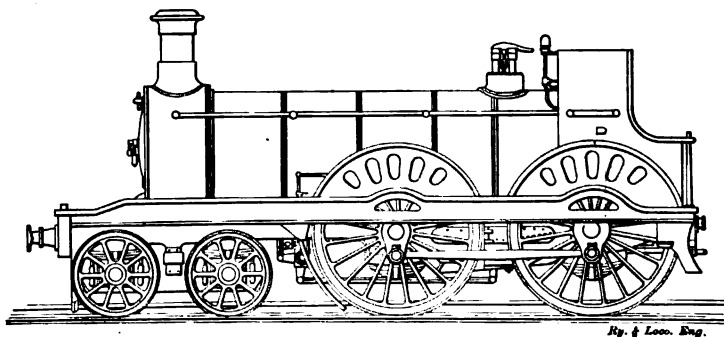

Fig. 26. Stirling's First Bogie Engine

sooner did our Atlantic type of engines 4-4-2 become popular in the United States than the more enterprising railways in Europe adopted the design and used the American name.

### Compounds in Great Britain.

That manifestation of progress represented by the adoption of compound locomotives has not been much in evidence on British railways. In 1878 Mr. F. W. Webb, of the London & North Western, converted an old outside passenger engine into a compound. This engine gave such good results in light service that Mr. Webb designed a new form of compound locomotive with two outside high pressure cylinders and one low pressure cylinder under the smoke box. He built a great

many of these engines and his personal influence compelled a certain degree of success.

In 1897 Mr. Webb stopped building the three-cylinder compounds and introduced a type of four-cylinder compound with all the power transmitted to one axle. He has had sixty of these engines built in the company's shops at Crewe. Some forms of four-cylinder compound locomotives are exceedingly popular on some European railways, but I never heard of any lavish praise being expended on the Webb compounds outside of the designer's immediate friends.

### Worsdell's Compounds.

I have mentioned Mr. Webb's compounds first because he built more of that type of engine than any other British loco-

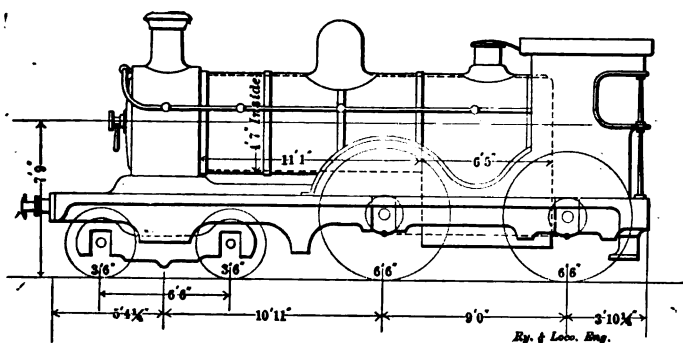

Fig. 27. McIntosh's Dunalistair Class

motive superintendent, but Mr. T. W. Worsdell, of the Great Eastern Railway, was the first to introduce compound locomotives into the British Isles. His compounds have been all of the two-cylinder class with an intercepting valve, something like that used by von Borries in Germany. All the Worsdell compounds have been very successful.

At this date of writing, January, 1906, there seems to be a movement in Great Britain in favor of compound locomotives mostly of the De Glehn type.

Several British railways are now using 4-6-0 engines for passenger service and 8-wheel connected engines are finding some favor for heavy goods traffic.

The scope of this work prevents me from dealing with foreign locomotive practice outside of Great Britain.

# Genesis of American Railways

## CHAPTER IV.

### Requirements of a Prosperous Country.

Lord Bacon truly says there are three things which make a nation great and prosperous—a fertile soil, busy workshops, and easy conveyance of men and commodities from place to place. The history of the world has proved Bacon's words to be true, but there have been nations blessed with a fertile country and busy workshops which have tried to get along without easy means of transportation, because of sectional differences concerning the defraying of the expense of constructing artificial arteries of intercommunication. The regions served by water transport were opposed to building roads for the convenience of localities remote from sea, lake or river, and thus conflicting interests retarded the progress of some countries for the time being and left great spaces of fertile regions undeveloped.

In the course of two-thirds of a century a vast wilderness on the American continent has been changed from gloomy, untrodden forests, dismal swamps and pathless prairies into the abode of a high civilization. Prosperous States, teeming with populous towns, fertile farms, blooming gardens and comfortable homes have arisen in regions where formerly savage men and wild animals were the sole tenants. A powerful factor in effecting this beneficent change has been the locomotive engine.

### Early Pressure of Production Upon Transportation—The Locomotive Due.

Projects for providing facilities of transportation by rail originated almost simultaneously in the British Isles and in the United States. Both countries were badly supplied with highways on which wheeled vehicles could convey heavy loads; both had tried canals and found them unsatisfactory in several respects. The increase of production of commodities, growing faster than the means of moving them, led enterprising men in both countries to look in the same direction for relief.



The conditions of urgent necessity, which led to the inventing of the steam engine, were repeated as the volume of produce and merchandise to be carried went beyond the capacity of water carriage and inferior roads. The steam engine came when great properties were deteriorating because horse power was incompetent to concentrate great effort in limited space. It was a foregone conclusion, that the steam engine would be applied to locomotive purposes, as soon as the horse proved unequal to the work of supplying the motive power for roads and canals.

The application of steam to water transportation delayed for a time the advent of the locomotive, but thoughtful men had glimpses of what the steam engine might do in moving loads on land, almost as early as attempts were made to use steam in propelling boats.

### **Growth of Locomotive Building in the United States.**

The agitation in favor of railroad building began in the United States about the same time as it began in Great Britain, and the machinery for operating them was developed largely by native engineers. Thanks to ignorant writers for encyclopedias and to writers of romancing biographies, there is an impression prevailing that pioneer American railroad engineers were guided entirely by English types of machinery and English methods of construction, which is a fallacy. Those who have studied the subject thoroughly believe that railroads and locomotive building in America would not have been much delayed had Watt never worked on improving the steam engine, and had George Stephenson never been born. Oliver Evans developed the high-pressure, high-speed engine as an improvement on Newcomen's atmospheric engine, and it was much better adapted for locomotive purposes than the ponderous, slow-moving engines that early British inventors had to work after while designing locomotives.

### **General Ignorance About Railways and Locomotives.**

Americans, as a rule, knew very little about what Englishmen had done when they began building railroads, and their first locomotives were purely original. Very little accurate information had reached America concerning what had been done in England before our people entered earnestly into the building of railroads. Before the railroad era there was scarcely any means of spreading scientific

information, and few Englishmen knew anything about how railways were going to be operated when the Liverpool & Manchester Railway was under construction. Six months before that railway was ready for opening, the directors were inundated with schemes for operating the road. There were plans proposed for working the cars by water power. Some proposed hydrogen, others carbonic acid gas. Atmospheric pressure had its advocates, others favored greased cog rails. There was a multitude of counselors who proved nothing, except that even the scientific men of England had no knowledge of what had been done by Trevithick, by Blenkinsop, Hedley, Stephenson, Hackworth, and others.

### **Americans Proceed to Build Railroads.**

That being the condition of engineering knowledge in Great Britain, it was not surprising that Americans had to fall back upon their own resources, when they proceeded to build railroads and to put them into operation. The nation has always been celebrated for self-reliance, and the pioneer railroad builders pushed along without hesitation, crossing the bridges of difficulty when they were reached. So far were they guiltless of imitating English methods, that they built and began operating the first railroad in the world, ever projected for general traffic, and worked it with motive power of native design. That was the Baltimore & Ohio Railroad, which was chartered in 1827 and part opened for business in 1830.

### **The Railroad Track.**

The railroad structure provided a way for the wheels of a vehicle to run upon a smooth, hard surface, where obstacles to progress, such as sinking of the wheels into soft places and mounting over stones or other projecting obstructions, would not be encountered. Such roads were to be found in various localities hundreds of years before the steam engine was invented. There are many traces of what were really stone railroads to be found in parts of Asia and Africa, where an advanced civilization flourished thousands of years ago. The rows of huge stone blocks, worn with myriads of wheels, are in many places the most substantial traces of an enterprising people long passed away. The writer has seen in the streets of Italian cities stone blocks laid down parallel, with a depression to keep the wheels of vehicles in place, and these make as smooth a roadbed as the inside surface of car-track rails provides for the truckman of our large cities.

### Need of the Locomotive.

The nineteenth century had not advanced many years, when people in the United States began to realize that something better than canals were necessary, as a means of intercommunication if great parts of the nation's territory were to be opened up to settlement and civilization. There were numerous navigable rivers and long-reaching lakes on this continent, but geographically they are far apart, and there is no means of reaching vast regions except by land transportation. To the ordinary thinker, a system of substantial macadam roads would have solved the difficulty as far as draft animals could have aided, but these roads were not tried to any extent, for the cost of making them was beyond the means of a thinly-populated country, where in many places stone was very costly and labor was exceedingly dear.

### The Pinch of Necessity Brought the Locomotive.

The pinch of necessity wonderfully quickens the inventive faculties. Long before a mile of tramway was built in the United States in connection with coal mines, engineers and far-seeing public men were discussing the possibilities of the steam engine as a means of accelerating land travel, and projects began to be agitated in different States to construct railways, or tramways, on which the steam engine could do the work of hauling the cars.

Those who looked favorably upon steam engines as motive power on railroads, were a small minority, and they were considered by the majority as cranks and visionaries. Those regarded as sensible, progressive men, a little ahead of their times, favored horses for motive power.

The problem that public men were interested in was: How are we going to move our merchandise and coal and ore to the nearest point of water navigation? The transportation of passengers received little consideration from the early railroad schemers.

The need for the locomotive was much more urgent in the United States than it was in any other country. There were long stretches between western rivers and eastern estuaries that needed to be connected. There were no well-constructed roads of any consequence, and such roads, had they existed, could not have offered rapid transportation, so the railway was the chief hope of connecting the remote territory with markets and the seaboard.

### First Railroad Chartered for General Transportation.

The South Carolina Railroad Company was the first in the world to decide that its railroad should be operated by locomotives. Its construction was begun in 1827, but delays occurred which prevented it from being opened until part of the Baltimore & Ohio Railroad was in operation. Before the two railroads named had a working section finished, there were several short railways in use, horses being the motive power. One was the Phillipsburg & Juniata Railroad, in the Allegheny Mountains, and another was near Mauch Chunk, Pa.; but the best known of the first experiments in railroad operating was at Quincy, Mass.

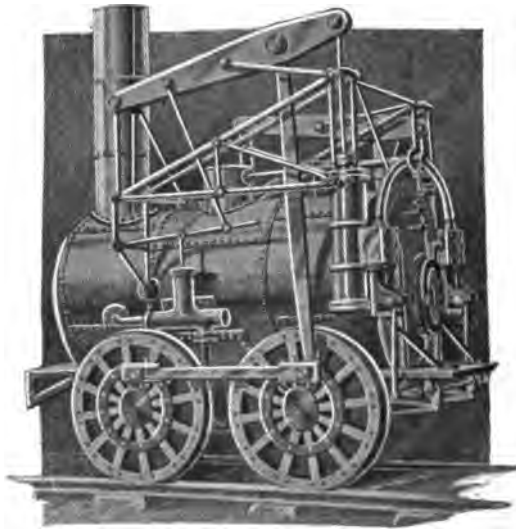

Fig. 28. Stourbridge Lion

This railroad was purposely built to convey granite to be used in building the Bunker Hill monument from the quarries to the Neponset River. The patriotic impulses of the people were greatly stirred by this enterprise and helped in raising the fund necessary to try a new method of land transportation. In 1827 a piece of railroad was made by the Delaware & Hudson Canal Company for the purpose of conveying their coal from the mines to Honesdale, Pa., the junction with the canal.

As early as 1815 the Legislature of New Jersey passed an act creating a company to construct a railroad from the Delaware

River, near Trenton, to the Raritan River, near New Brunswick, but the enterprise was of a political character and came to nothing.

### **The "Stourbridge Lion."**

The first locomotive on the American continent that was used to run on rails was brought from England by the Delaware & Hudson Canal Company and was tried near Honesdale. The engine was selected by Horatio Allen, a celebrated pioneer engineer, and brought to the United States under his supervision. He acted as engineer in some trials made in August, 1829. The engine was of the vertical cylinder type favored by early locomotive builders for hauling coal. The engine weighed 7 tons and was reported by Mr. Allen to be too heavy for the trestles. That report closed the usefulness of the "Stourbridge Lion" (Fig. 28), as the engine was called, and it was laid away and gradually dismantled. In 1905 the boiler and other parts of this celebrated locomotive were collected in various parts and sent to the Smithsonian Institute, Washington, and put together, making, with the addition of a few new pieces, a complete engine.

### **Americans Ready to Design and Build Locomotives.**

This failure did not dishearten the men who were advocating the construction of railroads. The first thirty years of the nineteenth century were for Americans a period of speculation about the probable success of railroad building and of the utility of the locomotive. But before the third decade was ended railroad construction was going on in various parts of the country.

The average American knew very little about what Englishmen had done in the same line when they began building railroads; they had very vague ideas about foreign locomotives and regarded the "Stourbridge Lion" as a freak. In consequence of this the first American-built locomotives were purely original productions of native talent.

### **Agitation in Favor of Railroad Building.**

While the Baltimore & Ohio Railroad was the first in the United States to have a section opened for regular traffic, and the first railroad on which a native-built locomotive did useful work, the promoters of other railroad enterprises were not waiting to see if the Baltimore undertaking would be successful. Before 1830 ended the Legislature of nearly every State in the Union had granted

charters for railroads, and many of them were in course of construction before the year was far advanced.

### **Effect of Canals on Trade.**

The tendency of canals was to divert commerce toward certain centers and consequently deprive other places of business which had previously been theirs. There had been considerable mileage of canals constructed before 1830, and much more was projected and was under way. The towns that could not receive benefit from canals, naturally looked to railroads to help them and bring to their warehouses commerce that the waterways were trying to divert. This was what stirred up the business energy of Baltimore, in favor of a railroad to establish transportation between the Susquehanna and the Ohio Rivers. The road, in fact, from its inception, was intended as a rival to the Chesapeake & Ohio and of the Erie Canals.

### **New York City Against Railroads.**

The apathy which the people of New York, the most important city in the country, displayed toward railroad building, was due to the fact that they supposed the Erie Canal, constructed by other people's money, would bring them all the business they could handle. The rich city of New York has always taken a discreditable position concerning railroad property. Its politicians have always succeeded in taxing the State people heavily to maintain the Erie Canal so that it might depress railroad rates; yet the railroads have at all times moved passengers and freights cheaper than the subsidized canal.

### **South Carolina Railroad.**

About the time that the good people of Baltimore were preparing to invest their capital in the construction of a railway, the citizens of Charleston, S. C., were laboring to establish railroad communication with Hamburg, on the western border of the State, 136 miles away. A charter for the road was obtained in 1827 and renewed for some reason in January, 1828. The charter name was "South Carolina Canal & Railroad Company."

The projectors of the road appeared to have been enterprising and sagacious business men, quite worthy to rank with modern railroad trust builders, for one of their first moves was to induce the Legislature to pass a bill exempting the property of the company from taxation.

The enterprise of building a railroad to the western part of the State was very alluring for Charleston. The town is built in a region of swamps that brought little local trade, but by reaching out to the uplands the city would draw, not only a large shipping trade from good cotton-raising districts, but would also bring purchasers for the goods handled by its enterprising merchants. The ground was of such a character that a great part of the road from Charleston to Hamburg had to be built on trestle work. That did not discourage the promoters of the scheme, however, for pine was plentiful and cheap and labor cost less than in any other part of the country.



Fig. 29. Horse Locomotive

### Horse and Wind Power Cars.

The company was managed at first by local talent, and one of the first acts of the directors was to offer a prize of \$500 for the best locomotive driven by horse power. American ingenuity was quite equal to meet this requirement, and the prize was awarded to C. E. Detmold, who invented a horse-driven motor worked on an endless chain platform. This motor carried twelve passengers and attained a speed of twelve miles per hour. Its performance was regarded as satisfactory.

A sailing car was also tried on this road, but its career was even shorter than that of one tried by the Baltimore & Ohio Railroad about the same time. The crew who engaged to manage it on the trial trip were more accustomed to manage horses than sails. When going before a fresh breeze at about twelve miles an hour, and

loaded with fifteen passengers, the mast went by the board, carrying the sail and as many of the passengers as it could scoop off. That broke the taste of Charleston citizens for sailing on land.

### Horatio Allen Appointed Chief Engineer.

The impression having reached the directors that something better than local talent was necessary, for the officers performing scientific duties, the position of chief engineer was offered to Horatio



Horatio Allen

Allen, who probably knew more about railroads than any man in America at that time. Mr. Allen accepted the place, and within thirty days made an exhaustive report recommending the kind of road to be constructed and the kind of power to be employed in operating it.

Mr. Allen had spent several months in England the previous year studying the construction of railways and of the power employed in operating them. He had been commissioned by the Delaware & Hudson Canal Company to purchase some locomotive engines for the piece of railroad they intended to build, so that he probably enjoyed the best of opportunities to study the design and proportion of the engines under construction in the few shops in the British Isles then devoting themselves to that kind of work.



### Allen Recommends Locomotive Power.

In reporting to the directors of the Charleston, South Carolina, Canal and Railroad Company, Mr. Allen urged that a structure sufficiently strong to carry locomotives should be built, and that locomotives be employed to operate it. The directors met on January 14, 1830, and the Chief Engineer's report was fully endorsed.

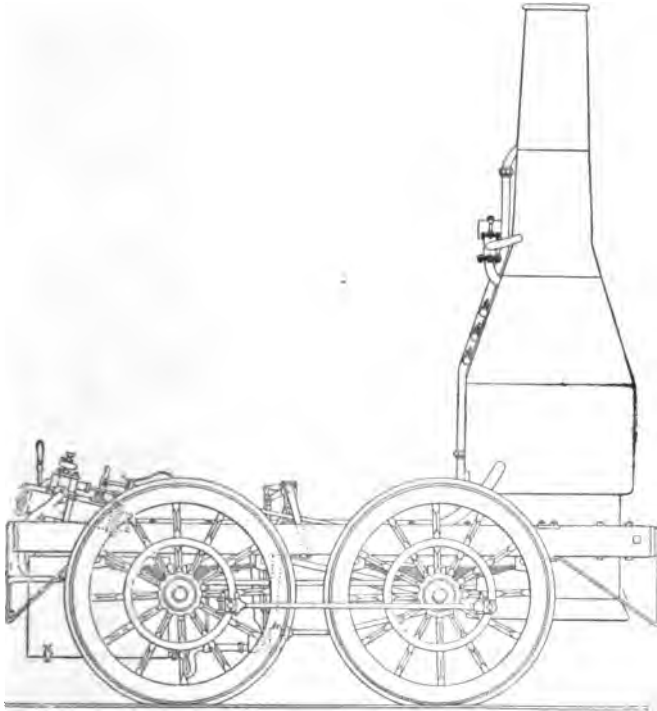

Fig. 30. The "Best Friend of Charleston"

A resolution was adopted which said that the locomotive alone should be used upon the road, and in selecting that power for its application to railroads, the maturity of which will be reached within the time of constructing the road, would render the application of animal power a great abuse of the gifts of genius and science. This was the most progressive action hitherto taken by a board of railroad directors, and the Charleston Railroad was the first in the world to decide positively that the road should be operated by locomotive engines.

### Allen on the South Carolina Railroad Power.

When the Erie Railway was completed to Dunkirk a great celebration was held and Mr. Allen was one of the principal speakers. Concerning his connection with the Charleston Railroad he said:

“At the same period, that was, prior to the great locomotive trial in England, when the Baltimore & Ohio Railroad Company were so strongly impressed in favor of horse power, it became necessary for me, as engineer of the South Carolina Railroad Company, to decide for what power that road should be built. The road was one hundred and thirty-six miles long. From the character of the country the plan of the road would be naturally influenced by the

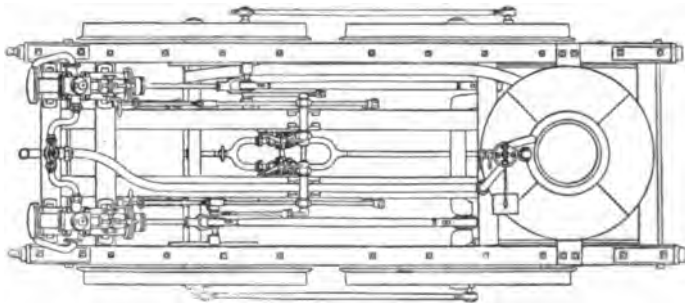

Fig. 31. Plan of the "Best Friend"

kind of power adopted. Stationary power was out of the question, but the opinion was held by many of great intelligence that horse power should at least be commenced with. In the report I read on this important question, I submitted such comparative estimate of the results of the horse power and locomotive power, as the information then to be had appeared to me to sustain. That estimate was in favor of locomotive power, but I rested the decision of the question on the position that, what the performance of a horse was and would be, every one knew; but the man was not living who would undertake to say what the locomotive was yet to do, and I may add that, after more than thirty years have elapsed, during every one of which the soundness of this position has gained new grounds to sustain it, he would be a bold man who would say that we had attained the limit in the performance, and especially in economy of performance, of this great mechanical blessing to man-

kind. In the recommendation of this report in favor of locomotive power, the board of the South Carolina Railroad Company unanimously concurred, and as this decision was the first on any railway built for general freight and passenger business in this country or in England, it has been referred to as one of the interesting facts in the early history of railroads."

### Merchant Designed First American Locomotive.

The spectacle which was witnessed, of a merchant, unaccustomed to mechanical pursuits, designing the first locomotive for the

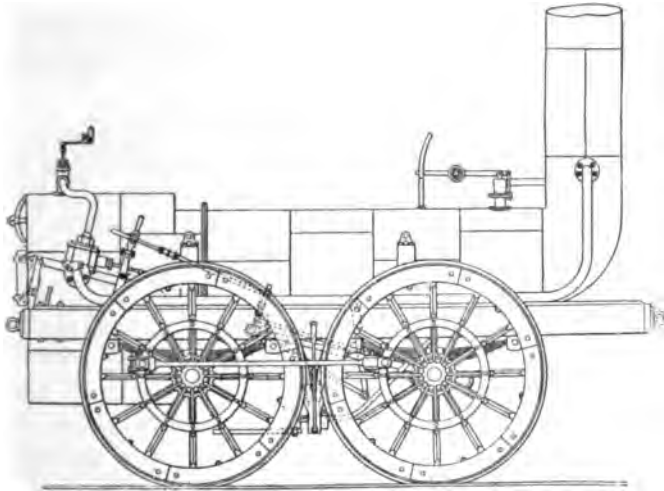

Fig 32. The "West Point"

Baltimore & Ohio Railroad, was nearly paralleled on the Charleston Railroad. Although the advice of Chief Engineer Allen had been followed when he recommended the use of steam locomotives for power, he did not at first control the designing or selection of the engines. When the company decided to purchase a locomotive the duty of selecting it was conferred upon E. L. Miller, an influential citizen of Charleston, who engaged Mr. Detmold, who had designed the horse-locomotive, to design one to be driven by steam. Between them they produced designs of a locomotive which they guaranteed to haul a load three times its own weight at a speed of ten miles on hour.

Mr. Miller proceeded to West Point Foundry, New York, and

superintended the construction of the engine, which was wisely named the "Best Friend of Charleston." The reading world is quite familiar with the appearance of that engine, here illustrated after the original drawings, which are in the possession of the American Society of Civil Engineers.

### Details of the "Best Friend."

A curious thing about the design under the circumstances of its origin is, that it shows decided originality and displays a high order of engineering ability.

Particulars of the engine were given in a letter written in 1859 to William H. Brown, author of the "History of the First Locomotives in America," by David Matthew, one of the pioneer loco-

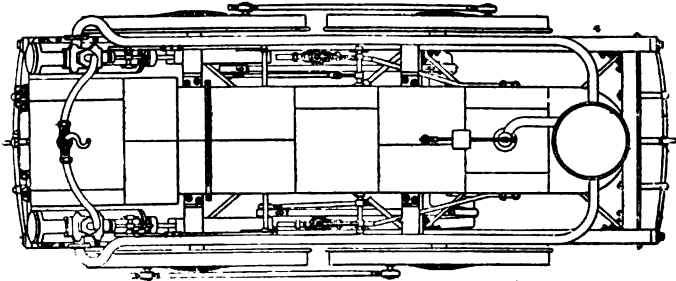

Fig 33. Plan of the "West Point"

motive engineers, who was foreman of machinists in West Point Foundry, Beach street, New York City, when the "Best Friend" was built. The salient parts of Mr. Matthew's letter reads:

"The 'Best Friend' was a four-wheel engine, all four wheels drivers. Two inclined cylinders, at an angle, working down on a double crank, inside of the frame, with the wheels outside of the frame, each wheel connecting together outside, with outside rods. The wheels were iron hub, wooden spokes and feloes, with iron tire, and iron web and pins in the wheels to connect the outside rods to.

"The boiler was a vertical one, in form of an old-fashioned porter bottle, the furnace at the bottom surrounded with water and all filled inside full of what we called teats, running out from the sides and top with alternate stays to support the crown of the furnace; the smoke and gas passing out through

the sides at several points, into an outside jacket, which had the chimney on it.

"The boiler sat on a frame resting upon the four wheels with the connecting rods by it to come into the crankshaft. The cylinders were about 6 inches bore and 16 inches stroke. Wheels about  $4\frac{1}{2}$  feet in diameter. The whole machine weighed about  $4\frac{1}{2}$  tons."

As the tons were long, or 2,240 pounds, the total weight was about 10,000 pounds. Figured by our present rules, the traction force with 50 pounds boiler pressure, was about 400 pounds. Running at a speed of 20 miles an hour and working steam at three-quarters' stroke, the engine would develop about 12 horse power. The finished "Best Friend" was different in some respects from the drawings reproduced, but the general design was the same.

The boiler, which was decidedly original in design, appears to have been the prototype of the Hazleton and other boilers which have teats as evaporating surface. It was perfectly efficient and steamed well with rich pine wood, the fuel used.

The engine was taken by ship to Charleston and put to work in November, 1830. The wheels proved too weak for the lateral strains put upon them in rounding curves and had to be rebuilt with wrought iron spokes.

When the "Best Friend" arrived at Charleston about seven miles of the road had been finished, and the engine was put to work hauling material for construction.

### "Best Friend" Highly Efficient.

The engine proved highly efficient and doubled the stipulated power and speed. The engineer who first ran it wrote that the engine hauled forty or fifty passengers on four or five cars at from 16 to 21 miles an hour, and ran at a rate of thirty-five miles an hour without a load.

### Boiler Explodes.

About seven months after the engine was put to work, the negro fireman, who was left in charge while the engineer superintended the loading of cars, annoyed by the noise of the safety valve, fastened the valve down with the result that the boiler exploded. The excessive pressure fractured the crown sheet and the reaction threw the boiler in the air.

### The First Master Machinist.

The engine was afterwards rebuilt in the shop of Thomas Dotterer, a Charleston mechanic. The work was done under direction of Julius D. Petsch, who applied straight axles with outside cylinders and cast-iron wheels. The rebuilt engine was christened the "Native" when it first emerged from the repair shop; but that name was afterwards changed with decided propriety to the "Phœnix." Mr. Petsch, who had displayed so much skill in re-designing and rebuilding the engine, was appointed master machinist of the road and he was the first man in the world to hold that title.

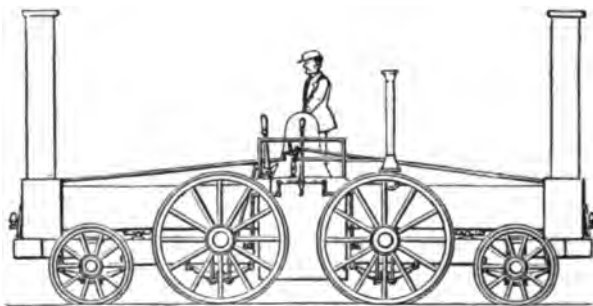

Fig. 34. The "South Carolina"

### The "West Point."

Before the "Best Friend's" boiler exploded another locomotive was ordered from the West Point Foundry. Mr. Miller again being chief designer. This time he specified an engine with a horizontal boiler, but otherwise the frames, wheels and cylinder connections were very similar to those of the "Best Friend." The boiler had a square wagon top firebox with no dome on top. Six or eight tubes about three inches diameter and six feet long conveyed the products of combustion from the firebox to the smoke box, which was merely the base of the smokestack. The engine was called the "West Point."

That engine went into service early in 1831, and did the work required quite satisfactorily. In a public test made shortly after being received, it hauled four passenger cars, carrying one hundred and seventeen passengers, nine persons more on the engine, and a barrier car carrying six bales of cotton, two

and three-quarter miles in eleven minutes. The "barrier car," which was always loaded with cotton, was a regular feature of all passenger trains at that time and was advertised as being used to protect passengers *when the locomotive boiler exploded*. An explosion seemed to be regarded as a regular occurrence.

### Horatio Allen's Double-Ended Engine.

After the "West Point" was received, Horatio Allen, the chief engineer, undertook to design a locomotive, and one was built at the West Point Foundry in 1831.

This was a double-ended locomotive, Fig. 34, called the "South Carolina." The boilers consisted of two barrels set side by side connected at one end by a single firebox and at the other by a smoke box. The engine had eight wheels arranged in two trucks, one pair of driving wheels located close to the firebox and one pair of small carrying wheels close to the smoke box forming a truck. Each truck had one cylinder which was in the middle of the engine and attached to the smoke box. The driving axle had a crank in the middle, to which the connecting rod was attached by a ball-joint.

The engine was built and put to work, but, like most other freak locomotives, most of its time was spent in the repair shop. The "South Carolina" was not a practicable locomotive for working trains, but it possessed the feature that was afterwards worked out into a successful double-ended articulated engine.

### Baldwin's Second Engine.

When the railroad company was ready to order their fourth engine, which was in 1833, the services of Mr. Miller were again sought, and he went to Philadelphia and consulted with Mr. M. W. Baldwin, who had built one locomotive, and was inclined to engage in the work as a regular business. Messrs. Miller and Baldwin consulted together and examined several locomotives that had been imported from England. The result of their deliberations and examination of engines was, that Mr. Baldwin agreed to build a locomotive for the South Carolina Railroad.

The engine built was called the "E. L. Miller," Fig. 35. It had outside frames and a single pair of drivers behind the boiler and a four-wheel truck under the smoke box. The cylinders were set on top of the frames at the sides of the smoke box, and transmitted the power to half-cranks inside the driving wheels.

The boiler was of the Bury or hemispherical type, with a dome on top.

This engine was delivered in March, 1834, and became one of the most famous locomotives of its day. Its form was standard with Baldwin until the necessity for heavier power gradually led to radical changes of design.

This story as told will give an idea of how far the development of the locomotive was worked out and influenced by the



Fig. 35. Baldwin's Second Engine

pioneers connected with the Baltimore & Ohio and South Carolina Railroads. When the "E. L. Miller" was put in service, the South Carolina Railroad was the longest railroad in the world.



# Connecting the Ocean with Western Rivers

## CHAPTER V.

### The Baltimore & Ohio.

One of the most ambitious projects in railroad building, first ready for operating was the Baltimore & Ohio Railroad, which was chartered in 1827 and partly opened in 1830. The objective point of that railroad was the Ohio River, a very comprehensive scheme, since merchandise or other products of the South would reach the consumers of a stupendous area of country.



Peter Cooper

The enterprise undertaken by the people of Baltimore in establishing railway communication between tidewater and the Ohio River, with its far-reaching water connections, was the greatest undertaking the world had then contemplated in land transportation. The people of New York were enjoying

the commercial advantages of the Erie Canal, built at the expense of the State, and the public spirited merchants of Baltimore proposed drawing upon their own resources to build an artery of commerce that would rival any artificial waterway.

### A Tortuous Route.

The route located involved the use of a great many curves and grades that were considered so formidable that few people believed the road could be operated by steam. But others had clearer vision. Peter Cooper, afterwards celebrated as a great philanthropist, was then a merchant in Baltimore, deeply interested in the prosperity of the city. He believed that the road could be successfully operated by steam and proceeded to prove it. Being a man with some mechanical ability, he designed and



Fig. 36. Cooper's Tom Thumb

supervised the building of a small locomotive whose working presented the very best arguments in favor of a locomotive. Seventy years ago nearly all Americans were amateur mechanics, so it excited no surprise that a merchant should design a locomotive.

### Cooper's Engine.

Cooper's engine was the "Tom Thumb," Fig. 36, a remarkably tiny locomotive with one upright cylinder  $3\frac{1}{4} \times 13\frac{1}{2}$  inches, and an upright boiler having tubes made from gun barrels. Draft for the fire was maintained by a revolving fan. It performed the duties for which the engine was built, most of them having been of a missionary character. It proved that steam

power could be used to operate the Baltimore & Ohio Railroad, and revived the spirits of the promoters of the enterprise who were becoming despondent about the prospects of the property. The "Tom Thumb" was little bigger than a modern hand car and was only about  $1\frac{1}{2}$  horse power, but its design seems to have exerted considerable influence on our early locomotives. Cooper claimed no originality in using tubes for the boiler, for Nathan Read, of New England, had built multi-tubular boilers years before.

### **Sentiment Favoring Railroads Growing.**

The sentiment in favor of railroad building developed very rapidly in the United States after the shortcomings of canals had been plainly demonstrated. The men who took the lead in advocating railroads were the most influential and intelligent men in the country, having clear views about what they wanted. When DeWitt Clinton, in 1812, was urging through the New York legislature the act for the construction of the Erie Canal, Colonel John Stevens, of Hoboken, insisted that he could build a railroad on which cars would be drawn by steam locomotives at a cheaper rate, and at a much higher speed than canal boats. He submitted particulars of his plans, and they did not differ much from the railroads that were subsequently built.

### **B. & O. Directors Offer Prize for Locomotive.**

Shortly after the experiments with Peter Cooper's model locomotive, the management of the Baltimore & Ohio advertised, offering a premium of \$4,000 for a locomotive, built in the United States, which would draw fifteen tons, gross weight, at fifteen miles an hour. In due time this offer brought to the company five locomotives, all built at different places, all different in design, and none of them imitating British models.

### **Johnson's Engine.**

The first engine offered in the competition was made by George W. Johnson, of Baltimore, a machinist, in whose shop the Cooper engine had been put into working order. James Millholland was an apprentice in the Johnson shop.

The engine had four wheels, one pair being drivers, placed under the firebox. There were two vertical cylinders set at each side of the footboard, transmitting the power to the driv-

ing wheels through walking beams placed on top of the firebox. The boiler was horizontal, with twin fire boxes.

### The York.

Next engine to appear was the "York," Fig. 37, built by Davis & Gartner, after designs worked out by Phineas Davis. It was a four-wheel engine with upright boiler. The upright cylinders were attached to the boiler and transmitted power to the driving wheels through connections with the side rods. This did not work well, as, of course, the up-and-down movement of the springs changed the length of the piston stroke. The engine took the first prize, however, and was afterwards altered, so that it worked fairly well. The valves were actuated by

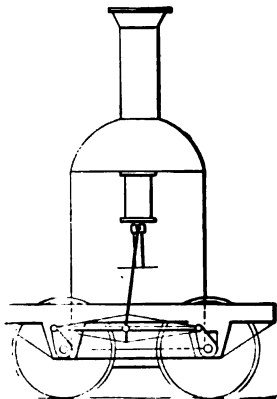

Fig. 37. York

arms, two for each cylinder. The engine in working order weighed about 8,000 pounds.

### The Costell.

The third locomotive, the "Costell," was built in Philadelphia by a watchmaker named Stacey Costell. It had a horizontal Galloway boiler. The actuating machinery consisted of two oscillating cylinders placed on the frame under the boiler. The pistons had rods extending through both heads with one end coupled direct to a crank arm on a short cross shaft. From this shaft the motion was imparted to the driving axle through gear wheels. The valve gear was peculiar and consisted of four way cocks, improvements on Leupold's arrangement, that ad-

mitted and exhausted the steam while also acting as a reversing gear.

### Childs' Rotary Locomotive.

Another watchmaker, of Philadelphia, designed and built the fourth engine. This was Ezekiel Childs, an inventive genius of most original conceptions. He brought out a four-wheel coupled engine with a vertical tubular boiler. But the decidedly original part of the engine was that it was actuated from one rotary cylinder. Steam was admitted to the cylinder through its central shaft and exhausted through the opposite end. It was not a success as a locomotive, but it was a very ingenious arrangement of mechanism.

### The James Engine.

The fifth locomotive was built by William T. James, of New York. It was a four-wheel engine with vertical boiler and a pair of vertical cylinders transmitting the power to a supplementary crank axle (Fig. 60, page 111). The most notable thing about this engine was that it had two eccentrics for each cylinder connecting with a curved reversing link.

None of the engines was considered quite satisfactory, but, as already mentioned, the preference was given to the Davis & Gartner production, the "York," with the arrangement that it should be changed to meet the views of Ross Winans, the company's assistant master of machinery. Under his hand the engine was improved so that it worked satisfactorily.

The Childs engine was accepted for yard service, and James was invited to improve his engine in certain details, which was never done for the boiler exploded destroying the whole apparatus.

### Improved Grasshopper Type.

Experience with the "York" led to the building of the "Atlantic," Fig. 38, which became for a time the standard form of engine on the Baltimore & Ohio Railroad. The engine was designed by Phineas Davis, aided by Ross Winans, then assistant engineer of machinery of the Baltimore & Ohio Railroad. The Atlantic, the first of the grasshopper type, had a vertical boiler with a fan driven by the exhaust steam for stimulating the fire. The cylinders were vertical, 10x12 inches, and they transmitted the power to a supplementary driving shaft by means of spur and pinion, which was geared up to make the wheels revolve

twice for every turn of the crank. By this means wheels three feet in diameter were made equivalent to driving wheels six feet in diameter.

About twenty engines of the "Atlantic" type were built, and they worked very successfully in developing railroad traffic, and only went out of favor when engines with a longer wheel base became necessary. Some "Grasshoppers" were used about Mount Clare shops till about 1890. These engines filled a gap in railroad operating, but they exerted little influence on locomotive development more than warning designers against upright cylinders and upright boilers. They were, however, an excellent object lesson in difficulties that could be overcome by intelligence and perseverance.

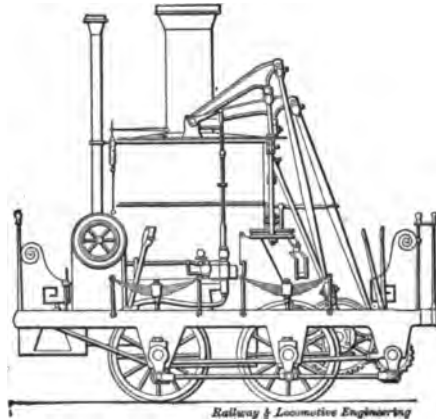

Fig. 38. B. & O. Atlantic, Phineas Davis, Ross Winans

The United States was, in 1830, almost purely an agricultural country, yet, with few mechanics skilled in the working of metals, and very meager workshop facilities, the people began the work of locomotive building in a spirit that guaranteed success.

#### Popularity of Vertical Boilers.

The pioneer railroad engineers and inventors of locomotives in the United States worked out for themselves what they considered the best form of boiler, but much unproductive labor was expended before the fittest was developed. Vertical boilers were in highest repute among American designers evidently owing to the success of Cooper's small locomotive, but some

very expensive blunders were made before inventors settled down to the use of tubes in horizontal boilers for transmitting the heat from the fire to the water.

### The "Cheese" Boiler.

The engine built at York, Pa., by Davis & Gartner had a boiler of the form shown in Fig. 39. In this boiler a circular water-table was used for increasing the heating surface, but it did not work well. The water-table was known among railroad men as "the cheese." It filled up quickly with mud and scale and soon burned out, and was replaced by a boiler of the

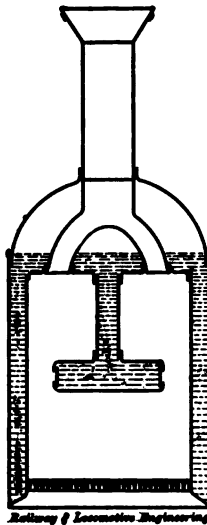

Fig. 39. Cheese Boiler

form shown in Fig. 40. This is a tubular boiler with a combustion chamber, and was a great improvement over the cheese boiler as a steam generator. Still a greater improvement was effected in the boiler (Fig. 41) designed for the "Atlantic." That was a more powerful engine than any of those previously tried and it weighed  $6\frac{1}{2}$  long tons, or 14,560 pounds. The cylinders were 10x20 inches and the driving wheels were 30 inches diameter. The steam pressure carried was generally 50 pounds above the atmosphere.

### Cost of Operating.

In 1832 Jonathan Knight, the chief engineer of the Baltimore & Ohio Railroad, reported that the engine hauled a gross load of 50 long tons from Baltimore to Parr's Ridge, a distance of 50 miles, up an average grade of 37 feet to the mile, at a speed ranging from 12 to 15 miles an hour. The daily expense of the round trip of 80 miles was \$16, which included one ton of anthracite coal at \$8 a ton; engineer, fireman and laborer, \$3.50; oil and packing, 50 cents; estimated wear and tear and interest on cost, \$3.00; water station expenses, \$1. The engine did the

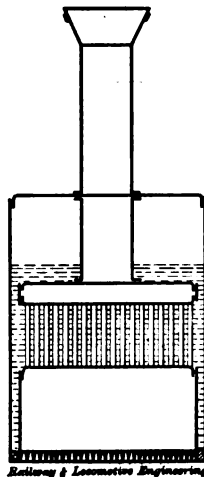

Fig. 40. Improvement on the Cheese Boiler

work of 42 horses, the daily expense of which was estimated at \$33. The first cost of the engine is not given, but it was about \$4,500.

These figures are interesting as indicating the prevailing rate of wages at the beginning of the railway era, and also the price of anthracite coal.

### First Railroad Machine Shops.

The first two engines for the Baltimore & Ohio were built in the machine shop of Davis & Gartner, at York, Pa., because the railroad company did not have facilities of their own for building locomotives. The shops at Mount Clare were, however, ready in 1833, and after that all the engines for the com-



pany were built there, although the shops were under the charge of Phineas Davis, who proved himself to be a first-class mechanic and engine designer. At the same time George Gillingham was superintendent of machinery and the ingenious Ross Winans was his assistant.

Mr. Davis came to an untimely end. The following extract from the minutes of the Board of Directors of the Baltimore & Ohio Railroad Company gives the sad particulars:

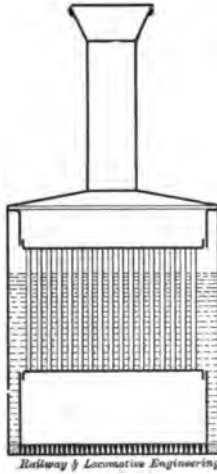

Fig. 41. "Atlantic" Boiler

### Phineas Davis, the First Railroad Martyr.

"When adverting to what has been accomplished in the improvement of the locomotives of the company, it would ill become the board to omit paying a tribute of merited respect to the memory of Phineas Davis, the lamented individual who so largely contributed to the results here indicated. On September 27 (1833) last he, having completed a new engine, availed himself of the occasion of trying it to take his numerous workmen on a visit to Washington. On his return the engine, striking the end of a rail, which the breaking of the iron chair had permitted to get out of alignment, was thrown off the track, and, being on the tender, he was dashed forward against the engine and instantly killed. No other person was injured.

"Phineas Davis was the first who constructed an engine capable of being used on the road in which anthracite fuel was suc-

cessfully employed. With untiring patience he bore disappointment after disappointment, and the eminent and splendid results which ultimately rewarded his efforts are ample testimonials of his genius, and will identify his name most honorably with that great system of internal improvement which is yet to work so many and important changes in the relations of society. Of a quiet and clear perception in matters relating to his profession, he possessed a calm, discriminating judgment. The warmth and energy of inventive talent were tempered by a prudent foresight and great practical skill. He seldom, therefore, took a step which was not a secure one, and the success of his suggestions when put into practice gave them from the

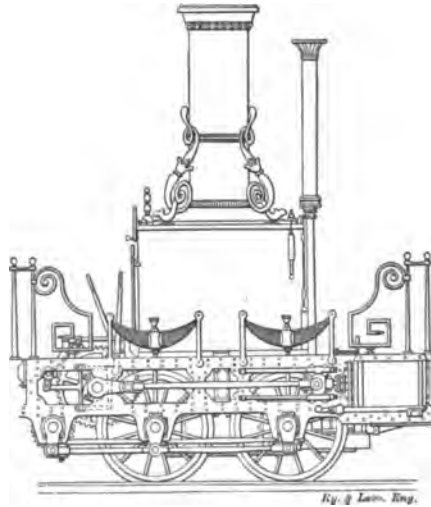

Fig. 42. Crab

first almost the same weight as if they had been the dicta of experience. His private worth and unassuming manners were not less remarkable than his rare abilities. The board deeply regret his loss, and hold his memory in sincere and respectful consideration."

#### Objections to Vertical Boiler and Cylinders.

After the death of Davis the company's shops were leased to George Gillingham and Ross Winans, and they built new grasshopper engines and repaired all the rolling stock under a contract. Between 1831 and 1837 about 20 grasshopper engines

were built, one or two of them for foreign railroads. By degrees the inherent weakness of that style of locomotive began to assert itself. The vertical cylinders tended to impart a bobbing motion and the vertical boiler made the engine top heavy, a defect which was aggravated by the short wheel base.

### **Crab Engines.**

The first deviation from the accepted form of the grasshopper engine was to apply the cylinders in a horizontal position while retaining the boiler upright. The engines of this type, Fig. 42, were built and the workmen called them crabs, because they seemed to run backward. This name became historical.

Placing the cylinders horizontally helped to overcome some of the defects of the engines, but they were never adapted to the high speed that other kinds of locomotives attained during the first decade of the railroad era. On the Baltimore & Ohio Railroad the capacity for hauling freight was of more importance than speed, and we find the improvements effected by Winans on the locomotive were generally intended to increase the tractive power.

### **Merits of the Grasshopper Engine.**

Benjamin R. Lathrobe, who was for many years chief engineer of the Baltimore & Ohio Railroad, wrote about the grasshopper engine:

"The engine was constructed with special reference to the weak track and strong curves of the Baltimore & Ohio Railroad. It was made, therefore, of moderate weight and short coupled, so as to press lightly on the track and round the curves easily, and that it must have done this last is proved by its being able to work itself through the quadrant of 60 feet radius at the street corners. It was supported upon wheels of small diameter with the same views and to keep down the center of gravity, and also to give tractive power with a cylinder of moderate size and pressure of steam, such as was used at that time. The upright boiler was adopted in view of the advantages already enumerated, and of its successful use in the little engine of Mr. Cooper, which seemed to give the maximum of steam generating capacity in the smallest compass, and hence to be especially favorable to the compactness required in so short an engine.

The boiler, affording readiest and staunchest support to the cylinders, was naturally resorted to for that purpose. This gave them their vertical position, and involved the lever beam and long connecting rods or grasshopper-legs. The separate shaft was an accompaniment of the system of gearing required by the small wheels, and relieved of its objections."

### Winans' Work on the Locomotive.

Winans led the world in advocating powerful locomotives and appeared to have the clear conception of the economy that



Ross Winans

would result from the use of engines as large as the track would carry. It is only within the last decade that railroad managers have indorsed by practice the wisdom of Winans' policy. The light track which his engines had to run upon kept down the weight, but with all the restrictions imposed by weak structures and prejudice against heavy loads, he built engines that compared fairly in efficiency with those of modern construction.

The "crabs" were followed by eight-wheel engines, which the trainmen promptly denominated "Mud Diggers." They had horizontal cylinders like the "crabs," and the upright boiler was still retained. The engines would run steadier than the four-

wheelers, but they were very unpopular, although they made good power for hauling heavy trains. They were practically double truck locomotives, a style of construction which Winans originated in a car which he built in 1830.

The Baltimore & Ohio Railroad Company were for years the chief users of unusually powerful locomotives. A reliable record of their work in developing heavy engines has been prepared by one who was for years an honored official of the company, therefore I gladly incorporate in my book the following part prepared by Mr. J. Snowden Bell, who contributed the article to *Railway and Locomotive Engineering*:

### **The Development of the Eight-Wheel Connected Engine on the Baltimore & Ohio Railroad.**

The necessity, under the conditions of its service, of obtaining increased tractive force by increasing the weight of locomotive engines and distributing it over a greater number of driving wheels, was recognized at an early date in the history of the Baltimore & Ohio Railroad, and except as to a single and unsuccessfully experimental instance, that of three locomotives built for the Western Railroad of Massachusetts, from the designs of Ross Winans, it is probable that engines having eight connected driving wheels were first built for and operated on the Baltimore & Ohio. The first of these engines which were used on that road was built by Ross Winans and was placed on the road in 1844, and the first of the type (except the experimental engines referred to) which were built by M. W. Baldwin, were a lot of seventeen, constructed by him for the Philadelphia & Reading Railroad in 1846. It is not likely that an engine of this type was produced by any other of the few less prominent locomotive builders of that period.

The eight-wheel connected engines first placed on the Baltimore & Ohio Railroad were of the class designed and built by Ross Winans and familiarly known as "Mud Diggers," Fig. 43. As shown by the report of the machinery department of the road for 1859, there were then in service, six of these engines, the "Buffalo" No. 35, "Baltimore" No. 36, "Cumberland" No. 37, "Elk" No. 41, "Tuscarora" No. 45 and "Allegheny" No. 46. The writer believes that original Nos. 33 and 34, "Hercules" and "Gladiator," were also "mud diggers." No drawings of these engines are now extant, but their construction will be

readily understood from the accompanying illustration, which is a reduced reproduction of a photograph of No. 37, taken at Mount Clare shops in 1863.

The cylinders were 17 inches in diameter and 24 stroke, and the main connecting rods were coupled to cranks on a shaft extending across the frames in the rear of the firebox and geared by spur wheels to the back driving axle. The driving wheels were 33 inches in diameter and the driving axles carried end cranks which were coupled by side rods. As the main and side rods moved in opposite directions, by reason of the

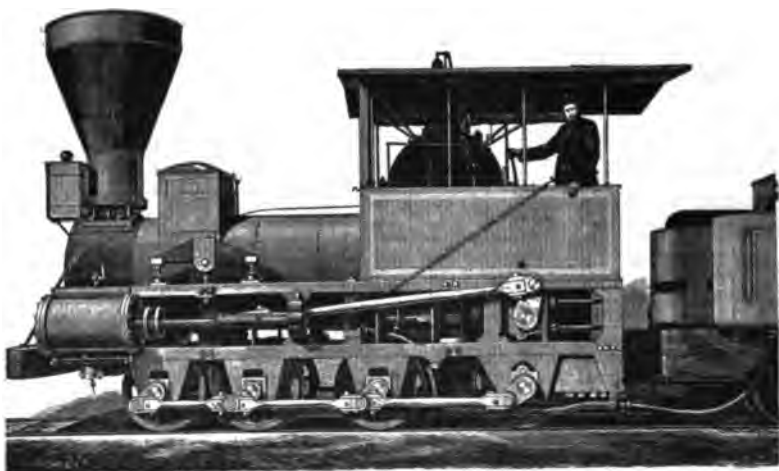

Fig. 43

interposed gearing, the engines presented an odd appearance when running.

The "mud diggers" were built at different dates, from October, 1844, to December, 1846, and some of them were in yard service as late as 1865 and possibly afterward. A number of their cylinders and main connections were used as stationary engines in the shops of the road after their road service was terminated.

The class of engines of the type under consideration which next followed the "mud digger" was that built by M. W. Baldwin, having inclined cylinders, independent cut-off valves, and what was known as the Baldwin "flexible beam truck," carrying the bearings of the front and second driving axles. The first of these, the "Dragon," No. 51, was placed on the road in

January, 1848. This engine had cylinders  $14\frac{1}{2} \times 18$  inches, driving wheels 43 inches, 108 tubes in boiler, and weighed 41,000 pounds. It was equipped with a six-wheel tender having a water capacity of 1,200 gallons.

Four more engines of this type, but larger and of modified form, were built by M. W. Baldwin, as the result of an advertisement for proposals which was published by the Baltimore & Ohio Railroad Co. in the American Railroad Journal, of October 23, 1847. As indicative of the supposed requirements of a heavy freight locomotive of that day, this advertisement may be found of interest, and is as follows:

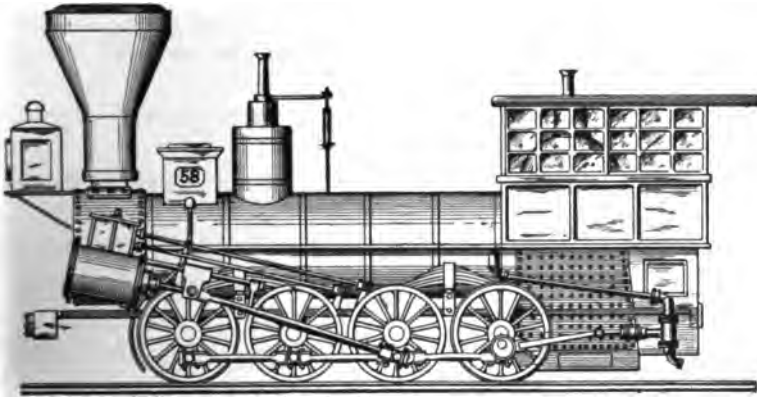

Fig. 44. The Dragon Class

**"To Locomotive Engine Builders:**

Proposals under seal will be received by the undersigned up to Saturday, the 6th of November, inclusive, for furnishing the Baltimore & Ohio Railroad Co. with four locomotive engines, in conformity with the following specification:

1. The weight not to exceed 20 tons, of 2,240 pounds, and to come as near to that limit as possible.
2. The weight to be uniformly distributed upon all the wheels, when the engine is drawing her heaviest load.
3. The number of wheels to be eight.
4. The diameter of the wheels to be 43 inches.
5. The four intermediate wheels to be without flanges.
6. The boiler to contain not less than 1,000 square feet of fire surface, of which there shall be not less than one-fifteenth in the firebox.

7. The tubes of No. 11 flue iron, with not less than  $\frac{3}{4}$  of an inch space between them in the tube sheets.
8. The firebox, with the exception of the tube and crown sheets, to be  $\frac{3}{8}$  inch copper.
9. The tube sheets to be  $\frac{3}{8}$  inch thick.
10. The boiler to be of No. 3 iron, of the best quality.
11. The firebox to be not less than 24 inches deep below the cylindrical part of the boiler.
12. The steam to be taken to the cylinder from a separate dome on the fore part of the boiler.
13. The frame, including the pedestals, to be entirely of wrought iron, and the boiler to be connected therewith, so as to allow of contraction and expansion without strain on either.
14. The cylinders to be 22 inches stroke and not less than 17 inches diameter.
15. The cutoff to be effected by a double valve, worked by separate eccentrics.
16. The angle of the cylinder to be not greater than  $13\frac{1}{2}$  degrees with the horizontal line.
17. The frame and bearings to be inside the wheels and the direction from the cylinder direct with the back pair of intermediate wheels.
18. The centers of the extreme wheels to be not more than  $11\frac{1}{2}$  feet apart.
19. The wheels to be of cast iron with chilled tire.
20. The means to be provided of varying the power of the exhaust in the blast pipe.
21. The engine to be warranted to do full work with Cumberland or other bituminous coal, in a raw state, as the fuel—and the furnace to be provided with an upper and lower fire door with that view.
22. The smokestack to be provided with a wire gauze covering.
23. Two safety valves to be placed upon the boiler, each containing not less than 5 square inches of surface and one to be out of the reach of the engine man.
24. The tender to be upon 8 wheels and constructed upon such plan as shall be furnished by the company, and to carry not less than 3 cords of wood or its equivalent in coal, and 1,500 gallons of water.
25. The materials and workmanship to be of the best quality, and the engine to be subjected to a trial of 30 days' steady



work with freight upon the road, before acceptance by the company.

Payment to be made in cash on the acceptance of the engine. The four engines to be delivered at the company's Mount Clare depot, in Baltimore—the first on the 1st of February, 1848, and the three others on the 1st of March, April and May ensuing.

The track is 4 feet 8½ inch gauge, and the shortest curve of the road is 400 feet radius.

The company to be secured against all patent claims.

Further information will be communicated upon application to the undersigned, at the company's office, No. 23 Han-

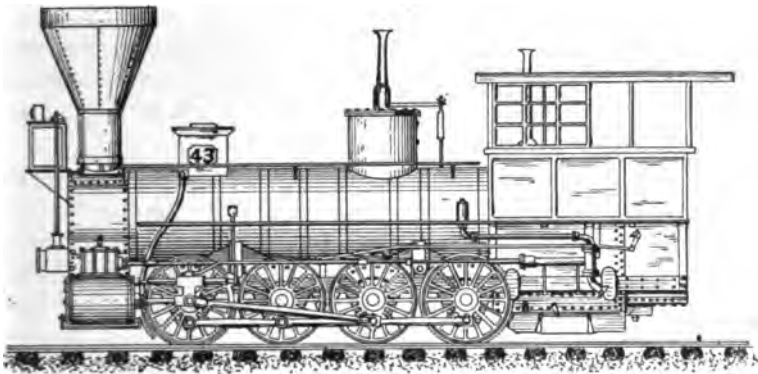

Fig. 45. Baltimore & Ohio Eight Wheel

over street, Baltimore, to which the proposals suitably indorsed will be addressed.

By order of the President and Directors.

BENJ. H. LATROBE,

Chief Engineer and General Superintendent.

Baltimore, Sept. 18, 1847."

The contract for the engines called for by the above advertisement was awarded to M. W. Baldwin, and the four engines built under it were the "Memnon," No. 57, October, 1848; "Hector," No. 58, and "Cossack," No. 60, December, 1848, and "Tartar," No. 62, January, 1849. The illustration of No. 58, which is here presented, Fig. 44, was prepared from the recollection of the writer, in connection with old sketches and others made from Engine No. 57, which is now in the Field Museum, Chicago, but has been altered in several particulars.

The records are meager as to these engines, but their cyl-

inders are known to have been 17x22 inches, and their driving wheels 43 inches, as specified in the advertisement. Their weight exceeded that specified, being at first about 52,000 pounds, and was reduced by change to about 47,000 pounds. All the driving boxes were in pedestals in the main frame, the Baldwin flexible beam truck not being used. The second and third pairs of wheels were not flanged, and the axles were closely set to conform to the required limitation of wheel base. The firebox was of rectangular section, and the back wall was rearwardly inclined from top to bottom, so as to provide a larger grate, and had upper and lower fire doors. As early at least as 1858, these engines had half-stroke pumps worked from the crank pins of the rear axle, as shown in the illustration, but they may have been built with crosshead pumps. One of the engines was used in hauling freight cars between Camden Station and Bolton, in Baltimore, and did good work on the heavy grade in Howard street.

The engines "Saturn," No. 56, built by the New Castle Manufacturing Company, in June, 1848, and Nos. 54, 63 and 64, built by the company in 1848, 1849 and 1850, were of the same general construction as those last referred to, and after these, no more of this class were built for the Baltimore & Ohio Railroad.

The next class of eight-wheel connected engines which was introduced on the road was known as the "Company's eight-wheel engine," and is shown, Fig. 45, in the accompanying reproduction of an old hand sketch of No. 43, made by the writer. They were Nos. 33, 34, 38, 40, 43, 49, 67, 72, 76, 83 and 131, and were built at different dates from October, 1850, to November, 1853. Nos. 67, 72 and 83 had cylinders 20x22, and the others 19x22; the driving wheels of all of them were 43 inches. A report of their performance will be found in Colburn's Locomotive Engineering, page 83, which gives the following particulars of the engines: Weight, 57,400 pounds; firebox heating surface, 87.5 square feet; tube heating surface, 984 square feet; total heating surface, 1,071.5 square feet; number of tubes, 134; diameter, 2 inches; length, 14 feet.

These were the first direct connected engines of the type in which the cylinders were set horizontally, and they were bolted to a flat-sided smoke box, the bed plate or saddle not being then known. The valves were worked by drop-hook gear, which required connections, as shown, for starting bars.

The next, and up to 1874, the most extended application to service of the eight-wheel connected engine, was that of the camel engines of Ross Winans. These have been so frequently and fully described and illustrated in technical publications that it will suffice here to merely note that there were three classes of them, the "short," "medium" and "long" furnace camels, all having cylinders 19x22, and 43-inch driving wheels, and not varying to any extent, except as to the shape and size of firebox.

The first of this class, the "Camel," No. 55, was placed on the road in June, 1848, and corresponded in all essential partic-

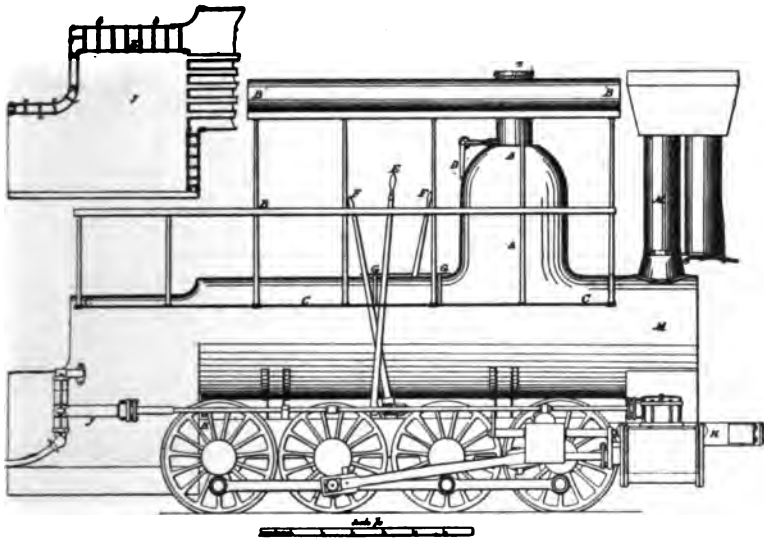

Fig. 46. First Camels

ulars with the accompanying illustration, Fig. 46. The cylinders of this engine were 17x22, and the writer believes that it was the only camel of the "short" furnace type, and the only one having cylinders smaller than 19 inches, which the road ever had.

Up to 1863, one hundred and twenty camel engines had been put in service on the Baltimore & Ohio Railroad, and the last one, No. 219, was built in February, 1857, soon after which a controversy arose between Ross Winans and Henry Tyson, then master of machinery, as to the relative merits of the camel and the six-coupled ten-wheel engine, the result of which appears

to have been a cessation of orders for engines of the former class by the company. In 1863, the company being pressed for additional motive power, bought, at a high figure, three long furnace camels which had been in Winans' shop since 1860, one of which, No. 199, is here shown, Fig. 47, and no more of this class were thereafter built.

In 1865, Thatcher Perkins, then master of machinery of the company, designed a new class of eight-wheel connected engine, in which he discarded those features of the camel engines which had been shown in service to be objectionable, and retained their useful ones in modernized and improved form. Twenty-

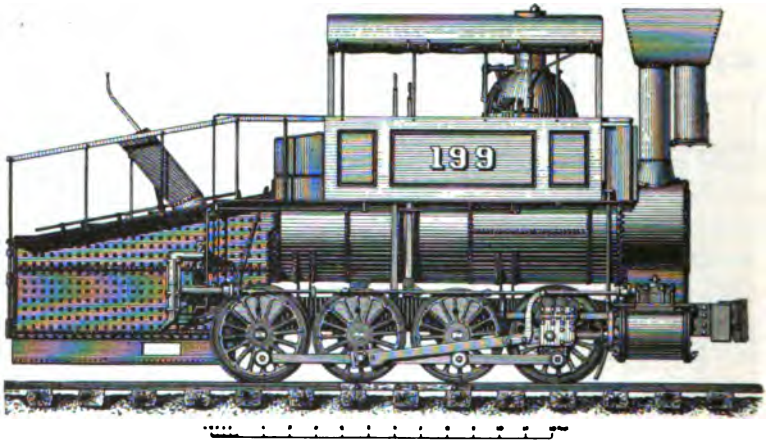

Fig. 47. Last of the Camels

seven of these engines were placed on the road, and the first one, No. 32, Fig. 48, was built at Mount Clare shops in 1865. Of the others of the lot, 20 were built by the Grant Locomotive Works, Paterson, N. J.; 2 by Reaney, Son & Archbold, Chester, Pa., and 4 by the company. They were generally known as "greenbacks," as the Grant engine were painted that color and looked very well in it. The illustration is a reduced reproduction of a drawing made carefully to scale in all details, by the writer.

Among the improved features of the Perkins engines as compared with the camels, may be noted their larger and more strongly constructed boilers, the use of heavy and substantial bar frames instead of plate frames, round smoke boxes, with a

saddle or bed plate connection to the frames and cylinders, draw bars connected directly to the frames, and stationary link valve motions.

The general dimensions of these engines were as follows:

Weight of engine (empty), 65,000 pounds; weight of tender, 23,000 pounds; steam pressure, 100 to 110 pounds.

Cylinders,  $19\frac{1}{2} \times 22$  inches; driving wheels, 43 inches.

Boiler diameter,  $48\frac{3}{4}$  inches; boiler thickness,  $\frac{3}{8}$  inch.

Flues, number, 115; diameter outside (No. 12 W. G.),  $2\frac{1}{2}$  inches; length, 15 feet; flue sheet (copper),  $\frac{5}{8}$  inch.

Firebox, length, 66 inches; width, 42 inches; depth, 57 inches; grate area, 19.25 square feet.



Fig. 48. Perkins Eight-Wheel Engine

Back sheet (copper),  $\frac{3}{8}$  inch; side sheets (for  $36\frac{1}{2}$  inches from bottom, copper),  $\frac{3}{8}$  inch.

Exhaust nozzle,  $4\frac{1}{2}$  inches; tender water capacity, 2,140 gallons.

The Perkins engines were the last class of eight-wheel connected engines, without leading trucks, which were used on the Baltimore & Ohio Railroad, and the consolidation or 2-8-0 type was adopted as the standard for heavy freight service about 1874, when a number of these engines were built for the road by the Danforth Locomotive & Machine Co., as well as by the Baltimore & Ohio Railroad Co. in its Mount Clare shops. These engines were among the heaviest of those constructed at that

period, weighing 96,550 pounds, and had cylinder of the then usual dimensions of 20x24 inches and 50-inch driving wheels. The engines of this type, which were from time to time subsequently obtained by the road, accorded with the general increase which was made in weight and dimensions, and include a number of compounds of different constructions.

Since the above was written by Mr. Bell, important changes have been effected on the heavy motive power of the Baltimore & Ohio Railroad, and I now show the present type.



Fig. 49. Latest B. & O. Eight-Wheel Connected Engine

#### Latest B. & O. 2-8-0.

The latest standard eight-wheel connected engines shown in Fig. 49, designed by J. E. Muhlfeld, have cylinders 22x30 inches, and driving wheels of 60 inches diameter, and, with a steam pressure of 200 pounds per square inch, the calculated tractive effort is about 41,100 pounds.

The valves of this engine are the ordinary slide, of the Richardson balanced type. They have a travel of 6 inches and a steam lap of  $1\frac{1}{4}$  inches; the exhaust lap is  $\frac{1}{8}$  of an inch. The valves are set with  $\frac{1}{16}$  inch lead in full gear, back and forward, and the motion is indirect. The eccentrics are on the main driving axle, and the link is placed forward of the rocker and has a transmission bar by which the motion of the link

block is carried back to the rocker. Brass eccentric straps have been used, and cast steel driving boxes work in brass shoes and wedges. The wheel base of the engine itself is 25 feet 7 inches, with a rigid wheel base of 16 feet 8 inches. The wheel base of the engine and tender is 59 feet  $8\frac{1}{4}$  inches. The weight of the machine in working order is 208,500 pounds and the amount carried on the drivers is about 185,900 pounds. Engine and tender together weigh 345,900 pounds. The springs of the two leading drivers are overhung and the main driving wheels are without flanges. The arrangement of piston rods and guides is such that metal packing may be applied when the crank pins are on the forward center. Piston rings can be applied without disconnecting the piston rod from the crosshead.

The boiler is of simple design and substantial construction, with  $56\frac{1}{2}$  square feet of grate area, all in one plane. The tubes are 282 in number and are of  $2\frac{1}{4}$  inches diameter. They are each 15 feet 10 inches long, and, combined, give a heating surface of 2,612.8 square feet. The firebox is  $108\frac{1}{8}$  inches long and  $74\frac{1}{4}$  inches wide, with  $4\frac{1}{2}$  inches water spaces on all sides. The firebox gives 162.26 square feet of heating surface, and when added to that given by the tubes the total amounts to 2,775.6 square feet. The front ring of the boiler is  $74\frac{7}{16}$  inches outside diameter, and, as the design of the boiler is a straight top, the smokestack has been made quite short, and the dome and sandbox have been flattened to keep within the B. & O. clearance dimensions.

# First Links of the Pennsylvania Railroad

## CHAPTER VI.

### The Camden & Amboy Railroad.

The Camden & Amboy Railroad and Transportation Company was incorporated by special charter in February, 1830; and the company was authorized to survey, lay out and construct a railroad from the Delaware River to Raritan Bay,



Robert L. Stevens

with as many tracks as might be deemed necessary, provided the width of roadway did not exceed 100 feet. A lateral road from the main line to Bordentown was also authorized. The road was to be commenced within two years and completed within nine years, otherwise the charter would be null and void.

This was not the first projected link of what is now the Pennsylvania Railroad, but it was the first part put in operation.

Considerable opposition to this railroad was made at first



by the canal interests; but they finally formed a combination and the construction of the railroad proceeded without interruption. A portion of the road near Bordentown was opened late in 1831 with becoming ceremonies, this having been the first railroad opened in New Jersey. Among the guests of the railroad company on this occasion, was Madame Murat, wife of Prince Murat, a nephew of the first Napoleon. The members of the legislature came in a body from Trenton in stage-coaches, and thousands of people from far and near assembled to see the "John Bull" pull its first passenger train.

### **New Jersey Had First Railroad Charter Ever Granted.**

The Camden & Amboy Railroad was not the first project of the kind agitated in New Jersey. As early as 1815, the legislature of that State passed an act creating a company "to erect a railroad from the Delaware River near Trenton to the river Raritan near New Brunswick." Commissioners were appointed to raise money by subscription to execute the work; but the enterprise died for want of financial support. Its promoters were ten years in advance of the railroad building sentiment.

The movement is of historical interest, because it was the first company in the world formed to build a railroad for general transportation purposes.

### **Quaker and Aristocratic Bordentown.**

The old town of Bordentown, 28 miles from Philadelphia, was well worthy of being the starting point for the first railroad train to run in New Jersey. Situated on a bend of the Delaware River, which formed the nearest point to water communication with New York, the people of the place had long been noted for their enterprise, in maintaining stage-coach lines to South Amboy, the shipping point for New York. The railroad, which the people of Bordentown did much to promote, was eventually the ruin of the town, for it was left a way station on a branch line. It was originally a quaker settlement, yet one of the most cherished glories of the place was that it was for years the residence of Joseph Bonaparte, brother of Napoleon.

### **Camden & Amboy's Celebrated Pioneers.**

The Camden & Amboy Railroad Company exercised a powerful influence on the development of the locomotive engine;

but the work was due principally to the ability of two men, Robert L. Stevens and Isaac Dripps. Mr. Stevens was president of the company and Mr. Dripps was a young machinist and marine engineer whom Mr. Stevens engaged to take charge of the machinery of the railroad.

Robert L. Stevens was a son of Col. John Stevens, whose wonderful foresight into the future of land transportation by means of the steam engine has been repeatedly referred to. The son was as progressive and enterprising as the father, and was besides an engineering genius. He effected celebrated improvements on steamships; invented, along with his nephew, the famous Stevens cut-off; first applied anthracite as fuel to steamers; invented the T-rail for railroads, and did many other wonderful things.

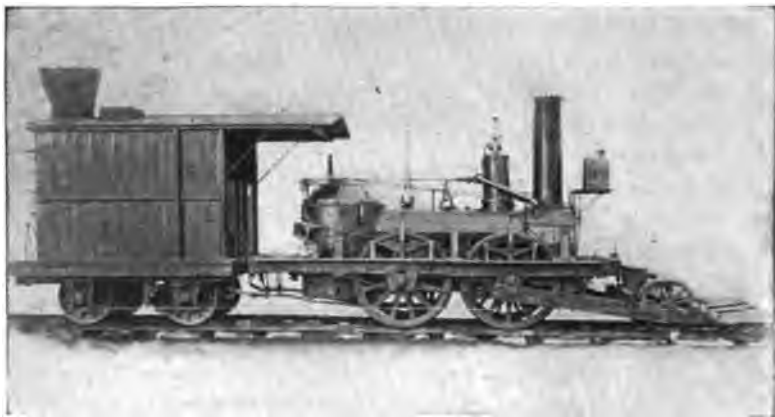

Fig. 50. The John Bull of the Camden & Amboy Railroad

The first work on the new road was done at Bordentown on December 4, 1830. President Stevens advocated an all-iron rail in place of the wooden rail or stone stringer plated with strap iron, then in use on a few short railroads, and a special resolution was passed by the Board of Directors authorizing him to go ahead and purchase a supply, no metal rails being made in this country at that time.

While abroad he examined several English locomotives. He was present at the trial of Stephenson's Planet, and the results were so satisfactory that he at once ordered one for the Camden & Amboy of similar construction. This engine, called the Stevens but changed to the John Bull and No. 1, was completed in May and

shipped by sailing vessel from Newcastle-on-Tyne in June, 1831, arriving in Philadelphia about the middle of August. It was then transferred to a sloop at Chestnut street wharf, whence it was taken to Bordentown.

The John Bull originally weighed 11 tons. The boiler was 13 feet long and 3 feet 6 inches in diameter. The cylinders were 9 inches by 20 inches. There were four driving wheels 4 feet 6 inches in diameter, arranged with outside cranks for connecting parallel rods. Owing to the sharp curves on the road, these rods were never used. The driving wheels were made with cast iron hubs and wooden spokes and felloes. The tires were of wrought iron three-quarters of an inch thick, the tread being 5 inches and the depth of the flange  $1\frac{1}{2}$  inches. The gauge was originally five feet. The boiler was composed of sixty-two flues 7 feet 6 inches long and 2 inches in diameter. The furnace was 3 feet 7 inches long and 3 feet 2 inches high and was for burning wood. The grate surface was 10 feet 8 inches; the firebox surface 36 feet; flue surface 213 feet.

About the time that Robert L. Stevens became president of the Camden & Amboy Railroad, he found Isaac Dripps, while still an apprentice machinist, in charge of the erection of the machinery of one of the largest steamboats that had ever been built, and doing other important marine engineering work. Mr. Stevens recognized in the young engineer the material from which leaders of men and managers of great enterprises are made, and engaged him as master mechanic of the Camden & Amboy Railroad.

### Erection of the John Bull.

The first work which Mr. Dripps did was to put the locomotive, which was originally called the Stevens and which they had christened the "John Bull," Fig. 50, into working order. The engine had been ordered from Robert Stephenson & Co. and was received at Philadelphia in 1831. Mr. Dripps transported it in a sloop up the Delaware River to Bordentown, where he put the parts together. He had never seen a locomotive engine before, but he studied the mechanism carefully and succeeded in erecting it without making a mistake.

### Overcoming Difficulties.

The engine was not provided with a tender, but this did not embarrass Mr. Dripps much. He found a small four-wheel

car that could carry enough wood to last a short trip, and for water tank he purchased a whisky cask from a neighboring grocery. For a hose to connect the tank and engine feed pipe, he called in the services of a shoemaker, who made a leather pipe that answered the purpose. Thus equipped, the engine was ready for the service of hauling the spectacle passenger train.

No obstacles delayed the work of the men who first made the locomotive a success. They worked with "energy divine."

The company had ordered several new engines from England, but Mr. Stevens did not propose to be dependent on



Isaac Dripps

foreign makers for the motive power of the railroad. He opened shops in Hoboken for the construction of locomotives, and Mr. Dripps had general charge of the work.

### The Cow Catcher.

In the first few locomotives he built Mr. Dripps imitated the John Bull in wheel arrangement and in running gear, but the boilers were made without the hemispherical dome. The necessity for a pilot to push obstructions off the track early became apparent, and Mr. Dripps designed and applied to the

engines the two-wheeled pilot or so-called cow catcher, now on the John Bull, as shown in our illustration. This was made to carry some weight off the front driving wheels, and performed in an inferior way the functions of the Jervis swiveling truck.

Cow catchers were peculiar to American railways, and were made necessary through the unprotected condition of the track, which was rarely fenced. In other countries the owners of domestic animals were held responsible for keeping them off the property of a railway company, just as they were held responsible for the trespass of their animals upon any other property; but a different policy was inaugurated with railroad construction in the United States. It became the recognized practice to hold the railroad's responsible for any damage done by trespass of animals upon their right of way, and the cow catcher was introduced to prevent the neighbor's horse, or his ox, or his ass, or his hog, from throwing trains off the track.

The first cow catcher was a heavy cross-bar secured in front of the leading pair of wheels. A master mechanic on the Philadelphia & Reading Railroad used double bars and fortified them with long spikes, like elongated harrow teeth. A stray bull was impaled on this weapon shortly after it was introduced, and the use of a switching rope was necessary to detach the animal. That form of bull catcher was considered entirely too strenuous and was at once ruled out of use, and the germ of the modern pilot soon appeared. The sleigh-like contrivance put on the "John Bull" did not attain any popularity.

The first three locomotives built by Mr. Dripps at Hoboken were taken by him to South Amboy, where they were used to haul material and to perform the part of schools to instruct men in the art of locomotive engine running. The school of experience, was the principal institute of instruction afterwards, but in 1832 a special school locomotive was considered necessary.

### Slow Traveling.

Before railroads were opened, the State of New Jersey seemed to act as a barrier between the two great centers of population, New York with its drainage of business from the whole of New England, and of Philadelphia, which was the entrepot of commerce from a vast region to the South and West.

Although the distance between New York and Philadelphia is only about ninety miles, the journey was a remarkably

tedious one in the beginning of last century. The most expeditious method was to take a boat from New York to South Amboy, then a thirty-five-mile stage ride to Bordentown, thence twenty-eight miles by the Delaware River to Philadelphia. The trip which is now done in two hours was generally performed in two days and that was considered wonderfully fast traveling.

The opening of the Camden & Amboy Railroad greatly stimulated the traffic between New York and Philadelphia, and the railroad company had more than enough to do in trying to provide power and rolling stock to move the growing business. The railroad had not been in operation more than two years, when President Stevens and Superintendent of Machinery

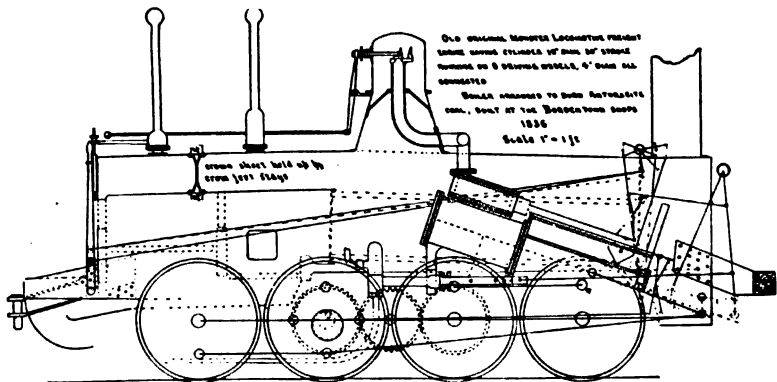

Fig. 51. Original Monster

Dripps began consulting about the desirability of building more powerful locomotives than anything that had previously been thought of.

### The Monster.

The result of consultations was the designing of a class of locomotives known as the "Monsters." The first of these engines was partly built in Hoboken—the boiler in New York, and the parts were assembled in the company's shops at Bordentown in 1836. The original design of the engine copied from shop drawings is illustrated in Fig. 51.

In 1885 Isaac Dripps sent some tracings of drawings to the American Railway Master Mechanics' Association; and in a letter concerning them he says: "Plate No. 1 (Fig. 52) shows a boiler for burning anthracite coal for 18x30-inch cylinder

freight engine, built in New York in 1835 for the Camden & Amboy Railroad Company. The furnace of this boiler, at its front end and some distance back from the tube sheet, had a bridge wall, or water space extending upwards to within 13 inches of the crown sheet. Between the bridge wall and tube sheet was a combustion chamber.

"The boiler as originally constructed was very deficient in steam making, and after being in use some time she blew off the dome, breaking through the cast-iron throttle valve at the bottom of the dome.

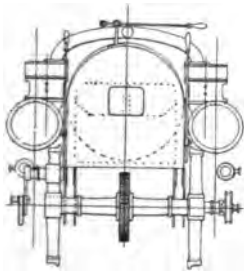

Section Through Rear Axle

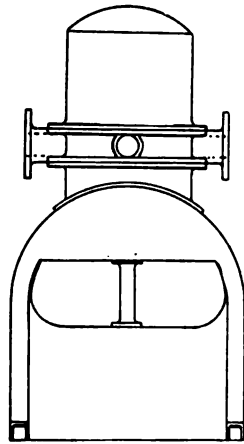

Section Through Fire Box

### Converting a Combustion Chamber into a Fire Box.

"In rebuilding the boiler, I altered the combustion chamber into a small fire box, by cutting away the bottom of the boiler between the tube sheet and the bridge wall, placing the grate bars low down and putting a fire door on the side. The bridge wall, or water space, being so high, that is near the crown sheet, gave me sufficient room to raise the grate bars of the main or back fire box.

"These alterations of the boiler with the use of the exhaust jet box inside of smoke box, and tapered smoke pipe, increased the steaming qualities of the boiler very satisfactorily. This was the first time that the exhaust jet box was ever used." (Changes shown in Fig. 53.)

In the bridge that separates the furnace from the combustion chamber is a flanged pipe extending through the crown

sheet for the purpose of promoting circulation. The crown sheets of fire box and combustion chamber were supported by crow-foot stays, which were found to be perfectly satisfactory.

### Design of Engine.

The engine part of the Monster was very peculiar, the design having no doubt been influenced by Mr. Stevens' and Mr. Dripps' connection with marine engines, which in those days included many curiosities. It was an eight-wheel connected engine, each set of four wheels being free to move in a plane

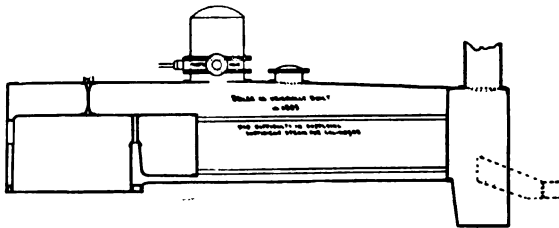

Fig. 52. Original Boiler of Monster

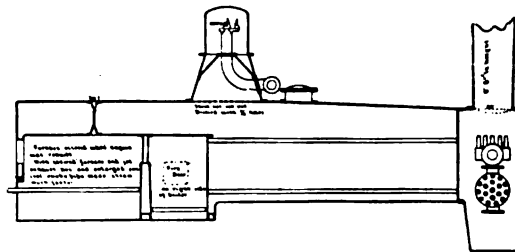

Fig. 53. Rebuilt Boiler of Monster

slightly different from the other set, which gave it some flexibility in passing curves, the idea of which was following Allen's ideas with his double end locomotive for the South Carolina Railroad, and which was afterwards developed by Fairlie, Mason, Mallet and others.

The cylinders, which were 18x30 inches, were set on the side of the boiler at an angle of about 30 degrees, with the piston working towards the front. The cross-head connected with a vibrating beam, which the men called the "horse neck," that moved like a pendulum. A main rod was connected to the pendulum and transmitted power to the third pair of wheels, which were the driving wheels. Between the second and third



pair of wheels was a supplementary shaft carrying a spur wheel, which engaged with gears on the second and third axles, by that means transmitting the power to the forward wheels. Each set of four wheels was provided with connecting rods, the crank pins on the forward set being located on the opposite side of the wheel from the hind set.

The valve motion was driven from a return crank on the main pin, as shown in the rear section. It will be noticed that this return crank carried an eccentric as well as a pin. The eccentric moved one of the drop hooks, the pin the other, being the first time this arrangement was used. There was a riding cut-off valve like other cut-off arrangements common in those

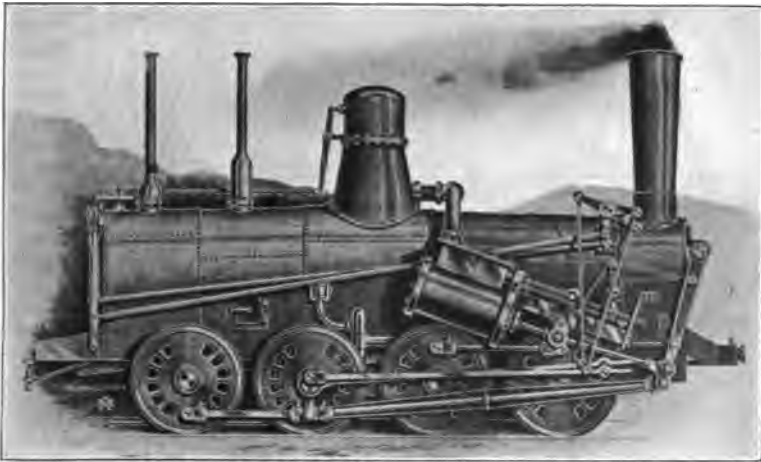

Fig. 54. The Rebuilt Monster

days, and it was driven by connection with the pendulum lever.

Large copper exhaust pipes were used, and each had a feed pipe traversing the inside for the purpose of heating the water.

There was no frame employed, all the attachments having been secured to the boiler. The axle box pedestals were riveted to the boiler. The four back driving boxes had wedges, but the forward boxes had none, the loose fitting box in the pedestal being designed to give some flexibility in rounding curves.

The engraving, Fig. 54, shows the Monster rebuilt into a ten-wheeler and numbered 635 of the Pennsylvania Railroad's list. The engraving was made from an old tintype found by Mr. John A. Hill in 1890, when he was editor of the *Locomotive*

Engineer. Some details of the picture were very obscure, but people who were acquainted with the engine say that the likeness is faithfully brought out. The engine was in use as late as 1875.

The Monster was not a success as a locomotive, but its work was sufficiently satisfactory to bring an order for three others, which were built at the Trenton Locomotive Works. It was away ahead of the requirements of the time, being capable of exerting a draw bar pull of 180 pounds for every pound of effective steam pressure in the cylinders. It was relatively more powerful than any locomotive in use to-day.

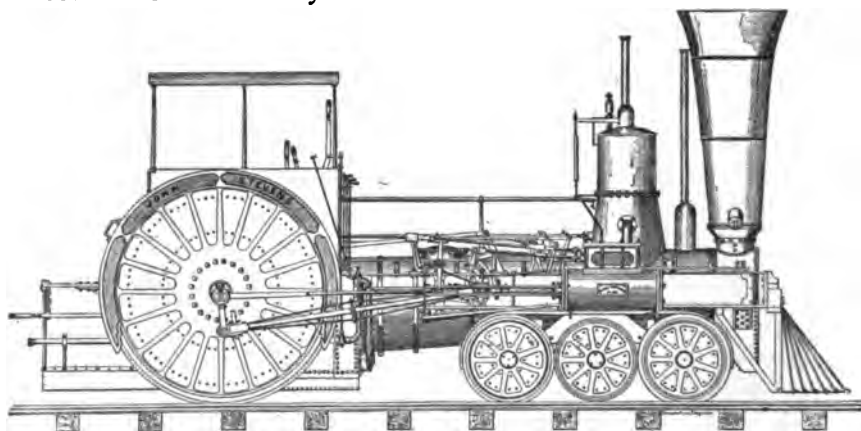

Fig. 55. The Stevens Crampton Locomotive

### The Camden & Amboy Cramptons.

In 1845 President Stevens visited Europe, and saw some Crampton locomotives, which excited his admiration. On returning to the United States he advised Mr. Dripps to design an engine of the same general type with a single pair of driving wheels, 8-feet diameter. The drawings were made and the engine was built by Richard Norris & Sons, of Philadelphia. The engine is illustrated in Figs. 55 and 56.

The order entered in the Norris books for the engine reads:

One passenger locomotive for Camden & Amboy Ry.  
Gauge, 4 feet  $9\frac{1}{8}$  inches.

Boiler 38 inches diameter, made with spiral seams, to burn anthracite coal, the steam dome to be put on cylinder part of boiler, with steam pipes leading to steam chests.

Cylinders 13x34 inches horizontal.

Cut-off. Worked from an eccentric outside of shackle pin.

Guides. Of steel, with block and heads.

Cross-heads. Of wrought iron with cylindrical journals.

Wheels. Two driving wheels 8 feet diameter.

Axles. Axles  $6\frac{3}{4}$ ; truck wheels with tires 36 inches diameter. Axles 4 inches diameter.

Tubes. 98, of iron 2 inches diameter; 12 inches long.

Name, John Stevens; No. 28; tried April 17, 1849.

The engine weighed about 50,000 pounds. Both the driving and truck wheels were made of wrought iron, and the spaces between the spokes filled with wood.

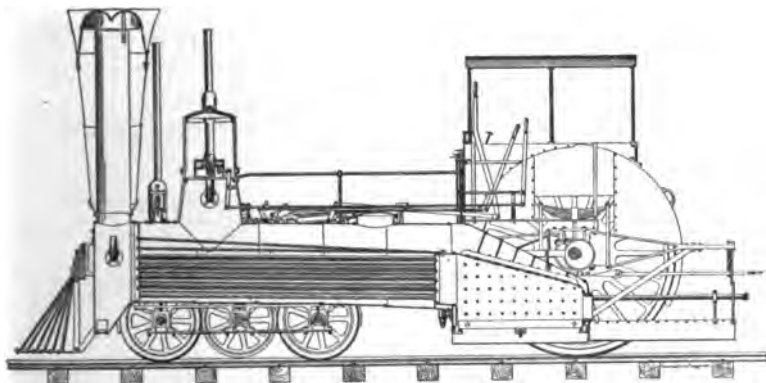

Fig. 56. Section of the Stevens

The boiler shown in Fig. 56 was very small—38 inches diameter—with but 98 flues. In the longitudinal section (Fig. 56) can be seen the plan of staving, the long rods among the flues being then deemed a necessity. The fire box was 5 feet long, no width given, but it could not have been over 48 inches; the crown bars running lengthwise were stayed to outer sheet by bolts, spaced 10 inches apart. The dome was very large, and had a flanged joint near the center of its height; the throttle was of the old slide pattern, encased in a box that was located on top of an arch pipe that went out each side of dome to the chests; there was a dry pipe above the throttle.

The fire door was below and behind the axle, and the fireman stood in a pit, the bottom of which was on a level with bottom of ash pan, the tank deck being about breast high. In the smoke box there was a deflecting plate over the tube

plate, being the first case of a diaphragm being used for spark arresting.

On top of the dome was a safety valve whose lever extended to a spring scale. This was the only means of knowing the pressure carried—as steam gauges were not then in use. Near the stack is shown a safety valve that was encased to prevent the men from meddling with it.

J. W. Sanford, for many years master mechanic of the Pennsylvania shops at the Meadows, Jersey City, fired and ran this engine and others of its class. He says they used to pull six of the old, light cars, but even this train was more than they could handle well. They were not provided with sand boxes, and were slippery and very slow to get a train under way, but, once in motion, with a light train, they would run as fast as men cared to ride. Mr. Sanford recalls the experi-

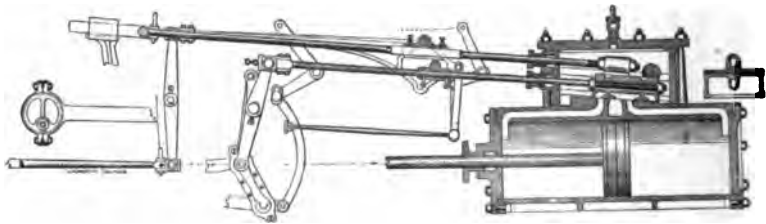

Fig. 57

ments made with different kinds of smokestacks, one of which terminated in an elbow at the top, with a loose joint provided with handles, with which to turn it out of the wind. The one shown had a place to clean it out, and the lower extension of smoke box also had a cinder slide.

The exhaust pipes were carried from the chests along each side of the boiler between the frames, and entered the side of the smoke box about half-way up. This engine and its mate had a stroke of 34 inches, but the rest of the series had 38-inch stroke. The steam ports were only 8 inches long, by 1 3-16 inches wide, the exhaust ports 8 inches by 2 inches. The cylinder cocks were of the old, independent kind—fireman had to run around the engine and close them up after the engine was in motion.

The 6-wheeled truck was pivoted to the boiler so far back that it carried most of the weight, making the engine very deficient in adhesion and prone to get off the track. The center pair of wheels were without flanges. The peculiar plan of arranging the truck

springs is shown in Fig. 57, and seems to have some advantages over modern devices.

To the younger generation, the valve motion (Fig. 57) will seem complicated; the two wheel eccentrics were located inside the wheel and operated the large hooks, shown with the curved lifting rod. These worked the main rocker arm and the main valve, and the reversing was done by changing from one hook to the other by handling one of the levers in the cab. The independent cut-off was a small valve, riding on top of the main valve, and operated by the return crank eccentric on the main pin. This motion was transmitted to the valve through the back rocker.

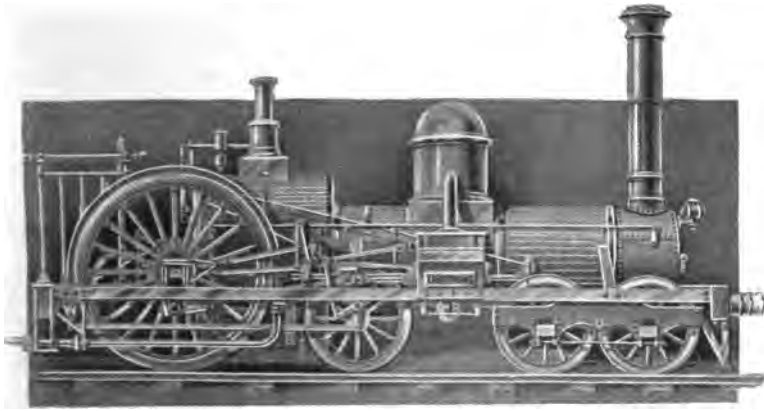

Fig. 58. Lightning, Built by Edward S. Norris at Schenectady Locomotive Works, 1849

In starting, the cut-off lever was moved so as to engage the lower hook. This made the cut-off valve come to the center of the main valve, and, as that always ran full stroke, it would cut its own steam off, the cut-off motion merely sliding the block on the upper rod back and forth, and doing no work.

As soon as the engine was under way the engineer "threw on the cut-off," which disengaged the lower hook from the main valve stem, and engaged the upper one with the cut-off valve, which traveled on top of the main valve, cutting the steam off short, much as a link does when hooked up, except that, as the main valve controlled the exhaust, the latter was carried well to the end of the stroke.

These engines ran from 1849-50 to 1861-2, and one as late as 1865; two of them were cut up and the others were also cut up,

with the exception of the cylinders and guides, these being used on some 8-wheeled engines with 6-foot wheels, that were built at that time.

Neither the Monster nor the Crampton class of engine became the originator of a type in American locomotive practice; but both of them possessed details of mechanism that were adopted by subsequent locomotive builders. They marked a decided step of progress.

### Large Driving Wheel Engines.

The early locomotive designers the world over made a common mistake of imagining that the size of driving wheels, instead of the size of boiler, controlled the speed capacity of a locomotive, and

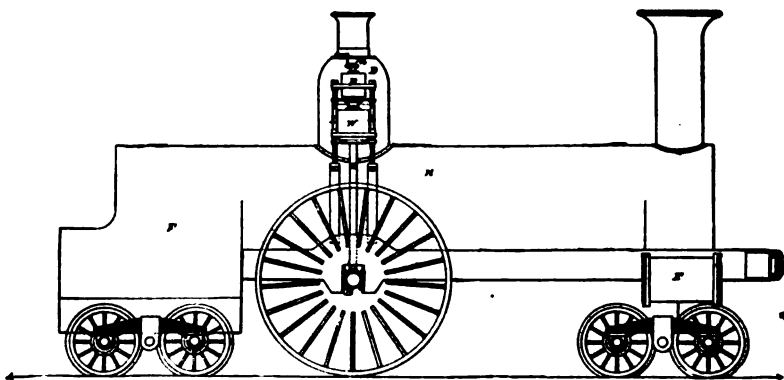

Fig. 59. Carroll of Carrollton, Ross Winans' Idea of High Speed Engine, 1852

American designers did not keep clear of this fallacy. This sentiment was what led to the building of the Stevens' Crampton engine for the Camden & Amboy Railroad with driving wheels 8 feet diameter. A few others noted for the large size of their driving wheels and the small capacity of their boilers were built, and provided object lessons that were not soon forgotten.

The "Stevens" already mentioned was the first engine conspicuous for its great size of driving wheels. In 1849, the year that the Stevens was put to work, Edward S. Norris, of the Schenectady Locomotive Works, built the "Lightning," Fig. 58, for the Utica & Schenectady Railroad, with a single pair of driving wheels 7 feet diameter, cylinder 16x22 inches, boiler 42 inches diameter, with 116 2-inch tubes 10 feet 3 inches long, providing about 670 square feet of heating surface. About one year's service proved the engine to be a failure. The "Mameluke," built by the Amoskeag Company in 1849,

had inside cylinders 15x24 inches and two pairs of coupled driving wheels 7 feet diameter. The "Carroll of Carrollton," Fig 59, made by Ross Winans in 1852, had a single pair of driving wheels 7 feet diameter, and had four wheel trucks in front and rear.

Winans tried to strengthen the weak point of previous single driver engines, viz.: deficiency of adhesion, by providing the "Carroll of Carrollton" with a traction increaser shown in the engraving of the engine, but it did not secure success, for the engine never did any regular work.

The Philadelphia & Reading, also the Hudson River Railroad, each had two locomotives built by the Trenton Locomotive Works, Trenton, N. J., with single pair of driving wheels 7 feet diameter which seemed to be the standard size for that style in those days, but they were soon altered. When the short lived movement in favor of big driving wheels died out, the locomotive designers went gradually back to driving wheels about 5 feet diameter, which was the popular size for many years and was quite large enough for the prevailing speed of trains. Locomotives with driving wheels 7 feet diameter or over are quite common to-day, but they have cylinder power sufficient to drive them with boilers of sufficient capacity to provide all the steam required. As late as 1864 the average speed of express trains in the United States was 32 miles an hour for a few of the most important lines, and 26 miles an hour on others with long mileage. Large driving wheels were not necessary for these speeds, but experience was necessary to prove the fittest.

### Purpose of the Camden & Amboy Railroad.

When it was built the Camden & Amboy Railroad, 61 miles long, formed the principal artery of traffic between the most important cities of the Union, New York and Philadelphia. The question has often been asked, Why did they not build the line between Philadelphia and Jersey City, as New York and Philadelphia are now connected by several railroads? The early railroad builders were influenced by several considerations. Camden is across the Delaware river from Philadelphia and was easily reached by water. Amboy is on the Raritan Bay, which is part of New York lower bay, and made a convenient landing place to reach New York by a short water passage. By building only between Camden and Amboy, the fathers of the enterprise avoided bridging any great rivers and had a fairly level country to traverse.

The charter granted to the Camden & Amboy Railroad Com.

pany by the State of New Jersey, showed a keen discrimination to conserve the public interests while encouraging the enterprise that was to confer great benefits upon the community. The road was to be commenced within two years and completed within nine years from passage of the act, otherwise the charter would be null and void. A right was reserved to the State to enter in and occupy the property at the expiration of thirty years by paying therefor the value as appraised by special commissioners appointed equally by the State and the railroad company.

In 1832 the New Jersey Railroad & Transportation Company was formed and incorporated by special charter. It took in three companies, the Camden & Amboy, the New Jersey Railroad & Transportation Company and the Delaware & Raritan Canal Company, which were managed by a joint board of directors. Under this management the joint companies prospered and gave satisfactory service to the public at low cost, and it continues to perform the same functions to-day, being known as the Pennsylvania Railroad Company.



# The Philadelphia & Columbia Railroad

## CHAPTER VII.

### Col. John Stevens' Enterprise.

I have already referred to the persistent efforts made by Colonel John Stevens to have railroads constructed instead of canals. As early as 1823 he obtained by an act of the Legislature of Pennsylvania authority to build a railroad from Philadelphia to Columbia. Mr. Stevens' spirit of enterprise greatly exceeded his financial re-



Col. John Stevens

sources, for he failed to begin the work within a specified time and the State Legislature three years later repealed the Stevens Act and passed another which intended to saddle the State with the burden of building the road. This came to naught, but two years later, in 1828, the Canal Commissioners of the State of Pennsylvania were ordered by the Legislature to put under contract the construction of a railroad from Philadelphia to Columbia via Lancaster. A liberal appropriation of money was made for the purpose and work on the enterprise was commenced with little delay.

During the previous year a survey for a canal or railroad had been made, beginning near Valley Forge on the Schuylkill river and continued westward along the great valley of Chester county. The engineer corps was in charge of Major John Wilson, a well-known Scots engineer, and among his assistants was John Edgar Thomson, afterwards president of the Pennsylvania Railroad.

When the Legislature finally ordered the construction of a railroad from Philadelphia to Columbia, a distance of 82 miles, contracts were made for the grading and bridging of twenty miles of the line at each end. There was so much jealousy in regard to the distribution of appropriations of money by the State, that it was impossible to get an appropriation through the Legislature for any one piece of work without including others of doubtful utility.

The picturesque country lying between Philadelphia and the Susquehanna river did not lend itself to easy railroad building, but the survey was skilfully worked out, the maximum grades being about 30 feet to the mile. At each end there was an inclined plane, that at the Philadelphia terminus having been 2,805 feet long with a rise of 352 feet to the mile. The inclined plane at the Columbia end was 1,800 feet long with a rise of 264 feet to the mile.

The engineers who surveyed the pioneer railroads were prone to establish inclined planes which came from their experience in canal location, where it was necessary to make long stretches of level, then ascend by locks. One of the first improvements made on the State road was to abolish the inclined planes.

### **The Purpose of the Philadelphia & Columbia Railroad**

was to make a through route from Philadelphia to the West as a rival to the Baltimore & Ohio, which was expected to draw Western products to Baltimore, and to hold for Philadelphia some of the business that the Erie Canal was taking to New York. A through route to Pittsburgh was established by means of canals and a portage railroad formed by a series of inclined planes.

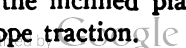
The original scheme of operation for the Philadelphia & Columbia Railroad was to make it a public highway, on which any citizen of the State could operate cars on payment of a fixed toll. Horse power was used exclusively at first, except on the inclined planes, which were worked by stationery engines and rope traction 

### Operating a Railroad as a Private Highway.

Operating a railroad like a private highway worked very badly. Writing on the subject Soloman W. Roberts, a state official, says:

"The experiment of working the road as a public highway was very unsatisfactory. Individuals and firms employed their own drivers, with their own horses and cars. The cars were small, had four wheels and each would carry about seven thousand pounds of freight. Usually four cars made a train, and that number could be taken up and as many let down an inclined plane at one time, and from six to ten such trips could be made in an hour. The drivers were a rough set of fellows and sometimes very stubborn and unmanageable. It was not practicable to make them work by a timetable, and the officers of the road had no power to discharge them.

"When the road had but a single track between the turnouts,

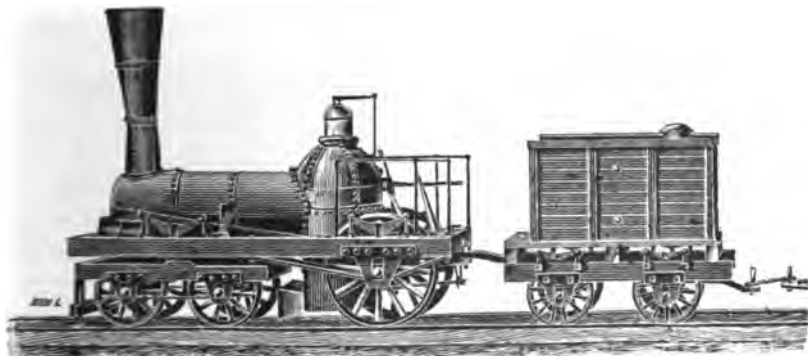

Fig. 60. Baldwin's Lancaster

a large post called a center post was set up half-way between two turnouts, and the rule was made that when two drivers met on the single track, with their cars, the one that had gone beyond the center post had the right to go on and the other that had not reached it had to go back to the turnout which he had left. The road was, in many places, very crooked, and a man could not see far ahead. The way the rule worked was this: when a man left a turnout he would drive very slowly, fearing he might have to turn back, and, as he approached the center post, he would drive faster and faster, to try to get beyond it, and thus drive back any cars that he might meet, and in this way cars have been driven together, and a man killed by being crushed between them."

He also states that when a bill was pending in the State

Legislature, to authorize the purchase of locomotives, he was journeying in a horse car toward Harrisburg and says:

“Two gentlemen were sitting opposite to me who were members of the Legislature from Chester county, one being a senator. The car stopped and a man spoke to my traveling companions, saying that he hoped they would oppose the bill to authorize the purchase of locomotives for the road. The senator said that it should never be done with his consent. Thereupon, as the car drove on, I proceeded to argue the matter, but with poor success; the reply being that the people were taxed to make the railroad, and that the farmers along the line should have the right to drive their own horses and cars on the railroad, as they did their wagons on the Lancaster turnpike, and that if they were not permitted to do it, the railroad would be a nuisance to the people of Lancaster and Chester counties. It required time to overcome this feeling.”

#### **Legislature Consents to the Purchase of Locomotives.**

In spite of their tender mercies for the interests of the farmer and of other horse owners, the Legislature of Pennsylvania were eventually compelled to consent to the use of locomotives on the State Railroad. When this decision was reached, a locomotive was imported from England for use on the Philadelphia & Columbia line. Great expectations were aroused about the wonderful performance this engine would display. As the line was not yet completed at the Philadelphia end, the locomotive was hauled over the turnpike road to Lancaster, where rail connection was reached.

#### **A Balky Locomotive.**

The starting of the locomotive was an event which attracted crowds from far and near, and a holiday was declared for the occasion. Governor Wolf and the leading State officials participated in the ceremonies, and the day being fine a concourse of people gathered to witness what was considered the most interesting show of the period.

Excitement was intense and the movements of the engineer were watched by thousands of eager eyes. He mounted to the deck, manipulated the starting levers, then pulled open the throttle valve, but the engine would not move. After the engineer had exhausted himself in vain to start the engine, the people, like most American crowds, were good natured, rushed in and pushed engine and train into motion. Good nature could not, however, deny that as a starter

the English engine was a failure. It maintained its first reputation and its further history is lost in oblivion.

### Baldwin's "Lancaster."

Shortly afterward Mr. Baldwin, in 1834, built the "Lancaster" (Fig. 60) for the Columbia line. That engine was similar to the E. L. Miller, and worked satisfactorily. The following year two more Baldwin engines were placed on the line. Several other English locomotives were imported and they performed better than the first one, but the American engines were much more popular than those imported.

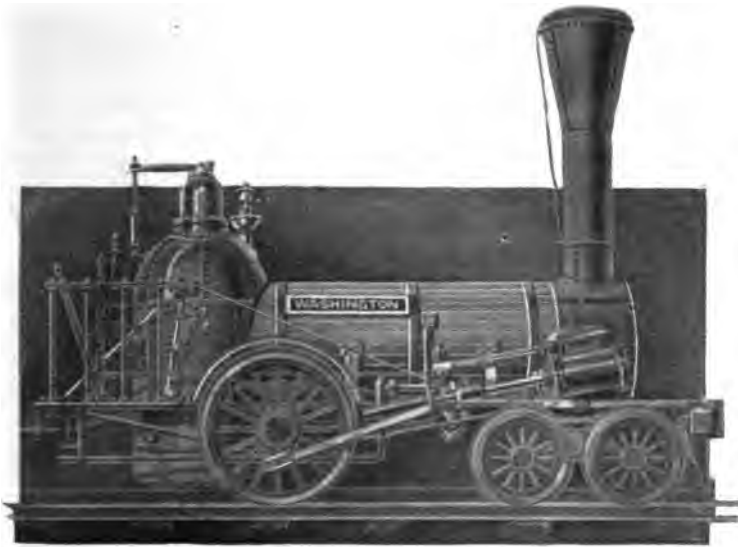

Fig. 61. Norris' Washington

### Rivalry Among Locomotive Builders.

There was some rivalry among locomotive builders to display what their engines could do on the Columbia Railroad. William Norris concluded that he could build a locomotive that would work not only the level section but the inclined planes as well. The engine built for this purpose was called the "Washington," shown in Fig. 61. The engine was of his ordinary six-wheel type, a four-wheel truck in front under the smoke box and a single pair of drivers in front of the fire box. The cylinders, 10x18 inches, were outside the smoke box, the driving wheels were 48 inches diameter. The boiler was of the Bury pattern and carried 90 pounds steam

pressure. The total weight of the engine was 14,400 pounds, the greater part of that resting on the driving wheels. In addition to that the tender coupling was so arranged that part of the tender's weight was thrown upon the driving wheels when the engine was pulling.

### **Triumph of the "Washington."**

When put to a test the Washington hauled a load of 19,200 pounds at a speed of fifteen miles an hour up the inclined plane at the Philadelphia end of the Columbia Railroad, which was 2,800 feet long, rising at a rate of 377 feet to the mile.

Some controversy arose concerning the correctness of this performance, some engineers insisting that it was an impossibility. When subjected to the testimony of figures it is found that the load was quite within the tractive power of the engine so long as no slipping occurred. The tractive power was about 3,000 pounds and the resistance of the train due to gravity was 1,181 pounds. The frictional resistance would not exceed 200 pounds.

Whatever may have been the merits of the performance of the Washington, it brought fame upon its builders and was the means of launching the works upon a prosperous career. There was no longer any sneering at the "Billy" Norris engines being inferior to the best. The "Washington" established a type which continued to be a favorite of the makers until heavier engines were demanded. The fame of the Norris engines for high tractive power brought a few years later the first order given by an English railway company for an American locomotive.

### **The Bar Frame.**

The bar frame was first applied to locomotives in the United States by Coleman Sellers & Son, who built locomotives in Philadelphia for a few years, but the invention became popular principally through its use on the Norris engines. It made a simple form of carriage which ordinary blacksmiths could forge, and, that with its convenience for attaching mechanism which could be conveniently reached, made the bar frame popular with American locomotive designers and users and it came rapidly into favor.

### **The La Fayette.**

The success of the Washington brought an order to Norris from the Baltimore & Ohio for one engine which was the first with a horizontal boiler used on that road, also the first with six wheels.

The engine was delivered in 1837 and was called "La Fayette," Fig. 62. It was of what had become the usual Norris form, outside cylinders, single pair of drivers in front of a haystack fire box, a four-wheel swiveling truck under the smoke box, and inside bar frames. The La Fayette was more squatty in appearance than the Washington, but the power was about the same.

### The Columbia Railroad as a Training School.

The Columbia Railroad early became a sort of training line for railroad men, just as the developed system of the Pennsylvania Railroad became a training school for railroad business on a larger scale, and it held the reputation until it became a hotbed of politics. Men who had worked on the Columbia Railroad claimed to be competent



Fig. 62. La Fayette

to act as leaders and supervisors on any other railroad in the country, and their claims were generally admitted as being well founded. In 1840 they had locomotives built by all American locomotive builders of the day, Baldwin, Norris, Coleman Sellers & Son, Eastwick and Harrison, of Philadelphia; Dotterer & Son, of Reading; John Brandt, of Lancaster; Ross Winans, of Baltimore, and others. Enginemen could experiment with so many different kinds of locomotives that they were considered capable of handling any engine that ran on wheels.

### State Railroad Repair Shops.

Shops were established for the railroad at Parkesburg, 44 miles west of Philadelphia. Great difficulty was at first experienced in effecting repairs in these shops from the fact that the nuts and bolts

on the locomotives procured from a number of different locomotive establishments were all of different sizes and patterns, every bolt having its own corresponding nut. One of the first effective reforms made in this shop was the establishing of standard sizes of nuts and bolts, an action which was highly creditable to the men in charge, for standard sizes were little thought of in those days.

All general repairs of engines were done at the Parkesburg shops, and the running repairs were done at either end of the line by blacksmiths and helpers, whose duty it was to do the work under the direction of the engineers.

The payroll of the Parkesburg shops for September, 1843, gives the number of employees as thirty-one, including one manager, one foreman, thirteen machinists, three blacksmiths, one coppersmith, two file makers, one pattern maker, three carpenters, one stationary engineer, four assistants and one watchman. The aggregate amount of the payroll for these thirty-one men for one month was \$1,087.88, a little over \$35.00 for each person.

The pay-roll of locomotive engineers and firemen employed on the Columbia Railroad during the month of August, 1843, shows that their number was forty—twenty engineers and twenty firemen. The standard rate of wages at that time and for some years previous to and subsequent to that period was \$2.00 per day for engineers and \$1.25 per day for firemen, the time paid for being that in which actual service was performed, and all accounts being verified by affidavits. The total payments for that month were \$990.00 for engineers and \$674.36 for firemen, being \$40.50 for engineers and \$33.21 for firemen. Of the twenty engineers, two were employed on a night line, two on a fast line, and sixteen in running "burden" or freight trains.

### Growth of Columbia Railroad Business.

After locomotives were introduced the business of the Columbia Railroad increased very rapidly, for a report made in 1836 by Mr. A. Mehaffey, superintendent of motive power, gives a table of the names of twenty-seven locomotives which he had at work and the mileage they had made. Of these eleven had been built by Baldwin, one by Long & Norris, four by William Norris, two by Coleman Sellers & Son, five by the Stephensons, three by Young, and one by McClurg & Co., Pittsburg.

In connection with this report Mr. Mehaffey said: "Owing to the infancy of the business of engine building and the deficiency of motive power last spring, some were necessarily purchased which



have been a constant source of vexation, delay and expense. The running of these must ever be an actual loss to the State. Hereafter none will be kept on the road except such as can do full work; all others will be disposed of as soon as possible consistent with the interests of the State. . . . Two of the engines of British make have recently been sold, and it would have been a saving to the Commonwealth had they been given away for nothing the first day they were placed upon the track."

They had a happy-go-lucky way of operating trains on the State road in those days. The stations were nearly all located at taverns, and it was the practice to stop long enough to permit the passengers and train hands to partake of liquid refreshments.

### **Absence of Train Rules.**

The rules for the running of trains were conspicuous by their absence. As late as 1840 trains were started only whenever those in charge of the motive power were assured that there was sufficient traffic along the line to warrant the use of locomotives. Belated trains were searched for by crews that were kept on waiting orders for the purpose. An extra engine with six or eight men was sent out whenever the occasion warranted, curves being "run," that is, a flagman sent out ahead until the delayed train was found.

The operating of this railroad by the State of Pennsylvania was far from being a success. It was managed in the interest of politicians, with the usual result that having interest with the political wire pullers was much more powerful in advancing employees than knowledge of their business or faithful service. The inertia of corruption kept the politicians in control for many years, but their authority was greatly curtailed before the final coup which turned over the whole of the property to the Pennsylvania Railroad Company in 1857.

The practice of giving train passes to politicians and other favored persons originated on the Philadelphia & Columbia Railroad and was carried to excesses never seen elsewhere. By the time the property went into the hands of the Pennsylvania Railroad Company every officeholder in Pennsylvania, from constable to Governor, held an annual pass on the "State Railroad."

# How the United States Worked into Locomotive Building

## CHAPTER VIII.

### **Discouragement of American Industries.**

During the first decade of the railway era in the United States, that is, from 1830 to 1840, the development of the locomotive on native lines was seriously retarded through want of shops where locomotives could be built according to the ideas of American inventors.

As long as the British Government ruled the colonies, the short-sighted policy was pursued of discouraging industries which converted raw material into marketable commodities. The rulers wanted the colonists to devote their energies to the raising of cotton, tobacco and other products of the soil, and to permit the mother country to perform all the manufacturing processes on the raw material. Particular objections were raised against the colonies engaging in iron and steel industries. The rich iron ore found in various localities had tempted the colonists into converting it into marketable iron and steel. This excited so much opposition on the other side of the Atlantic that Parliament repeatedly enacted laws restricting iron making in the colonies, and the exportation of machinery and tools used in metallurgical operations was forbidden. These restrictions helped materially to fan the flames of discontent which culminated in the war of independence.

### **Colonists Take Readily to Mechanical Pursuits.**

After independence was won the people turned readily to industrial pursuits, but the art of machine making developed slowly, and it had only about fifty years to grow when the railroad era began. The people in the American colonies were nearly all brought up to the use of the axe, the saw, the blacksmith's hammer and other tools, and most of them took readily to mechanical pursuits.

In fact, by training and tradition American business men, farmers and others came to consider themselves as good mechanics as those trained to the business, a peculiarity which led men to design and build locomotives without any special training in the mechanic arts.

Up to the time that railroad building began, the principal mechanical establishments were forges, wheelwright shops and millwright shops, the three sometimes being combined. In the

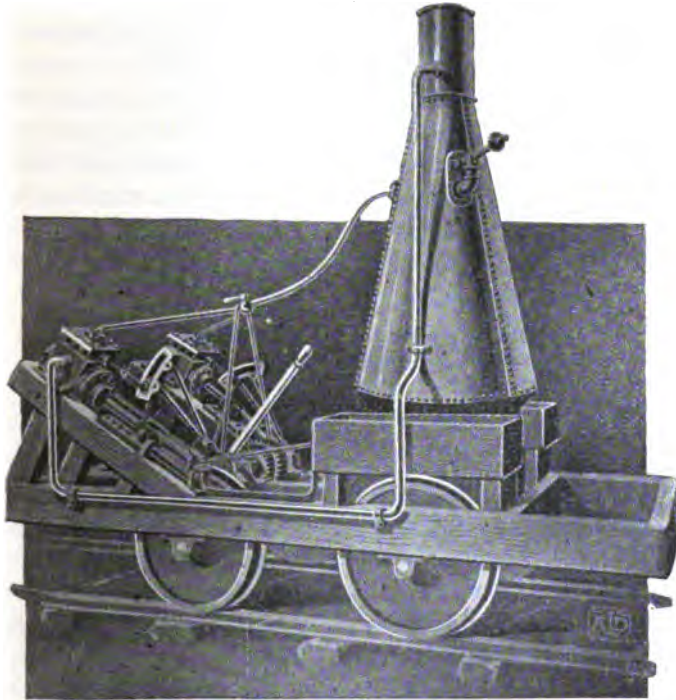

Fig. 63. James' Engine, 1832

large cities there were "foundries" which did all sort of jobbing in metals, and there were also a few jobbing shops devoted to repairing machinery, mostly of tugs and steamboats.

#### West Point Foundry.

In 1830 the West Point Foundry, Beach street, New York, owned by Messrs. Kimball, was one of the most important machine shops in the United States, and there naturally went the pioneer locomotive designers to have their engines made. The capacity of

the place was, however, limited, locomotive building was not regarded as a promising business, and the concern had all the steamboat and general work it could attend to. On this account orders for the construction of locomotives were refused after four or five had been built.

### **James' Engine Building Shop.**

As early as 1828 William T. James, an inventive genius who had a small machine shop in Eldridge Court, New York, began to experiment in building road locomotives. His first production was a small locomotive with cylinders 2x4 inches, which he ran upon a circular track pulling a train of miniature cars. It was an attractive and popular exhibition, and indicated the interest people were taking in steam applied to land transportation. James afterward built several steam road carriages which were fairly successful considering the kind of roads they had to travel on. He also built two railroad locomotives, one for the Baltimore & Ohio competition, Fig. 63, which will be described in due course.

### **Small Machine Owners as Locomotive Builders.**

As agitation in favor of railroad building intensified, various owners of small machine shops displayed willingness to engage in building locomotives which then were no larger than the modern fire engine. The first practical move in this direction was made when Col. Stephen Long, of the United States Topographical Engineers, and Jonathan Knight, the first chief engineer of the Baltimore & Ohio, who obtained a charter from the State of Pennsylvania for the American Steam Carriage Company. The intention was to build steam locomotives, but two years elapsed before they built their first engine, and then William Norris supervised the work.

### **Davis & Gartner as Locomotive Builders.**

About the time that Long and Knight were organizing their steam carriage company in Philadelphia, Phineas Davis, a watchmaker, of York, Pa., was interesting himself keenly in locomotives, and studying everything he could find about their construction and operation. When the Baltimore & Ohio directors offered a prize for a locomotive, Davis formed a partnership with a machinist named Gartner, and they proceeded to build a locomotive which was completed in a few months and was called the "York," par-

ticalars of which have already been published. The success of the "York" brought to Davis & Gartner orders for two more engines. The second engine of their build was called the "Atlantic," already described, weighed about 14,500 pounds, then considered a little beyond the safe weight for locomotives running on strap rails. The finger marks of Ross Winans were very prominent on this engine, which had several important improvements over the "York," and was regarded for the time as the standard of weight and power for a grasshopper engine. The third engine built in the "York" shops was called the "Traveller." It had the power at first transmitted direct to a cranked axle, but that breaking, the engine was changed to conform to the design of the Atlantic, which transmitted the power through gearing and a supplementary driving shaft. The "Traveller" completed the locomotive building of Davis & Gartner, for the Baltimore & Ohio Railroad, as the company built shops for themselves which were ready in 1833, when it was expected that all locomotives required could be built and repaired.

#### **Watchmakers as Locomotive Builders.**

In connection with the engineering work of Phineas Davis, it is interesting to note that he was a watchmaker by trade, and that two others who built locomotives for the Baltimore & Ohio competition were trained to the same business. Matthias W. Baldwin, who established the most successful building locomotive works in the world, was trained to the trade of a jeweler. This is a good illustration of how native genius will assert itself and defy adverse circumstances of early training.

#### **Costell Organizes Locomotive Building Shops.**

Another aspirant at establishing a locomotive building shop was Stacey Costell, a watchmaker, who in 1831 organized the Pennsylvania Locomotive Works, of Philadelphia. Under the direction of Costell a locomotive with double acting oscillating cylinders was built in the works for the Baltimore & Ohio competition which did not prove a success, and its failure led to the closing up of the locomotive building shop for good.

There were several other tentative shops started where a few locomotives were built, but most of them failed. Those which succeeded in keeping at work for five years have become historical.

### Origin of the Baldwin Locomotive Works.

The pioneer successful locomotive building shop was started by Matthias W. Baldwin in 1831. Mr. Baldwin learned the jeweler trade in Philadelphia, and in 1819 opened a small shop on his own account. Six years later he entered into partnership with David Mason, a machinist, to engage in the manufacture of book binders' tools and cylinders for calico printing. The business was so successful that steam power became necessary, and Mr. Baldwin designed and built an engine which proved particularly well adapted for the requirements of the shop. The success of this engine led the firm into the business of engine building, and turned Mr. Baldwin's attention to steam engineering, and the way was prepared for his grappling the difficult problems of locomotive construction.



Fig. 64. Baldwin's First Engine

### Baldwin Builds a Stationary Engine.

The first stationary engine (Fig. 64) built by Mr. Baldwin prior to 1830 is still in good order and is capable of performing economical work. It has successively supplied the power in six different departments as they have been opened, from time to time, in the growth of the business.

The engine is preserved in the Baldwin Locomotive Works as a historical relic, and is an object of interest to visitors who like to examine mechanical antiquities.

### Interest in Mechanic Arts in Philadelphia.

Philadelphia has always taken the lead in the development of the mechanic arts in the United States. It was therefore natural

that public curiosity should be excited by everything relating to the railroads that were creating much discussion at home and abroad. Everything relating to this novel form of land transportation must have been the town talk of intelligent people in Philadelphia in 1830 and 1831, for railroad building schemes for the neighborhood were very numerous, as may be judged from the fact that Pennsylvania State reports intimated that there were sixty-seven railroads in operation in the State in 1832.

Most of them were small, of course, and some of them were crude tramways with wooden rails, but their existence indicated vigorous activity among railroad promoters. The coal that was being mined in increasing quantities had to be conveyed as cheaply as possible to points where water carriage would convey it to a market, and a wooden tramway enabled a horse to haul a much heavier load than could be moved over the execrable roads then the rule.

#### **Baldwin Builds a Small Locomotive.**

In 1830 Franklin Peale, then proprietor of the Philadelphia Museum, resolved to gratify public curiosity concerning railroads by introducing into his establishment a small working locomotive and train of cars. He naturally applied to Mr. Baldwin to make the engine, for that gentleman had become the best authority on engine building in the Quaker City. The work was duly carried out and the engine was put into operation on April 15, 1831, pulling two small passenger cars which seated four passengers, around a circular track in the museum.

That introduced the attention of Mr. Baldwin to locomotives, but his subsequent experience will be the subject of a separate chapter.

#### **Colonel Long's First Locomotive.**

In 1830 Colonel Long, president of the American Steam Carriage Co., built in Philadelphia a locomotive which had a boiler with a combustion chamber in the middle, but otherwise it resembled the improved English locomotives. In working order the engine weighed about 8,000 pounds. It was tried very exhaustively on the Newcastle & Frenchtown Railroad, but its performance resembled that of a pioneer Scottish locomotive, which the builders wished to recommend through the influence of Napier, a celebrated engineer. Napier had been invited to witness the test of the loco-

motive which had been designed by an ambitious amateur. The promoters of the engine succeeded in bringing Napier into the presence of capitalists; but when the attempt was made to have the engineer testify in favor of the engine's performance nothing was forthcoming but a succession of protesting grunts. Losing patience the inventor exclaimed, "You must admit that you saw the engine running." "You may call that running," replied Napier, who stuttered, "all I saw was you fellows sho-sho-shovin' her."

The trials of Long's engine were a succession of failures because the boiler would not make the steam required. I believe that was the first engine with a combustion chamber, the most deceptive device ever applied to a locomotive boiler. A designer could prove by the most convincing reasoning that a combustion chamber must improve the steaming properties of a boiler and effect saving of fuel, but experience has always proved it to have the opposite effect.

### Long & Norris' "Black Hawk."

Colonel Long was by no means discouraged by the failure of his first locomotive, but entered very cheerfully with William Norris into what was intended to be a permanent business of building locomotives. The records now to be found concerning the early locomotives built by Long & Norris are very meager. Their first engine which they built was called the "Black Hawk." It was designed by Colonel Long and was an extraordinary production. The designer aimed at novelty and succeeded in making a locomotive different from anything built before or since. There was not then much of a beaten path in locomotive designing, and what there was Long disdained to follow. He proposed burning hard coal by natural draft only, and employed an unusually high chimney which could be lowered when passing under bridges. Later on he made the chimney telescopic and obtained a patent on the invention.

The boiler was peculiar and consisted of two cylinders, about 20 inches diameter, secured side by side (as was also done by Horatio Allen) and forming the roof of a detachable fire box which had water sides but no crown except that formed by the bottom of the twin boilers. A notch was cut half way through these two cylinders on their lower half diameters, about midway of the length of the fire box, directly over the fire, and from these notches flues about two inches diameter and about seven feet



long, passed through the water space of each cylinder portion of the boiler to this smoke box. The fire gases had another passage besides the flues, for a channel was provided to let them flow under the boilers to the smoke box.

The engine was carried on four wheels and had inside cylinders with crank axle. A cam cut-off, then greatly in favor on the engines of river steamers, was used.

### Long & Norris, Locomotive Builders.

Long & Norris became successors of the American Steam Carriage Company. They began to build locomotives in Philadelphia about the same time as Mr. Baldwin, and had a very checkered career for several years, but Mr. Norris persevered and made the business successful. The Norris Works built one locomotive

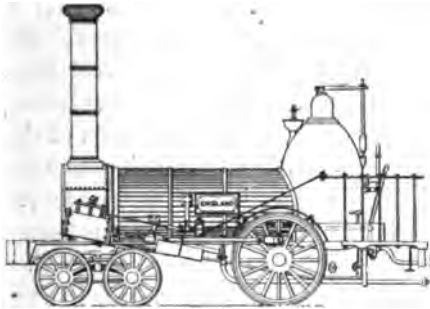

Fig. 65 Norris' England

in 1832, one in 1833, one in 1834, two in 1835, eight in 1836, and so on in increasing scale up to one hundred in 1854. Upward of 1,000 locomotives were built in the Norris works, and of these 17 were exported to the Birmingham & Gloucester Railway, of England, and 153 to the continent of Europe.

### Norris Engines for English Railway.

William Norris brought an international reputation to American locomotives through the work he did for the Birmingham & Gloucester Railway. The locating engineer of that railway had made a serious blunder in having laid out part of what was intended as a through line with a grade of 143 feet to the mile for a stretch of two miles. Finding that the British locomotives available were not equal to the task of operating this incline, Captain Moorson, the chief engineer, ordered eight locomotives from

Norris & Co., and they performed the work very satisfactorily.

The engines, Fig. 65, were of the type that had made their mark on the Philadelphia & Columbia Railroad. They weighed about 22,000 pounds, had cylinders 10 1/2 x 18 inches, and a single pair of drivers 48 inches diameter.

A ludicrous incident happened to Edward Bury, the noted locomotive designer, in connection with the operating of the Licky Incline, as the grade referred to was called. He declared that if American locomotives could climb that incline hauling a certain load, he would furnish engines that would do the same thing. The opportunity came and Mr. Bury had the humiliation of having his engine stall fast when about half way up the grade.

There was a keen rivalry between Baldwin and Norris in the early days, and the engines of each had their friends and detractors. The engines of the two builders were developed on similar lines so far as power and weight were concerned. Baldwin placed the drivers of his engines behind the fire box and Norris put them in front of the fire box. The merits of the relative positions excited no end of discussion among the railroad men of that day.

William Norris afterward established locomotive building works in Vienna, and Colburn, author of a well-known history of the locomotive, says that his models of locomotives were reproduced with trifling alterations by M. Meyer, who still enjoys the credit of originating a variety of valve gear which was introduced from the United States.

### The James Locomotive.

When Philadelphia was stirred up with locomotive designing schemes in 1832, a candidate for honors as a locomotive designer and builder was busy in New York. This was William T. James, who built the sixth peripatetic engine turned out of his shop, which was a most remarkable engine in some respects. An authentic drawing of this engine has been preserved, and its reproduction is shown in Fig. 63, already referred to as having been entered for the Baltimore & Ohio Railroad competition.

As will be seen, the engine was carried on an oblong wooden frame, resting upon four wheels. The boiler was upright after the Baltimore & Ohio fashion, for which it was intended, but it had no flues, the principal heating surface being in the fire box. Heat was transmitted to the water by means of projecting teats which must have made it weak, for the boiler exploded, making

an end of this interesting locomotive. The cylinders, 10 x 10 inches in front, were set at an angle of 30 degrees and transmitted the power through a supplementary shaft which engaged with the driving axle by gears of two sizes that were intended to increase the power or the speed as required in the same way that automobiles are now constructed.

The striking feature of the engine was the reversing gear which was the link motion, operated by two fixed eccentrics, the link being afterward lost sight of and reinvented ten years subsequently by William Williams, a young draftsman in the works of Robert Stephenson & Co., Newcastle, and the credit for the invention stolen by William Howe, a mechanic in the same works. There is no question that the link was first invented by James and that he understood its peculiarity of varying the point of cut-off, an action which was first discovered when they were setting the valves. The writer has frequently talked with Samuel B. Dougherty, who was foreman in the James shop and an intelligent helper and adviser, concerning the construction and designing of pioneer railroad machinery.

Dougherty lived till about 1890.

### Diversity Among Pioneer Locomotives.

In 1832 it looked as if there would be as much diversity in the general appearance of locomotive engines as there were in the marine engines up to that time. No locomotive had appeared in America to set the fashion as the Rocket did in Europe. Cooper's Tom Thumb had vertical engine and boiler, so it was natural that the type should have imitators, although a vertical engine, more especially a vertical boiler, was not adapted to an engine that had to jolt over an uneven track.

The first locomotive built for practical work, the Best Friend, had a vertical boiler, but the second engine built under the same supervision, the West Point, had a horizontal boiler, and the Baltimore & Ohio made their standard locomotives for years with upright boilers. The De Witt Clinton, the third locomotive built by the West Point Foundry Company, had a horizontal boiler, but nothing about it indicated that the designer was not original in his ideas. There were five locomotives, built for the purpose of competing for the reward offered by the Baltimore & Ohio Railroad Company, and none of them had any resemblance to each other,

the only common grounds of all designs being that they had boilers for steam generation and mechanism through which it was intended that the steam should produce locomotion, although it did not always accomplish that.

### Baldwin's "Miller" Established a National Type.

Confusion and uncertainty reigned among locomotive designers as to the fittest form such an engine ought to have, until Baldwin built his second engine in 1834. There were freaks afterward brought forth that departed radically from the design of the "E. L. Miller," but they exerted no influence on the development of the American locomotive. The American locomotive of today was developed directly from the E. L. Miller, just as certainly as a huge oak tree grows up from the small acorn.

An engraving of the E. L. Miller appears in Fig. 35, on page 60. The leading features are a horizontal boiler with Bury's haystack fire box, one pair of driving wheels, located behind the fire box, the Jarvis four-wheel swiveling truck under the smoke box, and outside wooden frames sheathed with iron plates. The cylinders, 10x16 inches, are secured between the smoke box and frames, and transmit the power to the driving wheels through a half-crank axle. This was a decided improvement in crank axles, in times when the facilities for making large sound forgings were limited, for the wheel is made to form one side of the axle, thereby materially strengthening what had come to be considered a weak member of inside-connected locomotives. The engine weighed in working order about 16,600 pounds.

### Some Peculiarities of Locomotive Development.

There have been several peculiarities observed in the development of machines that have had their counterpart in the locomotive engine. The controlling aim of an original inventor is to make the apparatus he is engaged upon to actuate. The first production then is, as a rule, a crude device. Then he or others proceed to its elaboration with the view of increasing the efficiency or developing its self-acting properties. This line of would-be improvement is nearly always pursued until a condition of complication is reached which calls for radical remedies. Then they return to first principles and the fittest machine is developed.

The locomotive engine passed through this process. It was first composed of merely the driving elements and these were gradually expanded by the addition of attachments until it became a very complex apparatus liable to failure from breakage of its many parts. Baldwin and Norris both perceived the advantage of simplicity, and their designs provided a foundation on which the finest locomotives of the Twentieth Century have been built.

# Triumphs of Baldwin

## CHAPTER IX.

### Baldwin Locomotive Works.

In a previous chapter I mentioned that Matthias W. Baldwin having gained the distinction of being a particularly skilful mechanic and engineer, was given the work of building a model



Matthias W. Baldwin

locomotive to be used in the Peale Museum, of Philadelphia, to gratify the public curiosity as to what a locomotive and train of cars looked like.

### Baldwin Receives Order for Road Locomotive.

Shortly after the Peale model engine was put to work, the Philadelphia, Germantown & Norristown Railroad Company ordered from Mr. Baldwin a locomotive to operate their line, six miles of which had just been finished, and was operated by horses. The Camden & Amboy Railroad had imported their famous "John Bull" from the works of Robert Stephenson & Co., a short time before, and this engine was stored in a shed at Bordentown. Mr.

Baldwin, in company with his friend, Mr. Peale, visited Borden-town and carefully examined the parts of the engine, which were not yet put together. He took some sketches and memoranda and with the aid of these undertook to build a full-size locomotive.

### The "John Bull."

The English engine which Baldwin used as a pattern has generally been called of the "Planet" class of engine. That is not exactly correct, for the so-called Planet type of engine, shown in Fig. 15, page 32, had one pair of big driving wheels placed in front of the fire box, and one pair of small carrying wheels placed under the smoke box. The "John Bull" had two pairs of wheels the same size coupled. The first engine of that type

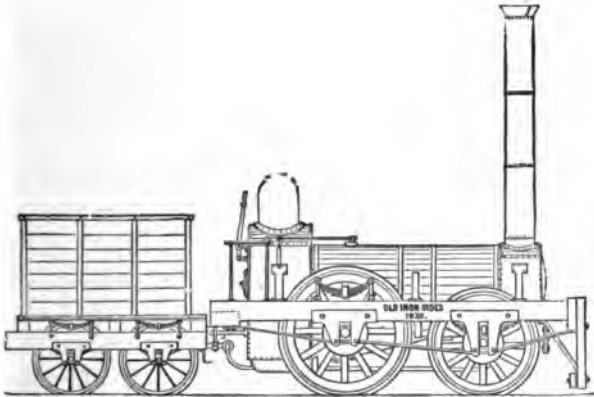

FIG 65 "Old Ironsides"

was built for the Liverpool & Manchester Railway in 1831, and was called the "Samson." Nearly all the locomotives which Robert Stephenson & Co. sent to the United States were of this Samson pattern.

### "Old Ironsides" Built.

Mr. Baldwin proceeded with the building of the engine for the Philadelphia, Germantown & Norristown Railroad, and it was first tried November 23, 1832. It was called the "Old Ironsides" (Fig. 66). It was a four-wheel engine with the driving wheels in front of the fire box and the carrying wheels close behind the smoke box. In working order the engine weighed about 11,000 pounds. The cylinders were 9½x18 inches, the driving wheels were 54 inches, and the front wheels 45 inches diameter. The boiler was 30

inches diameter and contained 72 copper flues  $1\frac{1}{2}$  inches by 7 feet.

The builder experienced considerable trouble before he got the "Old Ironsides" to work satisfactorily, but the difficulties encountered were as nothing compared with those the English builders had to overcome.

The engine was put into regular train service with as little delay as possible, and the railroad company displayed solicitude about the care of the engine which was in striking contrast to latter day practice. They advertised that their new locomotive engine would haul cars at certain times if the weather was fair, but when it rained the cars would be pulled by horses.

### Great Speed Attained by the "Old Ironsides."

According to an article which appeared in the *Railroad Journal* for 1833, Dr. Paterson, of the University of Virginia, and Mr. Peale, rode on the engine and kept the time when, with its regular train, it ran one mile in 58 seconds, and  $2\frac{1}{4}$  miles in 3 minutes and 22 seconds.

### Organizing a Shop.

The most important work which Mr. Baldwin performed, in connection with the building of his first locomotives, was the organizing of shops where such work could be carried on. He was very much in the position that James Watt was when building one of his first engines. After the cylinder was bored he reported that the work was so well done that he could not push a half crown between the piston and the cylinder at any place. Mr. Baldwin suffered from the same want of skilled mechanics, and had to instruct workmen besides designing and building many of the tools employed.

Mr. Baldwin's apprentice hand was tried upon the Old Ironsides, and his next venture in the locomotive building line displayed the journeyman's skill. That was on the E. L. Miller, noticed in last chapter. Mr. Baldwin devoted much intelligent attention throughout his entire business career to the improving of methods of locomotive manufacture, but laboring to perfect the engine itself on sound engineering lines was his life's work. For a time he was contented to build the Miller type of locomotive, but his mind seemed to be constantly occupied in working out perfections of details.



### Baldwin's First Valve Gear.

The valve motion, illustrated and described in the chapter on Valve Motion, a modification of the Scottish Carmichael marine engine motion, was given by a single fixed eccentric for each cylinder. Each eccentric strap had two arms attached to it, one above and the other below, and, as the driving axle was back of the fire box, these arms were prolonged backward under the footboard, with a hook on the inner side of the end of each. The rocking shaft had arms above and below its axis, and the hooks of the two rods of each eccentric were moved by hand levers so as to engage with either arm, thus producing forward or backward motion. This form of single eccentric valve gear, which was peculiar to the Baldwin engines, was preferred in the interest of simplicity in the working parts and was used for several years.

### Severe Simplicity Aimed At.

The E. L. Miller had very little that was decidedly original, but old forms were combined in a shape that produced the best locomotive engine then built. Many other highly successful inventions have been worked out in a similar manner, among which may be mentioned the steam engine itself, the train air brake, the Richardson safety valve, all modern injectors and sight-feed lubricators.

The most conspicuous feature of the engine was simplicity of parts. A boiler that any person could understand and that any boiler maker could repair, a pair of cylinders securely fastened between smoke box and frame, a valve motion having no mystery, running gear that combined strength with simplicity made a combination eminently suitable for its day and generation.

### Baldwin's Driving Wheels.

The leading policy which Mr. Baldwin adhered to, as a locomotive builder, was to reproduce the same general form of engine and to effect improvements on details. This had an excellent influence on the railway machinery users of the day, and restrained that tendency of self-glorification which results in making things different from what others are using. The pioneer railroad companies had experienced much annoyance from the driving wheels failing. Baldwin invented a wheel, Fig. 67, in which the hub and spokes were of cast iron, cast together. The spokes were cast without a rim, and

terminated in segment flanges, each spoke having a separate flange disconnected from the others. By this means the injurious effects of unequal expansion and contraction was prevented. The flanges bore against wooden felloes, made in two thicknesses and put together so as to break joints. Around the whole the tire was passed and secured by bolts. This made a good wheel which held its own until the molder's art advanced sufficiently to cast a reliable cast iron wheel center.

It is a pity that the idea of making an elastic driving wheel center did not take more of a hold on locomotive builders. The unresilient blow of the modern driving wheel must impart most destructive blows to the permanent way, and has given rise to a great deal of discussion about the so-called "hammer blow."

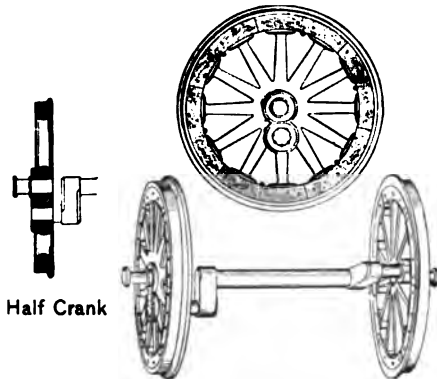

Fig. 67. Baldwin's Improved Driving Wheels

### Ground Pipe Joints.

One of the most valuable inventions which Mr. Baldwin introduced early in his career, was ground pipe joints. All other locomotive builders made joint of canvas and red lead, which were continually blowing out, causing annoying delay and materially increasing the cost of maintenance. The trouble with the steam joints prevented the English builders from carrying more than 60 or 70 pounds boiler pressure without danger to the joints, while the Baldwin engines were carrying 120 pounds without failure. The red lead joints gave so much trouble with three English engines on the Pennsylvania State Railroad that they had to be sold because the engineers refused to run engines that failed so often as these did.

### Outside Tube Ferrules.

Another very important improvement introduced by Mr. Baldwin was in boiler tubes, which consisted in driving a copper ferrule or thimble on the outside of the end and soldering it in place, instead of driving a thimble inside the tube end. The new practice strengthened the end of the tube and left the inside unobstructed, so that cinders passed freely out.

### Traction Increaser.

In 1834, Mr. E. L. Miller secured a patent on a traction increaser, which transferred part of the weight of the tender upon the driving wheels. Mr. Baldwin applied this device to many locomotives, and subsequently purchased the entire right to use the invention. The traction increaser is one of those mistakes designed to repair a mistake, and whose absence is better than its presence. But it proved useful sometimes when the locomotive was under development.

### Brass Tires.

Among the tentative improvements introduced on Baldwin's early engines, were a set of brass tires which he supposed would increase the adhesion, but they wore out so rapidly that they were abandoned for iron. The tires made by S. Vail & Sons, Morristown, N. J., the only American maker, and those imported from England were very thin, only about  $1\frac{1}{2}$  inch. Baldwin ordered a supply from England three inches thick, and had very great difficulty in getting the order filled.

The making of cylindrical pedestals was early introduced, pedestals and axle boxes having been finished on a lathe, a method which was cheap and ensured a proper fit. Chilled wheels were introduced as a means of increasing the durability of the engines.

### Good Workmanship.

Good workmanship and attention to details made the Baldwin locomotives unusually popular. Mr. L. A. Sykes, engineer of the New Jersey Transportation Company, wrote, in 1838, that he could draw with his engine twenty four-wheeled cars with twenty-six passengers each, at a speed of twenty to twenty-five miles per hour over grades of twenty-six feet per mile. As to simplicity of construction, small liability to get out of order, economy of re-

pairs and ease to the road, Baldwin's engines stand unrivaled. He considered the simplicity of the engine, the arrangement of the working parts, and the distribution of weight, far superior to any engine he had ever seen, either of American or English manufacture. He had no hesitation in saying that the Baldwin engine will do the same amount of work with much less repairs, either to the engine or the track, than any other engine.

### Interchangeability of Parts.

One of the very important improvements introduced by Mr. Baldwin about 1838, was making the parts of locomotives interchangeable, or at least he made a start in that direction. The making of parts of mechanism to certain exact sizes, so that one part would fit with any machine of the same species, is essentially an American idea and was first introduced in the making of fire-arms by Eli Whitney, famous as the inventor of the cotton gin. The interchangeable idea worked its way slowly into favor with American mechanics, but it is now used almost universally in all industries where constant reproduction of parts prevails. It was greatly to the credit of Mr. Baldwin that he perceived the advantage of the system at a time when very few of the mechanical trades had risen above the fit and try process.

It took a long time to develop the system so that standard gauges have the means of all-shop measurements, but a beginning of the good work was instituted through the acumen of the originator of the Baldwin Locomotive Works.

### A Conservative Locomotive Builder.

Mr. Baldwin was essentially a conservative man, and held with strong persistency to any form or device that had proved itself satisfactory. The Miller type of locomotive with a single pair of driving wheels and a four-wheel truck had proved so successful that the builder displayed great reluctance to adopt an advanced form. It pleased him much better to perfect details and to invent improved accessories than to change the form of his idol. Events, however, dragged him along resisting. In 1836, Henry R. Campbell had designed his eight-wheel engine that became the prototype of the American locomotive, and pressure was put upon Mr. Baldwin to adopt that form. In 1838 he wrote to a correspondent that he did not think there was any advantage in an eight-wheel

engine. There being three points of contact it would not turn a curve, he said, without slipping one or the other pair of wheels sideways. Another objection he raised was in the multiplicity of machinery and the difficulty of maintaining four driving wheels all exactly of the same size.

### Fallacies About Grade Climbing.

For many years a belief prevailed among railroad men and scientists that grades over one per cent. could not be climbed by locomotives unless they were provided with geared wheels or some other special means of increasing adhesion. As most of the early American railroads were cheaply built, conforming to the surface of the country without tunnel, deep cutting or expensive embank-

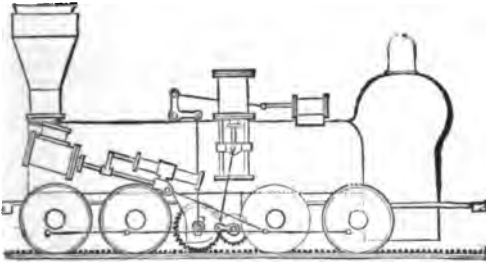

Fig. 68. Geared Locomotive

ments, the use of inclined planes operated by stationary engines and cable traction was becoming too common for expeditious train service. The small single driver engines were very indifferent hill climbers. Feeling that something must be done to secure more adhesion, in 1839 Mr. Baldwin secured a patent on a geared engine in which an independent shaft was placed between the two axles of the truck and connected by cranks and coupling rods with the outside of the driving wheels. It was an attempt to utilize the truck wheels for adhesion.

One engine of this kind was built and it performed wonderful feats of trains hauling on the Philadelphia & Reading Railroad, but it never was duplicated. The patent for the geared engine covered a variety of devices, as follows:

1. A method of operating a fan, or blowing-wheel, for the purpose of blowing the fire. The fan was to be placed under the footboard, and driven by the friction of a grooved pulley in contact with the flange of the driving wheel.

2. The substitution of a metallic stuffing, consisting of wire, for the hemp, wool, or other material which had been employed in stuffing-boxes.

3. The placing of the springs of the engine truck so as to obviate the evil of the locking of the wheels when the truck frame vibrates from the center pin vertically. Spiral as well as semi-elliptic springs placed at each end of the truck frame were specified. The spiral spring is described as received in two cups—one above and one below. The cups were connected together at their centers by a pin upon one and a socket in the other, so that the cups could approach toward or recede from each other and still preserve their parallelism.

4. An improvement in the manner of constructing the iron

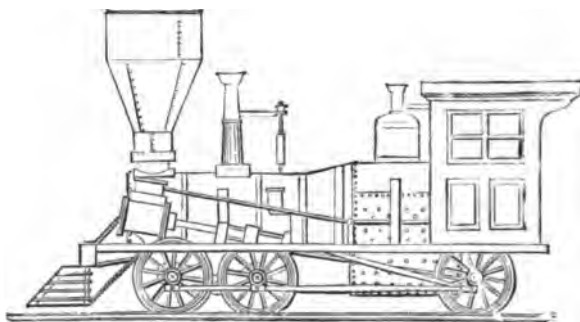

Fig. 69. Grade Climbing Engine

frames of locomotives, by making the pedestals in one piece with, and constituting part of, the frames.

5. The employment of spiral springs in connection with cylindrical pedestals and boxes. A single spiral was at first used, but not proving sufficiently strong, a combination or nest of spirals curving alternately in opposite directions was afterward employed. Each spiral had its bearing in a spiral recess in the pedestal.

### Madison and Indianapolis Railroad Geared Engine.

Six years later a novel form of hill-climbing engine was built for the Madison & Indianapolis Railroad to operate a grade 310 feet to the mile. The engine had eight wheels, 42 inches diameter, connected and worked in the usual manner, with outside inclined cylinders 15x20 inches. A second pair of cylinders, 17x18 inches, was placed vertically over the boiler, as

shown. These cylinders transmitted power to a crank shaft under the boiler which carried a single cog wheel at its center engaging with another twice its diameter on a second shaft adjacent to it and on the same plane. The latter cog wheel worked on a rack rail placed in the middle of the track.

The engine worked satisfactorily and another one was built for the same company three years later. They were kept at work until a line with easier grades was built.

### Successful Grade Climbers.

The geared engine having failed to attract popular favor, Mr. Baldwin continued to work on the problem of utilizing more of the weight of the engine for adhesion. The idea of coupling the

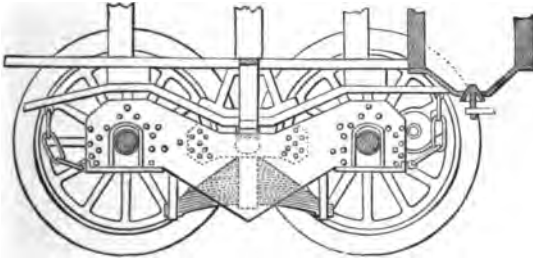

Fig. 70. Baldwin's Flexible Truck

wheels by rods was considered, but he decided that some method of securing flexibility of wheel base must be devised. It resulted in the inventing of the six-wheel connected locomotive with the four front drivers combined in a flexible truck, Fig. 69.

A report made in 1853 by Charles Ellet, chief engineer of the Virginia Central Railroad, of the performance of some Baldwin engines on a temporary track across the Blue Ridge, gave the engineering world new insight into the grade climbing possibilities of locomotives having ordinary tires. The grade was over 300 feet to the mile, covered with sharp curves, and it was worked by six-wheel connected Baldwin engines with flexible truck. The engines had cylinders  $16\frac{1}{2} \times 20$  inches, drivers 42 inches diameter and weighed in working order 55,000 pounds. They hauled a load of fifty tons and had sufficient power to start the train easily from a water tank located in the middle of the steepest grade. This class of engine is illustrated in Fig. 69, but the hill climbers had the wheels set closer.

### Flexible Driving Wheel Base.

Mr. Baldwin was not one of the first builders to favor multi-coupled engines, until he invented his four-wheel, flexible truck (Fig. 70) and single pair of rigid driving wheels, making a form of running gear that was highly popular for freight traffic. The development of this was the eight-wheel connected engine with the flexible truck leading, coupled with two pairs of drivers, which is illustrated in Fig. 71.

A flexible truck having wheels coupled to one or more pairs of rigid driving wheels looks like a mechanical anomaly, but that was what Mr. Baldwin successfully introduced into locomotive



Fig. 71. Old Baldwin.

practice. The truck wheels had inside journals running in boxes, held by two wide and deep wrought iron beams, one on each side. These beams were not connected. The pedestals secured on the beams were bored out cylindrically and into them cylindrical boxes were fitted. The engine frame on each side was directly over the truck beam, and a spherical pin running down from the frame, bore in a socket in the beam midway between the two axles. Thus each side beam independently could turn horizontally or vertically under the spherical pin, and the cylindrical boxes could also turn in the pedestals. In passing a curve the truck beams acted like a parallel ruler. The coupling rods were made with cylindrical



brasses, forming ball and socket joints that enabled them to accommodate themselves to the lateral movement of the wheels.

One of these engines is shown in Fig. 71, which had been in continual service in Cuba for over 50 years, and is still in good working order in 1906.

The flexible driving wheel arrangement was particularly well adapted to the fragile track which was long characteristic of American railroads. It enabled the Baldwin Locomotive Works to take a prominent part in the introduction of powerful locomotives for hauling coal and other minerals, and it made an easy transition to the application of the leading truck on coupled engines.

To pursue in detail the progress of locomotive building and development in the Baldwin Locomotive Works, would be to tell the history of the growth of the locomotive. Mr. Baldwin shared in the mistakes made by others taking a part in the development of a new industry, and his strong personality served to emphasize his mistakes; but on the whole his keen insight into the merits of details and his matured judgment on proposed improvements, kept him from straying far from the way of true progress.

### Baldwin's Improved Valve Gears.

Although Mr. Baldwin was a firm believer in his single eccentric valve gear, he invented several improvements designed to provide for the expansion of the steam. About 1845 he introduced what was known as the "half-stroke cut-off," which was highly popular for a few years.

In this device the steam chest was separated by a horizontal plate into an upper and lower chamber. In the upper part a valve was worked by a separate eccentric and admitted steam through a port in the dividing plate to the lower steam chamber. The cut-off valve rod engaged with the rocker arm and could be thrown out when the action of the cut-off was not wanted. The point of cut-off was determined by the setting of the eccentric, and was generally at half stroke. This form of valve gear was used mostly for passenger engines.

About 1840 a demand for the link motion began to arise in the United States. In 1844 Mr. Baldwin built an engine for a railway in Austria, and applied upon it a sort of link motion, the link having a truncated V section, and illustrated in the chapter on valve motion. Mr. Baldwin was opposed to the link motion and resisted its introduction for several years. In 1853 he adopted

a variable cut-off motion which was said to effect an excellent distribution of steam when in good working order. The device consisted of two valves, the upper sliding upon the lower and worked by an eccentric and rocker shaft in the usual manner. The upper arm of the rock shaft was curved so as to form a radius arm on which a sliding block, forming the upper termination of the upper valve rod, could be adjusted and held at varying distance from the axis, thus producing a variable travel of the upper valve.

The motion developed various defects in service and several improvements were patented, but the railroad world of that day was infected with the link motion malady, as it has been smitten with

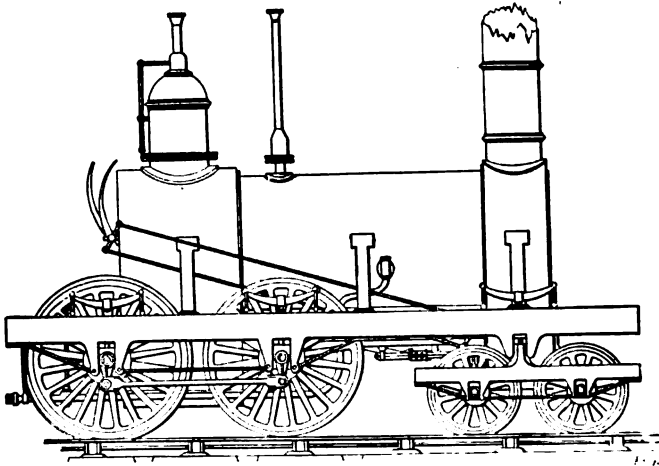

Fig. 72. Campbell's 8-Wheel Locomotive, 1836

other less desirable manias since that time, and in 1854 Mr. Baldwin was influenced to apply the link motion to an engine built for the Central Railroad of Georgia, the entering wedge that soon forced out all other forms of valve motion.

#### Improvements on Locomotive Boilers.

The Baldwin Locomotive Works were noted for the steady work they did in improving the locomotive boiler, and for their readiness to apply attachments which promised to increase the steam generating properties of the boiler. As early as 1836, Mr. Baldwin patented an invention of grates that were detachable and could be applied with a load of fresh coals at any point where the

engine was stopped over a pit, thereby avoiding the delay due to cleaning fires. This convenience never was called into service. As early as 1838 the use of iron flues was introduced and a few years later Mr. Baldwin invented the copper ferrule, which did so much to stop the annoyance of leaky flues. When the demand for coal-burning locomotives began to arise, rocking grates were introduced connected to levers which could be operated from the footplate. In 1850 the Bury form of boiler, which had been so successfully used and was a familiar feature of the Baldwin engines, was abandoned and the wagon top fire box took its place to remain the favorite of to-day. This form of boiler was first introduced in the Rogers Locomotive Works.

### Smoke Preventing Devices.

Among the experiments tried to promote smoke prevention was the placing of sheet iron deflectors in front of the fire door which soon burned out. A water-leg was proposed, but was abandoned in favor of a brick arch. Cross-flues were tried in the fire box to increase the heating surface and to act as a spark deflector, but they gave so much annoyance from leakage and bursting that they were soon abandoned.

The result of much experience with special appliances for helping to burn soft coal successfully convinced Mr. Baldwin that no special appliances would work so well as a skilful fireman aided by a brick arch.

### Steel in Favor at Baldwin's.

As a material for locomotive building, steel was early favored in the-Baldwin Locomotive Works. As early as 1848 steel axles were introduced and always were popular, although the high price of the material sometimes prevented railroad companies from paying for them. It was not till 1862 that steel tires first came into use, having been specified on some engines for Brazil. The general adoption of steel tires by American railroads followed slowly. Mr. Baldwin encouraged their demand by importing a large number of steel tires and keeping them in stock.

Steel fire boxes had been tried by the Pennsylvania Railroad in 1861, but it was English steel, too hard for the purpose, and was a failure. American homogeneous cast steel was then tried and proved successful, although it took many years to overcome the prejudice of railroad master mechanics in favor of iron for fire-boxes. Copper fire-boxes went out of favor with the introduction

of coal as fuel. The general introduction of steel for boilers proceeded slowly and was hardly completed when the twentieth century began.

#### Various Improvements.

Among the notable improvements introduced by Mr. Baldwin was metallic stuffing box packing, ground steam joints, interchangeability of parts, which was begun in 1838, making frames and pedestals in one piece, 1840; classifying the engines, 1847; slotting top of journal bearings, done first in 1852 by Charles Whiting, master mechanic of the Central Railroad of Georgia; various forms of feed-water heaters, various forms of spark arresters, variable exhaust nozzles, the Bissell pony truck, half saddle cylinders, templates and gauges and other minor manifestations of progress.

Mr. Baldwin died in 1866 and left one of the noblest industrial heritages ever built by the enlightened enterprise of one man. His successors have maintained the high reputation gained by the Baldwin Locomotive Works and made the establishment the greatest in the world.

# Sellers and Other Philadelphia Pioneers

---

## CHAPTER X.

---

### The Sellers Locomotives.

Those familiar with the history of early locomotives in the United States are aware that the Philadelphia & Columbia Railroad had two locomotives built by Coleman Sellers & Sons, but very little is popularly known about the engines, although they



Coleman Sellers

possessed features of design which ought to have made them famous.

Coleman Sellers was the descendant of a family that had come from Derbyshire, England, with a party brought out by William Penn. They were a race of natural mechanics, and the Sellers of America have inherited in full measure the mechanical skill of their ancestors.

### Coleman Sellers & Sons.

Coleman Sellers had four sons, of whom the two elder, Charles and George Escol, with him constituted the firm. Coleman Sellers, Jr., the youngest son, is alive and in good health in this year of December, 1906, and is one of the most celebrated mechanical engineers in the world. In 1834 the senior died and the brothers continued to carry on the business at Cardington, close to Philadelphia. In a series of engineering reminiscences contributed by



George Escol Sellers

George Escol Sellers to the *American Machinist* in 1885, he gives the following particulars about the building of their locomotives:

#### Big Pioneer Machine Tools.

"In the year 1834 the foundry and machine shop then carried on by my brother and myself were mostly engaged on work for iron furnaces, rolling mills, flour mills and machinery for paper making. To turn the dry cylinders for the latter we constructed what at that time was considered a mammoth engine lathe that

would turn 9 feet in length and 4 feet 10 inches diameter. Also for finishing the housings for paper-press rolls and calenders, we had built and put in operation the first iron planing machine in the State of Pennsylvania. If I recollect right there were only two others in the United States, one at West Point, N. Y., shops and the other at Dr. Nott's Novelty Works. This primitive machine had a capacity for 8 feet length by 4 feet wide and 3 feet high.

"In the latter part of the summer of 1834, James Cameron, brother of the Hon. Simon Cameron, at that time chairman of the Board of Canal Commissioners, called on us and said that he



Charles Sellers

had been informed by John Brandt that we had the above described lathe and planer, both well adapted for locomotive work, and asked if we would undertake the building of some locomotives for the State railroad. As the paper machinery and other work was slack, we took the subject under consideration and a few days later I accompanied Mr. Cameron to the Parkesburg shops to see and consult with their engineer and with Mr. Brandt, foreman of the shops. . . .

### Undertake to Build Locomotives.

"The result of the trip was that we undertook to build some engines for the State road, the commissioners stipulating that the boilers should be dome boilers, one pair of drivers back of the fire box and cylinders outside of the smoke box, drawings to be made and submitted to their approval. Brandt was very pressing that we should undertake to build these engines. He proposed while making the drawings to give me the advantage of what experience he had with the English locomotives, with the Baldwin



Dr. Coleman Sellers

Pioneer Locomotive Builder Was Superintendent of Niles Locomotive Works, Cincinnati

engine, and with one of Norris' that was having some changes made on it.

"Before commencing the drawings I had several discussions with Brandt, and while making them he several times came down to the city and remained over night with me. It soon became evident that requiring the driving wheels to be placed back of the fire box was more due to Mr. Brandt's opposition to full cranks in front of the fire box with the cylinders, valves and their con-



nections under the smoke box, than that urged by the commissioners of unequal distribution of weight and its injurious effect on the rails.

### Against Full Cranks.

"It was also evident that full cranks could not be placed back of the fire box and the cylinders outside of the smoke box without reducing the diameter of the boiler and narrowing the fire box to an extent that was not admissible.

"I proposed outside connections, but that would not be listened to. The Baldwin half crank must be adopted, but this we refused without written consent from Mr. Baldwin, which Mr. Cameron undertook to secure, saying he would pay a reasonable consideration for its use. Mr. Cameron returned saying that Mr. Baldwin had applied for a patent on the half crank; that he had made the invention for his own protection and it was not for sale on any terms.

### Outside Cylinders Proposed.

"In this dilemma I again unsuccessfully urged outside connections. I proposed to equalize the weight by another pair of drivers back of the fire box connected by outside cranks in the manner of the English four-wheel engines, the front pair of drivers having full crank axle. I made a sketch of this which met with Mr. Cameron's approval, but Mr. Brandt would not give way in his objection to the cylinders with steam connections under the smoke box, he had so much trouble with English engines. He finally joined me in advocating outside connections. Mr. Cameron said the commissioners were not willing to risk experiments. I urged that outside connections was no experiment, that Stephenson's Rocket, Hackworth's Sanspareil, in fact, most of the early English locomotives were outside connected. . . .

"We offered to build either as I had suggested with full cranks and two pairs of drivers or outside connections and one pair of drivers back of the fire box, but it was not until we guaranteed against injurious oscillation that the latter plan was accepted. . . .

"I made the drawings and submitted them, thinking everything would be satisfactory, but I was mistaken. My drawings called for iron frames instead of wood, that up to that time was the only frame in use. It was objected to on the ground of its having too much rigidity. After considerable argument and delay, the iron frame was approved of."

### Originality in Design of the Engines.

After a great many trifling objections had been raised and overcome the engines were eventually built. They had outside cylinders with a single pair of drivers behind the fire box and a four-wheel truck with a center bearing. The frames were iron and the driving wheels had counterbalance weights bolted opposite the crank. Mr. Rogers, of Paterson, visited the shop when the engines were under construction and expressed approval of the counterbalance weights, but thought they ought to have been cast in the wheel center.

The engines gave much satisfaction in service, and the four



Joseph Harrison

novelties of design, the outside cylinders, the iron frames, the counterbalanced driving wheels and the center bearing truck, were all gradually adopted by American locomotive builders, but I am not aware of the credit of these improvements ever having been given to those who originated them. The engines possessed all the elements of what afterwards became the representative "American locomotive," except the second pair of drivers, and that arrangement the builders had proposed.

### Garrett & Eastwick Begin Locomotive Building.

There were soon going to be plenty of competition in the business of locomotive building. In 1835, the year after Mr. Bald-

win entered seriously into the work of locomotive building, the firm of Garrett & Eastwick, then making steam engines and light machinery, in Philadelphia, obtained an order to build a locomotive for the Beaver Meadow Railroad, the first section of what is now a branch of the Lehigh Valley Railroad.

### The Beaver Meadow Railroad.

The Beaver Meadow Railroad winded about the mountains and forests of the Mauch Chunk region of Pennsylvania, and was originally built for the transportation of coal for shipment on the Lehigh Canal. The construction of the line was a great enterprise as it involved the overcoming of greater engineering difficul-

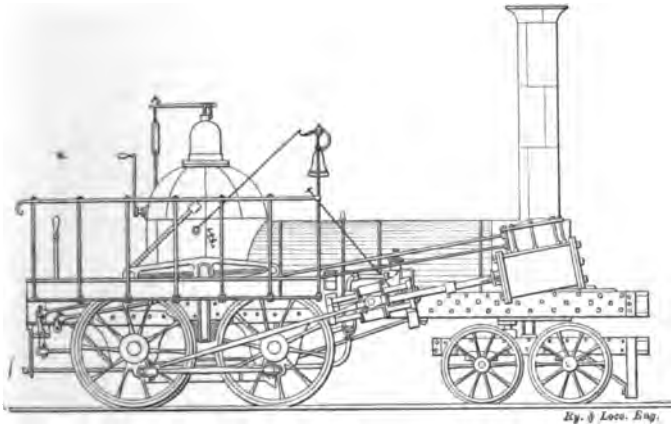

Fig. 73. Garrett & Eastwick's Locomotive Hercules

ties than anything previously encountered in railroad construction. When finished the road was exceedingly crooked and hilly. It had one curve 300 feet long of 250 feet radius; there were two grades 96 feet to the mile, three-quarters of a mile each, and one grade 80 feet to the mile, five miles long, having several curves, one of them being 550 feet radius.

The capitalists who undertook the construction of that railroad were leaders among the most enterprising gentlemen in Pennsylvania at that time. They spared no expense to make the railroad and its equipment equal to the best that could be procured at that period.

### Eastwick & Harrison's First Engine.

The Beaver Meadow locomotive was called the "Samuel D. Ingham," after the president of the road. The engine had the Bury boiler and inside frames with outside cylinders, the latter arrangement having up to that time found very little favor from locomotive designers. The reversing gear invented by Andrew M. Eastwick was entirely original, and consisted principally of a sliding block intervening between the valve seat and the slide valve in such a way that it acted as a reversing gear. This in-

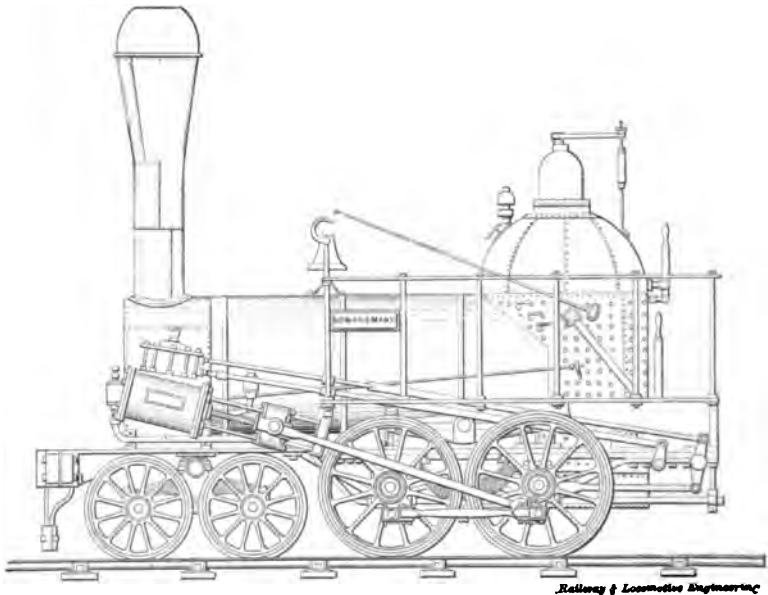

Fig. 74. Gowan & Marx

*Railways & Locomotive Engineering*

vention is illustrated and described in the chapter on Valve Motion.

### Joseph Harrison, Jr.

As Garrett & Eastwick had no experience in locomotive building, they engaged as foreman, Joseph Harrison, Jr., a young man who had worked for several years in the Norris Works, where he learned a great deal from the failures and a little from the successes in locomotive building. Harrison developed into an excellent designer of locomotives, and he invented a variety of improvements which became permanent features of the locomotive engine.

### The First Cab.

The "Samuel D. Ingham" compared favorably with any locomotives then in use. The engine was noteworthy as being the first built with the deck covered to afford protection of the engine-men. It is said to have been a very crude cab, but it was a beginning of a very desirable improvement, that was soon acknowledged to be an absolute necessity for locomotives operating in the rigorous climate of the United States.

### The First Eight-Wheel Engine.

Early in 1836, Henry R. Campbell, a civil engineer on the Philadelphia & Germantown Railroad, secured a patent on an eight-

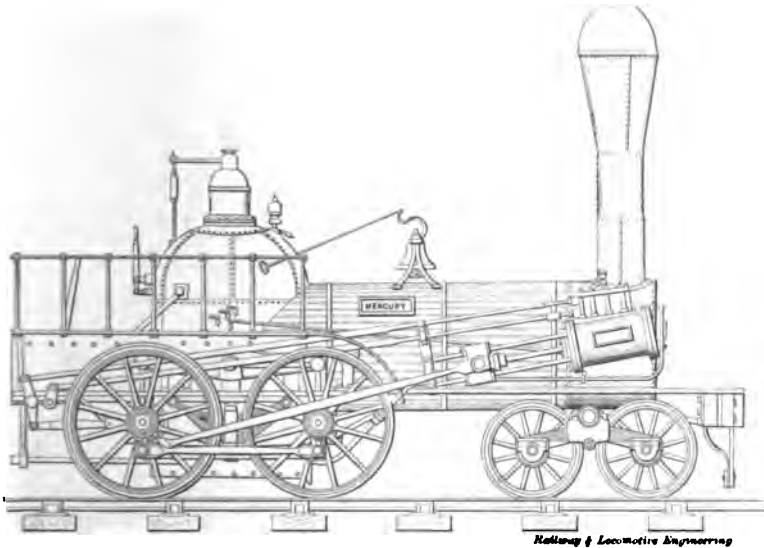

Fig. 75. Mercury

wheel engine, Fig. 70, with one pair of driving wheels in front of the fire-box and the other pair behind. It was the first of what afterwards became known as the American Locomotive, the pattern of which was copied more or less by all the railroads of the world.

In designing his engine, Campbell was influenced by the desire to produce a locomotive that would be easy on the tender track. Strap rails laid on wooden stringers were still the rule, and the Beaver Meadow road, recently opened, was considered particularly substantial with strap rails,  $2\frac{1}{2} \times \frac{3}{8}$  inch, laid on substantial pine stringers.

### Why Fragile Railways Were Built.

The tendency towards the building of light railroads was due more to the poverty of the country than to want of foresight on the part of our railroad builders. The native furnaces could not produce but a small fraction of the iron needed for rails, and the import duty was about \$25 a ton. As the building of a railroad provided with substantial rails was out of the question, the pioneer builders did their best with the material at their command.

One engine was built after Campbell's drawings in a shop in Philadelphia belonging to James Brooks & Co., and it was put to work on the Philadelphia & Germantown Railroad, but did not become popular. The principal objection to it was that it rode

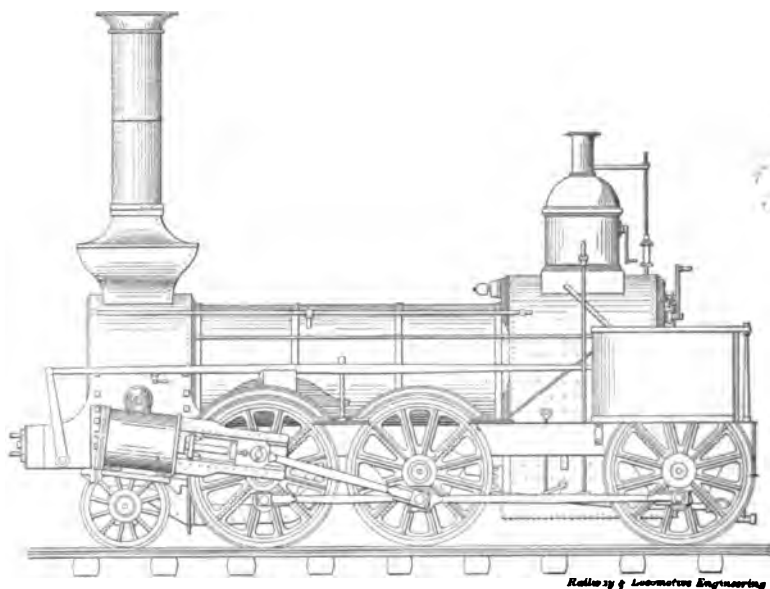

Fig. 76. First Mogul Ever Built. Made by Eastwick & Harrison, for Russia

hard, due to the want of means for equalizing the weight on drivers.

### Garrett & Eastwick's Hercules.

Late in 1836 the firm of Garrett & Eastwick built an eight-wheeler called "Hercules" (Fig. 73), for the Beaver Meadow Railroad, in which an attempt was made to render the engine more flexible. Mr. Eastwick devised a separate frame with pedestals, in which the two pairs of wheels were placed. This frame vibrated

upon the center bearing, and could move as the truck does, except that it could not turn. This allowed it to adjust itself to uneven track, provided the unevenness was alike on both sides, otherwise it racked the framing. This frame was underneath, and separated from the main frame by side bearing springs. This was better than the old rigid plan of Campbell's, but not very much better. This engine "Hercules" was the first one to have bolted straps and half-boxes on the side rods, instead of a gib and key; the rods had no keys.

The "Hercules" weighed fifteen tons, and was to run on a very crooked and hilly road. This engine was so flexible that it could accomplish more work than the others in use, and more

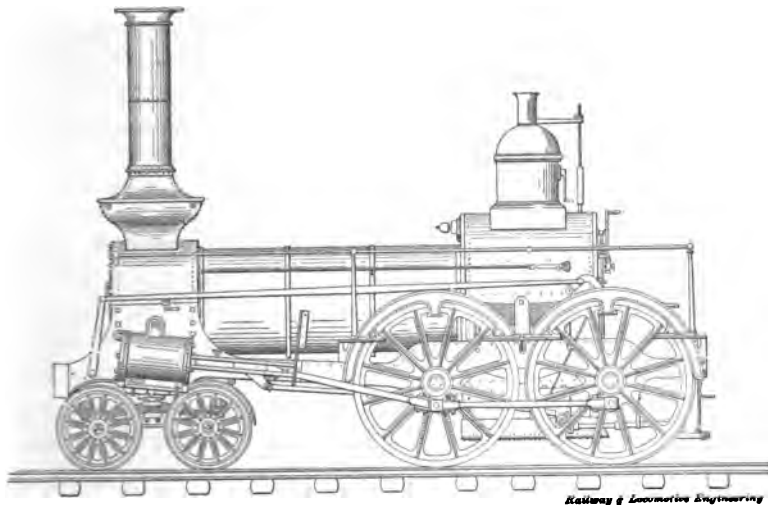

Fig. 77. Eight-Wheeler Built by Eastwick & Harrison

like it were ordered. But in the meantime, the firm took into partnership Joseph Harrison, Jr., their young foreman, who set about simplifying the flexible engine; and the result was the invention of the modern equalizer, now universally used in this country and in most foreign countries.

### The First Equalizers.

Harrison's first equalizers were made of cast iron, very heavy and clumsy, and were hung above the frame just as they are now in eight-wheelers, the ends bearing on round pins that went down and rested on the top of the box. Mr. Harrison's patent covered all the combinations of equalizers now known, and also provided

one for the truck. This device made it possible to use any number of driving wheels on the roughest track, and was, up to that time, the most useful improvement made on the locomotive engine.

### Equalizers Discredited.

The other builders condemned the use of more than one pair of driving wheels, and did not, for some time, credit the equalizer with any merit. Mr. Baldwin said he could not see how the engine would curve without slipping some of the drivers, and he thought it impossible to maintain all four wheels exactly the same size and thought them complicated; but their good points were forced upon him by their service, and, in 1845, he bought the patent of Mr. Campbell's eight-wheeler, and that of the equalizer of Eastwick & Harrison, and at once turned out his first class "C" engine, and afterwards said she was the best engine he had then turned out.

### The "Gowan & Marx."

In 1839, Eastwick & Harrison, as the firm was now called, received an order from the Philadelphia & Reading Railroad for a big locomotive to weigh all of eleven tons, not less than nine tons to be on the four drivers, and it was specified that the engine must burn anthracite coal in a horizontal boiler. The engine built upon this order was known as the "Gowan & Marx" (Fig. 74), which became one of the most famous locomotives ever built.

The engine was of the eight-wheel type, and in order to properly distribute the weight, the rear axle was placed under the fire-box, just as it is now placed under six and eight coupled engines. The boiler had a Bury dome fire-box 5 feet diameter. Two-inch tubes 9 feet long nearly filled the cylindrical part of the boiler.

The cylinders was  $12\frac{1}{2} \times 18$  inches, and the driving wheels were 42 inches diameter. A blower for stimulating the fire was first used on this engine, and it was the first to be equipped with Harrison's equalizers.

When put in service the "Gowan & Marx" developed such extraordinary tractive power that the whole railroad world became interested and many individuals were incredulous. On one of its first trips in February, 1840, it hauled from Reading to Philadelphia a train of 104 four-wheel loaded cars, at an average speed of 9.82 miles per hour. The road had a descending gradient of nearly 4 feet per mile, 27 miles level, 9 miles of it in one place, and only one ascending grade, 26.4 per mile for 2,100 feet. This train



weighed 423 tons, and, including the weight of engine and tender, equalled *forty* times the weight of the engine.

In connection with the great amount of tractive power developed by the "Gowan & Marx," in proportion to its weight, it is curious to note that only ten years earlier, the Liverpool & Manchester Railway Company, in offering a prize of five hundred pounds for a practicable locomotive, required that it should pull *three* times its own weight. The South Carolina Railroad Company, in ordering a locomotive from the West Point Foundry, in 1830, also specified that it must pull a train three times the weight of the engine.

The success of the "Gowan & Marx" promised to promote rapidly the business of the builders, but the personal good fortune brought to the firm deprived the United States of good locomotive manufacturers.

The remarkable performances of the engine attracted much attention at home and abroad. The Russian Government, on account of the work done by this engine, sent two engineers to the United States to verify the account and to report on the best machinery and appliances for the St. Petersburg and Moscow Railway, then under construction.

The report of these engines was so favorable that Eastwick & Harrison were requested to visit St. Petersburg, with the view of making a contract for building locomotives and cars. The contract was made and the Americans established locomotive building works in Russia and shortly afterwards closed up their works in Philadelphia.

Before closing their works for good, Eastwick & Harrison built two passenger engines for the Baltimore & Ohio, which were as notable for fast speed as the "Gowan & Marx" was for load pulling. One of these, the "Mercury" (Fig. 75), in 1844 worked the great aggregate of 37,000 miles, the greatest annual mileage achieved by one engine up to that time.

# First Links of the New York Central Railroad

## CHAPTER XI.

### Prosperity Promoted Railroad Enterprises.

The beneficent administration of John Quincy Adams, which ended in 1829, left the country so prosperous that there was unusual surplus capital to invest in industrial enterprises. The operation of railroads promised to be so profitable that capital was readily secured for the building of new lines. In some States excitement in favor of railroad building became vigorously active about 1830, and continued till the inevitable panic of a few years later converted the golden day dreams of many investors in railroad securities into hideous nightmares of ruin.

### Numerous Short Railroads Chartered.

During 1830 many charters were granted for the construction of railroads, and considerable work was done on short sections that now belong to great railroad systems and are boasted about just as families boast about the antiquity of their ancestors, who often in the flesh were very inferior creatures.

In 1831 seven miles of the Baltimore & Susquehanna Railroad were finished, and an English engine, the "Herald," was imported to operate it. This engine has a historical association, since Ross Winans applied four small leading wheels to it, about the time that John B. Jervis applied the four-wheel truck in front of an engine belonging to the Mohawk & Hudson. The purpose of both inventions was the same, but the means employed was different, yet a fierce controversy arose about who was the originator of the leading truck, which afterwards became so popular. The world has decided that the credit of inventing the 4-wheel leading truck belongs to Jervis.

The Baltimore & Susquehanna was subsequently absorbed by the Northern Central Railroad, which in its turn was swallowed by the Pennsylvania Railroad Company. It is usual to say that the Camden & Amboy was the first link built of the Pennsylvania

system, but the Baltimore & Susquehanna clearly antedates the other.

Other railroads that had some miles put into operation during 1831 were the Camden & Amboy, in New Jersey; the New Castle & Frenchtown, in Delaware; the Mine Hill & Schuylkill Haven, the Mount Carbon in Pennsylvania, and a few others that began nowhere and ended in a similar locality. A few miles of mine tramways were also opened, all showing that the idea of moving heavy freight on rails was appealing favorably to the American people.

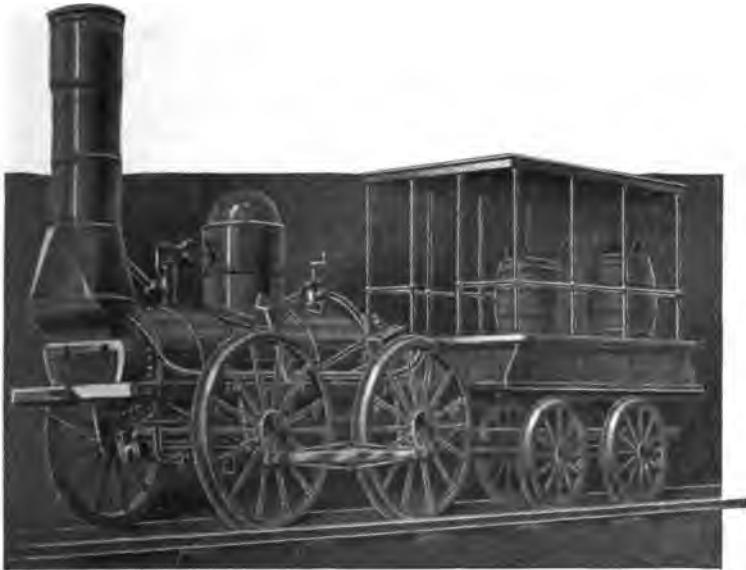

Fig. 78. DeWitt Clinton

### The Mohawk & Hudson Railroad.

After the South Carolina Railroad, next one to come into prominence was the Mohawk & Hudson Railroad. This company was chartered in 1826, but construction was not commenced until 1830. It was opened with ostentatious ceremonies in 1831.

Readers of railroad development often wonder why one of the most celebrated pioneer railroads in the United States should have been built away inland, to connect two comparatively small towns, while the great city of New York had done nothing to promote such enterprises. The fact is that in 1830, the city of Albany, the capital of New York State, was relatively a much

more important place than it is to-day, and Schenectady was an ancient growing city that expected to advance rapidly into metropolitan dimensions. Albany was at that time the seventh city in the Union, was the seat of the State Legislature, of the law courts, the principal entrepôt for the farm produce brought in from the fertile valleys extending to Lake Erie, and was the immediate landing place for all the products of the uberous Mohawk Valley.

### Inducements to Build the Railroad.

The movement of population toward the forests and prairies west of Lake Erie had hardly begun, for there was less than five thousand people settled west of the lakes; but farseeing men perceived that the immense vacant spaces would be filled before many years passed, and it was seen that the route of the Erie Canal would be the channel of western emigration. Railroads, built along this route, were certain to take much of the business of transporting passengers away from the tedious canal which was prostrated by frost a considerable part of the year. So the enterprise of building the Mohawk & Hudson Railroad was a sensible undertaking and received all the financial support required.

The line was only about seventeen miles long, but natural obstacles had to be overcome of greater magnitude than those undertaken by most of the pioneer railroad engineers. John B. Jervis, who had become celebrated for achievements in canal construction, and who sent Horatio Allen to England to study railroad problems, was chief engineer, and he had few equals in the world at the time.

The old city of Albany was built on river bottoms, that had been washed out of the adjoining high lands which form an elevated plateau extending many miles south and west. This plateau had to be traversed by a line going to Schenectady. As the pioneer engineers supposed that a locomotive engine could climb only very light gradients, inclined planes were employed to raise the cars at Albany, and to lower them to another low level at Schenectady. The top of the inclined at Albany was near the point where the imposing State House now stands.

### The "De Witt Clinton."

Early in August, 1831, the Mohawk & Hudson Railroad was ready for operating, and on the 9th of that month an excursion

train was run over the line from Albany to Schenectady drawn by the locomotive "De Witt Clinton," built at West Point Foundry, New York City, from designs furnished by John B. Jervis, engineer of the railroad company. The appearance of this engine, shown in Fig. 78, is well known, owing to the numerous pictures of it which have been published.

The "De Witt Clinton" was a four-wheel engine, all drivers four and a half feet diameter, with cast-iron hubs, spokes turned and polished and wrought iron tires. There were two cylinders,  $5\frac{1}{2} \times 16$  inches, set at the sides of the fire box at an angle of about 30 degrees. They transmitted the power to inside cranked



Fig. 79. Jervis Truck Engine

axes on the first pair of wheels. The wheels were connected outside by side rods in the form of double trusses.

The most conspicuous thing about the engine was the boiler, which was horizontal, and had a huge dome that overshadowed the rest of the engine. The boiler had thirty copper tubes  $2\frac{1}{2}$  inches diameter and six feet long, and was fed by pumps operated vertically by a bell crank. The fire box had two doors, one above the other. The steam carried was 50 pounds to the square inch. When the boiler was filled with water and the fire box charged with wood, the whole thing weighed about four tons. When in good working order it was found that the engine would haul five of the small cars then used on a level at a speed of about thirty miles an hour.

### Ceremonial Inauguration of Railroads.

In the year of grace 1831, the American people were beginning to be proud of the achievements in railroad building accomplished by native enterprise and ability, but this feeling had been little manifested publicly. There had been one exception in a public demonstration made in connection with laying the cornerstone of the Baltimore & Ohio Railroad. That had been attended by one of the most magnificent processions of the military and civil associations, trades and professions ever witnessed in the United States. The venerable Charles Carroll, of Carrollton, then over ninety years of age, the only survivor of those who signed the Declaration of Independence, was present, and laid the cornerstone amidst impressive ceremonies. The ceremony of driving the first spike had not yet been inaugurated.

Since that day railroad builders had been contented to begin their work and to inaugurate the operating of their properties in a less ostentatious fashion. But when the opening day of the Mohawk & Hudson was approaching, a movement was instituted to give the enterprise an initiation worthy of the first railroad connecting the capital of the Empire State with the outside world.

The year before, the Liverpool & Manchester had been opened with impressive ceremonies, in which the Duke of Wellington, the hero of Waterloo, and other celebrities took a part. The festivities of the occasion had been clouded by a locomotive running over a member of Parliament with fatal results; but that did not deter the promoters of the Mohawk & Hudson Railroad from arranging for an opening excursion in which the leading celebrities of New York State were invited to ride.

### Demand for a Gala Day Opening.

There were many legislators, judges and other public officials in Albany at the time, and they readily accepted the invitation to take a free ride, a practice the politicians of all States have faithfully adhered to ever since. A formidable array of names of men who took part in that excursion is preserved; but time has robbed most of them of the importance they originally possessed.

On August 9, 1831, the "De Witt Clinton" stood on the newly finished track at the top of the inclined plane at Albany with a train of highly picturesque cars behind her. They were large stage-coaches with doors at the sides, and to convert them

to railroad use the bodies were secured to oblong wooden frames to which the axle boxes were fitted. The ends of the frames acted as bumpers and the cars were coupled together by loose chains. They carried passengers inside and on top.

The original intention had been to use a Stephenson engine imported a short time previous, to pull the first train on the Mohawk & Hudson, but something was the matter with that engine and the "De Witt Clinton" was selected at the eleventh hour.

Philip Hone, who was at that time president of the Delaware & Hudson Canal Company, wrote in his diary:

"Albany, September 24, 1831. Opening of the Albany & Schenectady Railroad.

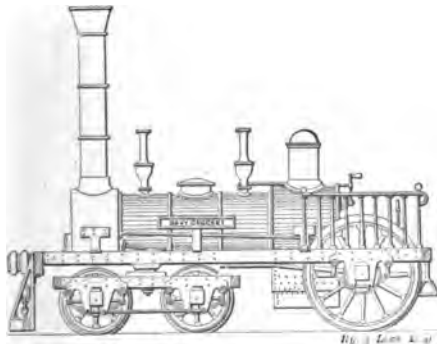

Fig. 80. Davy Crockett

"After breakfast I joined a large party at the Eagle Tavern, and we proceeded in carriages under the orders of Mr. Cambreling, the Superintendent, to the starting place of the railroad, about two miles from the city. The road from this point is finished a distance of nearly  $12 \frac{1}{2}$  miles. The inclined planes at each end of the road were unfinished. The whole length of the road when completed will be  $15 \frac{3}{4}$  miles. We experienced a detention of nearly two hours, owing to one of the locomotive engines, an English one, being out of order. It was finally abandoned, and we started with an American engine, made at the West Point Works, which performed admirably."

#### The First Train An Excursion.

When the engine was getting up steam, passengers were crowding into the cars until they were nearly as well filled as an

elevated railroad car during the rush hours. David Matthew, the engineer, dropped oil on the frictional surfaces, examined carefully every rod and bearing, then mounted the unprotected foot-plate ready to start. John T. Clark, who was the first conductor, mounted to the seat at the back of the tender, tooted upon a tin horn, and this famous cavalcade started. So did the horses belonging to a concourse of farmers who had come in their buggies and wagons with their wives, families, cousins and aunts. No resounding automobile ever spread such consternation around. When the engine gave forth the first exhaust the horses started away in frightful terror.

A gentleman who was in the train afterward wrote: "A gen-

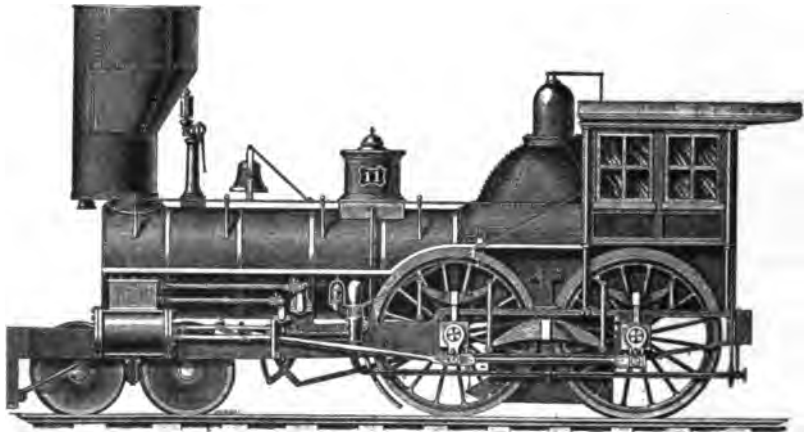

Fig. 81. Designed and Built by David Matthews for Mohawk & Hudson Railroad about 1840. Rebuilt about 1855

eral notice having been given of the contemplated trip, excited not only the curiosity of those living along the line of the road, but those living remote from it, causing a large collection of people at all the intersecting roads along the line of the route. Everybody, together with his wife and all his children, came from a distance with all kinds of conveyances, being as ignorant of what was coming as their horses, drove up to the road as near as they could get, only looking for the best position to get a view of the train. As it approached, the horses took fright and wheeled, upsetting buggies, carriages and wagons, and leaving for parts unknown to the passengers, if not to their owners, and it is not now positively known if some of them have yet stopped." gle



### On the Train.

The passengers on the train had their own share of excitement when the engine started, the loose couplings jerked the train so violently that the passengers were thrown into confused heaps, clinging desperately to each other to avoid falling off.

The original intention was to burn anthracite in the fire box of the engine, but a few experimental runs had proven that anthracite would not generate steam fast enough, so it was determined to burn pitch pine. There was no spark arrester, so the force of the exhaust threw out a volume of black smoke freely mixed with sparks, coal, cinders and lumps of half-burned pine. The sparks found their way into the eyes and ears of the passengers, down their necks and into every crevice in their clothing. Those who carried umbrellas raised them to ward off the fiery downpour; but these soon took fire, and the train held a frantic crowd, who slapped out the flames, destroying their own and their neighbors' garments. People by the wayside supposed that the train was carrying a load of maniacs. Consternation reigned supreme, and many people thought of jumping before the engineer perceived the condition of affairs. By that time they were near a water tank, where a stop was made, and the burning garments were drenched with water. Many of the pleasure seekers had painful reasons to remember their first ride on a railroad train.

### Locomotive Robert Fulton.

As the only public locomotive building works in America at this time was the West Point Foundry, New York, which was of very limited capacity, most of the railroad companies had to order locomotives from England, principally from the works of Robert Stephenson & Co., Newcastle, and of Edmund Bury & Co., Liverpool.

Shortly after the Mohawk & Hudson Railroad was opened for business, a locomotive called the "Robert Fulton," was received from England. This engine was a modification of what was known as the "Planet" class, the most successful type of engine built by the Stephensons up to this time. The Planet class proper had inside cylinders placed under the smoke box, cranked axle, of course, one pair of drivers set in front of the fire box and one pair of small carrying wheels behind the smoke box. Fig. 15, page 32. Instead of the small carrying wheels, the Robert

Fulton had a second pair of drivers, and the wheels were connected the same as the De Witt Clinton. The wheels were four feet diameter, set four and one-half feet apart from center to center. The total weight of the engine in working order was about 15,000 pounds.

The Robert Fulton was the same type of an engine as the "John Bull" received by the Camden & Amboy Railroad about the same time as the Robert Fulton arrived. That type was afterwards called the Samson class by the makers.

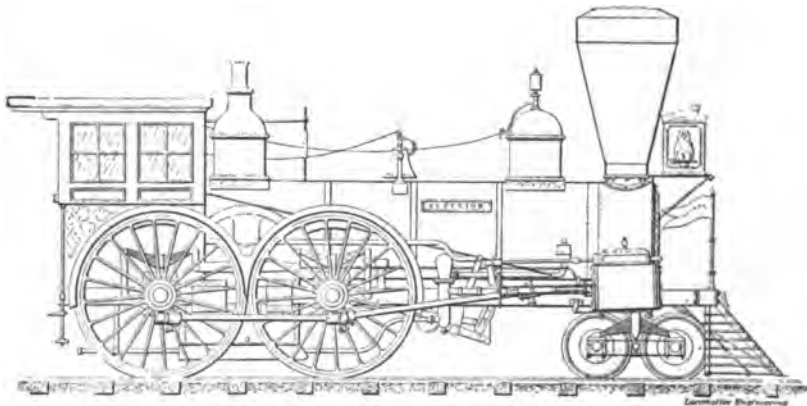

Fig. 82. Hudson River Railroad Breeze & Kneeland Engine. Built in 1853  
Cylinders 16 x 22 inches, Drivers 7 feet diameter

### Defects of the Robert Fulton.

The engine steamed well and had all the tractive power required, but defects developed which led to the invention of the engine truck. The frame was twelve feet long and the axles being four and a half feet apart, it projected beyond the bearing on the axles over three feet each way. This produced an unsteady motion that was very unfavorable to the track, the machinery, and disagreeable to the engineman. It teetered like a short wheel-base horse car. The track of the Mohawk & Hudson was well constructed for that time, being of strap iron laid on southern pine, but the hammering action of the Robert Fulton was too much for it.

### Invention of the Engine Truck.

Mr. Jervis admitted that heavy engines must come into use, and he got cogitating over means to prevent the destructive ef-

fects of the Robert Fulton. This led him to propose a four-wheel leading truck. He made drawings for an engine having this improvement and sent them to the West Point Foundry. The engine made from the drawings, which was called the "Brother Jonathan," Fig. 79, was delivered in 1832, and worked so well that the English engine was changed, the forward pair of drivers being removed and the four-wheeled truck put in front.

Nearly all writers on American pioneer locomotives call Jervis' first truck engine the "Experiment," but in his own book on "Railway Property" Jervis explains his purpose in making the design and calls the engine the "Brother Jonathan."

David Matthew, who had charge of the building of the Brother Jonathan, wrote about the engine: "She had cylinders  $9\ 1/2 \times 16$  inches, two driving wheels five feet diameter, set aft furnace. Truck wheels 33 inches diameter. The truck worked upon friction rollers. The furnace was five feet long and 34 inches wide, made to burn anthracite coal.

"With this engine I have crossed the Mohawk & Hudson from plane to plane fourteen miles in thirteen minutes, making one stop for water."

This will show that claims of high speed began early on the New York Central.

### Jervis Orders Stephenson Engine with Leading Truck.

That same year Mr. Jervis sent to Robert Stephenson & Co. drawings and specifications for a locomotive to be built for the Saratoga & Schenectady Railroad. It had a single pair of driving wheels and a four-wheel truck (Fig. 80 was called the Davy Crockett), and this was the first locomotive built in Europe with a truck which they call a "bogie," then the slang name given to small four-wheel service cars. The word is now good English, but it was not admitted into dictionaries in the third decade of last century.

The weak and fragile condition of the track of early American railroads made the leading truck popular wherever it was tried, and it came rapidly into favor. Baldwin used it in his second engine and continued its use, so did the Norris's and other early locomotive builders. It was the most valuable improvement which the New York Central Railroad System bestowed upon the railroad world.

The Mohawk & Hudson Railroad is now little more than a

memory, but it had the proud distinction of being the first railroad operated in the Empire State and it was the seed from which grew the

### New York Central Railroad.

A brief history of the pioneer railroads that made the New York Central Railroad, taken from various sources, is likely to be of interest: The Mohawk & Hudson was opened for traffic in 1831 and was operated to some extent by inclined planes. During the sixteen years immediately ensuing, the experience in railroad construction found many problems which had puzzled the pioneers in steam transportation, and the necessity for hav-

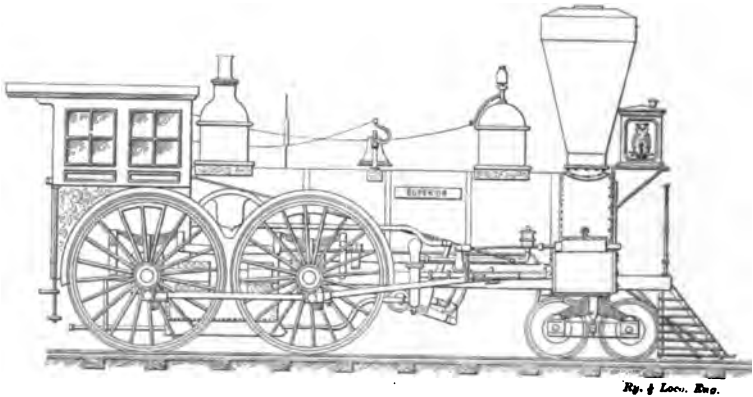

Fig. 83 Built in 1854, by Breeze, Kneeland & Co., Jersey City, N. J., for Hudson River Railroad. Cylinders, 16 x 22 inches; Wrought Iron Driving Wheels, 78 inches diameter

ing a road that could be operated by locomotives as the sole power was generally recognized. In 1847 a charter was obtained for the Albany & Schenectady Railroad Company, which became possessed of the franchises of the Mohawk & Hudson Railroad. The new company altered the grades to meet the requirements of the age.

The next railroad in chronological order was the Utica & Schenectady Railroad, chartered in 1833. Within three years thereafter the road was built from Schenectady to Utica, seventy-eight miles.

Third came the Auburn & Syracuse Railroad, chartered in 1834. This road, 26 miles long, was not ready for business until 1843.

Fourth line in the chain was the Syracuse & Utica Railroad, chartered in 1836 and opened for business in 1839.

Fifth was the Tonawanda, and Attica & Buffalo Railroads which made connection with the lake end. The first was chartered in 1832, the latter in 1836. They were consolidated in 1850 as the Buffalo & Rochester Railroad.

The sixth link was closing the opening between Syracuse and Rochester, which was done by the Auburn & Rochester Railroad. The direct railway between Syracuse and Rochester was constructed by the Syracuse & Rochester Railroad Company, incorporated in 1848.

The most important link that eventually took hold of all the others, forming them into a strong continuous chain, was the Hudson River Railroad Company. This company was incorporated by special charter in 1846 to build a railroad from East Albany to New York, an estimated distance of 144 miles. It took five years to

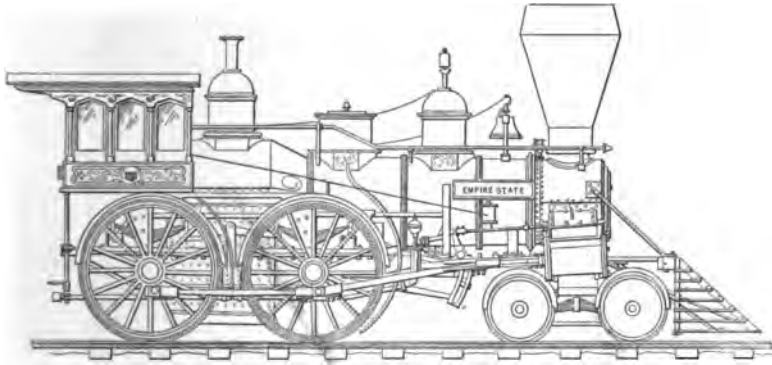

Fig. 84

make the connection between New York and East Albany. It had rather a feeble existence until 1864, when Commodore Vanderbilt secured control. His genius for organization laid the foundation for the prosperity that gradually came to the property.

From a mechanical standpoint the New York Central lines followed a very conservative policy and the history of motive power development represented all the railroads in the country where there were no heavy grades to be operated or heavy mineral traffic to be handled.

They began with the De Witt Clinton, which was followed by small engines having the Jervis truck and a single pair of drivers. Then came the small four-wheel connected engine with four-wheel truck (a good specimen being shown in Fig. 84) which was ad-  
 Google

ice until 1890 when mogul engines were introduced for freight service.

The line of enlargement is graphically seen in Figs. 83 and 84. The engine illustrated in Fig. 83 was built by Breeze & Kneeland in 1853 and was an ambitious attempt at the introduction of a high speed locomotive. The cylinders were 16x22 inches and the driving wheels 7 feet diameter.

The engine "Empire State," Fig. 84, was built in 1858 and has all the characteristics of the modern 8-wheel engine. The progress represented up to No. 870, Fig. 85, was principally in increasing the dimensions.



Fig. 85. Buchanan's Engine for Empire State Express

In 1891, William Buchanan, Superintendent of Motive Power of the New York Central Railroad, in co-operation with Albert J. Pilkin, General Manager of the Schenectady Locomotive Works, designed an express locomotive numbered 870, Fig. 85, which led the way in the race of powerful express engines since put in service. The cylinders were 19x24 inches, driver wheels 78 inches diameter, heating surface 1,851 square feet with 27.3 square feet of grate area.

Much more powerful passenger engines have since been introduced upon this road, but they came in the regular course of locomotive development and will be referred to in another chapter.

# First Railroad Construction in New England

## CHAPTER XII.

### New England Waits for State Aid.

Although one of the first railroads for the movement of wheeled vehicles used in the United States was constructed in New England, that section of the country was not so early to engage in



"The Site of the Birthplace of the American Railroad"

railway building as other parts having less commerce and less population than Boston and its spangled banner of manufacturing towns. The people of New England generally, and of Massachusetts in particular, were by no means backward in recognizing the advantages of good means of transportation, but they had grown to believe that the canal was the proper way to extend inland intercourse. As the construction of canals had come to be regarded as a State enterprise, railroad work was put into the same category, and the good people of Boston and its satellite towns, while wishing for railroad connection, waited for the State to do the work when much less important centers of population elsewhere were helping themselves by subscribing for stock in railroad companies.

### Public Sentiment Opposed Granting Charters.

Public sentiment in favor of giving charters to private individuals or corporations to build railroads was of slow growth in Massachusetts, for the democratic idea was long entertained that no public franchises should be given to private individuals or corporations. When, in 1826, Gridley Bryant applied to the Legislature for a charter to build a short tramway from the Quincy quarries to the Neponset River, vigorous opposition was encountered. Had it not been that patriotic sentiments were excited, because the stone



Remains of Railroad to Quincy Quarries

was to be used in building the Bunker Hill Monument, it is likely that the charter would have been refused.

### Quincy Quarries Railroad.

The Quincy Quarries Railroad proved to be a good object lesson for New England people, and convinced them that freight could be moved on rails more readily than on turnpike roads. It also taught them that seizing the right of way by eminent domain did not take away the palladium of the people's liberties, as they were assured would be the case by the opponents of the enterprise.



### To View the Remains of the Quincy Railroad.

Most Americans imbued with patriotism and love of country regard with warm interest the few traces that are preserved of the railroad which formed the genesis of the greatest system of inland transportation in the world to-day. As a guide to any person wishing to make a pilgrimage to the place where the Quincy Quarries road started I gladly publish the following article which was contributed by S. Harry Ferris to the Four Track News. I am indebted to Mr. George H. Daniels, of the New York Central Railroad, for one of the cuts illustrating this chapter:

The old Bay State is rich in spots that are hallowed by their association with the great events of the past. Boston, in particular, is a mecca toward which many thousands of historical pilgrims turn their footsteps every year. They patiently climb to the top of Bunker Hill monument, and stand in awed silence while they look out over the roofs of the city that has played such an important part in the drama of the nation's progress; they visit the ancient "Cradle of Liberty," and pay patriotic tribute to the glorious memories that cluster around the place; they search out the Old South Church, and linger with palpitating hearts upon the scene where Adams and Warren thundered their orations in behalf of liberty, and the participants in Boston's famous tea-party assembled, previous to proceeding to the harbor to brew the beverage that so disturbed the digestion of King George; they penetrate the squalid regions of the dark North End to gaze upon the belfry in which the signal lanterns of Paul Revere were hung; they block the roadway of busy State street while they cogitate above the square yard of pavement that covers the exact spot upon which the first blood of the Revolution was shed, and last, but not least, they reverently kneel while they silently revive the sacred memories of childhood at the foot of a little mound in the Old Granery Burying Ground, that covers all that is mortal of "Mother (Mary) Goose."

### Where American Railroads Were Born.

There is one historical spot near the old Puritan town, however, that has been largely neglected by historical pilgrims in the past.

That is the place where the American railroad was born.

Why it should have been thus neglected is, perhaps, difficult to say, unless it be that only comparatively few people are aware of its precise location. For, if it be a good investment of time to visit a place that is of interest because of the important part it has played in the nation's political and social history, surely it must be worth while to stand where a great industrial enterprise that has annihilated time and space, joined the Atlantic to the Pacific, built great cities and towns—in a word been the foremost factor of importance in making the country what it is—had its beginning.

To visit the birthplace of the American railroad the pilgrim in search of historical shrines should alight at a small station labeled "East Milton," half a dozen miles south of Boston.

Leaving the railroad station the visitor will walk down the



First American Railway (The "Granite Road")  
How Quincy Quarry Railroad Was Operated

track about half a mile in the direction of Boston; there he will suddenly come upon a large granite monument standing just at the edge of the roadbed.

### The Quincy Railroad Monument.

The somber granite slab seems very incongruous amid its surroundings. It produces the impression that it must have strayed from some quiet section of a nearby cemetery, but as the pilgrim draws near the stone and reads its inscription he becomes aware that it has been placed there to mark the site of the birthplace of the American railroad.

Bunker Hill Monument was about to be erected, and it was

determined that the granite for the mighty shaft should come from Quincy, Mass.; but how to get the great cubes of stone from the famous quarries to the scene of construction was a puzzling and difficult problem. To cart the material overland by horse power was an absolute impossibility.

About this time rumors of the success of railroad operation in England began to reach this country, and the owners of the Quincy quarries immediately formed the Granite Railway Company, and in 1827 the first rail transportation line on this continent was completed. It was about three miles long, and extended from the quarries to tidewater near the mouth of the Neponset river.



Early Railway Times

Viewed from the standpoint of to-day, this first railroad on American soil was a rather curious affair. It is hardly necessary to say that there were no block signals, or split-rail switches. As a matter of fact not even T rails were available; neither were wooden ties used as they are to-day.

In constructing the road the builders first laid end to end blocks of granite that were a yard or more long and six or eight inches square. To the inside edge of these blocks they spiked strips of iron that were about one-quarter of an inch thick, and two and one-half inches wide. This combination formed the rail. Such necessary appurtenances as frogs for

cross-overs were made by chiseling out grooves in great cubes of granite that weighed several hundred pounds.

But with all its crudeness, the old-time construction was builded well, and visitors to the site to-day find a considerable section of the ancient superstructure still in a good state of preservation.

And, ah, what a host of suggestive thoughts come trooping into the mind of the historical pilgrim as he stands beside the old roadbed. How vastly the world and its affairs have changed in three-quarters of a century. What a picture of progress and improvement is presented by a comparison of the ancient superstructure, and its track of rough-hewn granite, with the permanent way of a well-equipped modern railroad. It is indeed a far cry from the little railway that was built to carry the product of the Quincy granite quarries, to the great transportation systems of to-day, with their tens of thousands of miles of glistening steel rails, over which the commerce of a mighty nation is moved."

### Agitation in Favor of Canals.

The opening of the Erie Canal in 1825 gave New York such a generous grasp of western business, that the people of New England were soon agitating for extension of canals that would bring to them the products of the West in exchange for their manufactured goods, and schemes toward that end were agitated that would have rivaled in magnitude any canal enterprise ever undertaken, had they been carried out. One scheme called for the cutting of a canal tunnel through the Hoosac Mountains at an estimated expense of \$1,000,000. The experience of making a railroad tunnel through the same route would indicate that the work would have cost fifty times the estimate.

The New England people had never been very responsive to schemes that called for large expenditures of money, and the canal projects were wasted in the wind of talk.

### Granite Tramway Proposed.

The Legislature gradually came round to investigate the propriety of building railroads. A committee of influential citizens was appointed in 1829, and it returned a report which makes curious reading to-day. It recommended:

"That on account of the high price of iron in this country and

the abundance and cheapness of granite, the following form of construction should be adopted, namely, two parallel stone walls, laid so deep as not to be moved by the effects of frost, surmounted by a rail of granite about a foot in thickness and depth, with a bar of iron placed on top of it of sufficient thickness to form a track."

These stones were to be at a uniform distance of five feet from each other, as nearly horizontal as possible, and the space between them was to be filled to within six inches from the upper surface of the rail with earth and gravel so as to form a path for the horses employed in drawing the carriages. The board reported that on the railroads recently built and then in process of construction in



Early Railway Times

England and France, it was proposed to use locomotive engines; but the conclusion was reached that coal was so dear in this country and horses and fodder were so cheap, that horse power would be here more economical than steam power. It was stated that it was unnecessary to have the railroad absolutely level, as experience had shown that steady exertion of strength by a horse is more fatiguing than even a greater exertion occasionally remitted.

In a footnote appears the following interesting suggestion: "The labor of the horse may be still further relieved by providing a platform placed on small wheels on which the horse may ride on the long descents. This expedient, singular as it may seem to persons unaccustomed to observe the ease of locomotion on the rail-

road, is adopted with success on the Darlington and the Mauch Chunk railroads, and the horses eat their provender while they are returning to the point where their labor is to be resumed."

This scheme of building a railroad with granite blocks was by no means absurd, for similar tramways were built in oriental countries long before the Christian era, and some of them are still used in Italy. They have no bar of iron for the wheels to rest upon, but they have outside ridges which keep the wheels running upon the smooth surface of the granite blocks.

No satisfactory results came from the efforts of the State Legislature to promote railway construction. After a few years' delay railroad building was undertaken by private individuals; railroad companies were formed and construction pushed with vigor that soon put New England abreast of even Pennsylvania in the promotion of railway enterprises.

### People Decided to Help Themselves.

So long as State aid was relied upon to build the railways needed to connect Boston with the outside world individual effort lay dormant, but as soon as the fact became apparent that private effort alone could accomplish the desired means of intercommunication the people asserted their native energy.

The people were, however, by no means precipitate in their newly directed energy. After much discussion the Boston & Lowell Railroad, 26 miles long, was chartered in 1830. The Boston & Providence, 45 miles long, and the Boston & Worcester, 44 miles long, were chartered in 1831. In each case the Legislature tied a string to the bargain. The following provision in relation to tolls was inserted in each charter:

### Strict State Control.

"That a toll be and hereby is granted and established, for the sole benefit of said corporation, upon all passengers and property of all descriptions which may be conveyed or transported upon said road, at such rates per mile as may be agreed upon and established from time to time by the directors of said corporation. The transportation of persons and property, the construction of wheels, the form of cars and carriages, the weight of loads, and all other matters and things in relation to the use of said road, shall be in conformity to such rules, regulations and provisions as the directors shall from

time to time prescribe and direct, and said road may be used by any person who shall comply with such rules and regulations."

### Wanted Railroads Open to Every Vehicle.

The terms of the charters indicated that legislators considered that the railroads would be operated by horses and that the lines would be public highways on which any common carrier might introduce his haulage plant subject to the terms imposed by the charter. Similar ideas prevailed in nearly all the districts where pioneer railroads were being promoted at that time. The people had to be educated into the understanding that the



Early Railway Times

steam engine could be built to haul vehicles with more docility than the horse and mule and that steam handled traffic could not be mixed with animal hauled cars.

Events, that exercised a powerful educating influence, came in rapid succession at the time conservative New England on the railroad building question

Was standing with reluctant feet,  
Where the brook and river meet.

### First New England Railroad Opened.

Although it was the last of the three pioneer railroads to be chartered, the Boston & Worcester was the first company to begin

carrying passengers. The construction work had not been pushed very vigorously, for it was not until the charter was three years old (April 7, 1834) that an experimental train was run from Boston to Newton, a distance of seven miles. The month following saw a regular train service introduced and the cars of cultured Boston received its baptism of discordant whistle shrieks and other noises that are the jarring song of accelerated travel.

Short sections of the other railroads were opened for business soon after the Boston & Worcester trains began running, and railroad extension went on without much interruption until the tentacles of Boston's industrial energy reached into the farthest recesses of the commercial world.

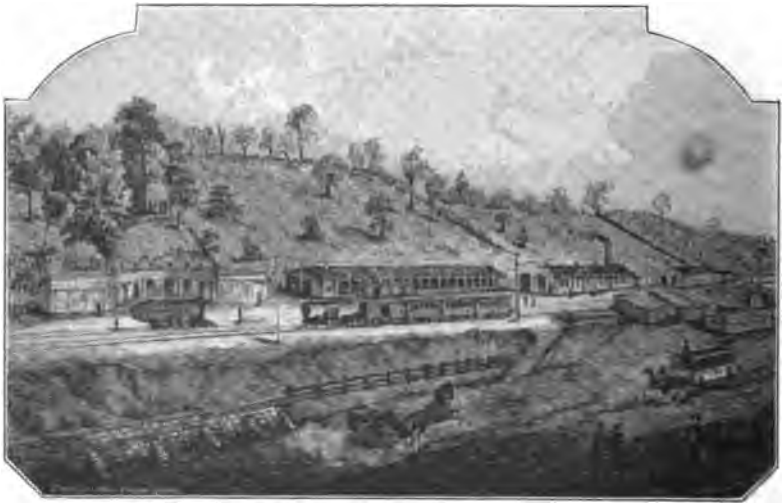

Early Railway Times

### Primitive Service.

The service first performed by the railroads about Boston was not unlike that performed by the modern electric car, but the charges were experimental, and, from a modern standpoint, excessively high. The tariff for the ride of seven miles from Boston to Newton was  $37\frac{1}{2}$  cents, children half price. When the first ten miles of the Boston & Providence was put in operation, the fare charged was 75 cents for a round trip. The travel was so light that the carriers made less profits than their modern successors do in charging 5 cents for greater distances.



### Tentative Enterprise.

The accumulation of property has a tendency to make people conservative, which is one reason for the people of New England having been slow to risk their capital and possessions in the furthering of railroad enterprises. They were contented to wait and see how other communities fared by embarking capital in the construction of railroads. When a little reliable information on this question was obtained, New England became noted for the vigor displayed by its people in pushing the iron highways into every region likely to supply a market for the numerous manufactured articles which this region was famous for producing.



Early Railway Times

### Reaching Into the Western Country.

The Boston & Worcester Railroad reached the terminus specified by its charter in 1835, but two years before that event persons interested in the company had incorporated a far-reaching extension called the Western Railroad. The charter gave this company the right to extend to the western boundary of the State; but the object of its promoters was to make connection with the Hudson River at or near Albany, N. Y. That point was reached in 1841, giving New England connection with the Erie Canal, then regarded as the ideal means of reaching the Great Lakes and the heart of the rapidly

developing western territories, which far-seeing men were beginning to regard as the coming seat of productive empire.

The portion of the Western Railroad system that extended in New York State from the Massachusetts line to Albany was called the Albany & West Stockbridge Railroad. The completion of that portion of the line was delayed somewhat through the covert opposition of New York State politicians acting in the interest of New York City merchants, who did not welcome a divided route for western transportation. There were also money restrictions through financial panics, the failure of the United States Bank, which happened in 1835, having exercised a most depressing effect. The Legislature of Massachusetts acted very liberally, however, towards the Western Railroad Company in their seasons of dis-

**BOSTON AND WORCESTER RAIL ROAD**

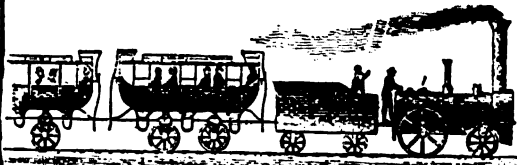

**T**HE Passenger Cars will continue to run daily from the Depot near Washington Street, to Newton at 6 and 10 O'clock, A.M. and at 3 $\frac{1}{2}$  O'clock P.M. and Returning, leave Newton at 7 and a quarter past 11 A.M. and a quarter before 5 P.M.

Tickets for the Passage either Way may be had at the Ticket Office, No. 617 Washington Street, Price 75 cents each, and for the return Passage, of the Master of the Cars Newton

By Order of the President & Directors  
a 29 Epifts F. A. WILLIAMS, Clerk.

Old Railway Time Table  
New England Train in 1834

trass, several times lending the credit of the State to tide over periods of depression.

### Major Whistler.

The Western Railroad Company was fortunate at its inception in having an extraordinarily able manager in Major George W. Whistler, chief engineer, who invented constructive details as necessity arose and overcame the difficulties of a new business in a manner that greatly accelerated the completion of the enterprise. No particular seemed too insignificant to receive his masterly attention, for he not only managed the surveys and work of construction, but

he organized the traffic office operations and arranged the methods of rolling stock repairs. His fame as manager of the Western Railroad brought him a tempting offer from the Russian Government which he accepted, and the United States lost the services of its brightest pioneer railroad engineer.

Major Whistler was the father of James Abbott McNeill Whistler, the famous artist, who began his career as a delineator by working on engineering drawings for his father. It is a curious comment on how the literary world discriminates between the man of utility and the man of art, that encyclopedias have extended biographies of the son, the artist, while not a word is said about the father who organized methods and forms of railroad business that became an inheritance of the whole world and are used to-day.

The Boston & Worcester, the Western, and the Albany & West Stockton railroads were the first links of what is now the Boston & Albany, part of the New York Central Railroad system.

### **Boston & Lowell Opened.**

The first of the three New England railroads to be chartered, the Boston & Lowell, was opened in 1835. The location followed the line of the Middlesex Canal, and construction work was very light. Lowell was then a growing town, stirred by textile manufacturing ambition, and Boston had about 77,000 inhabitants. There were various villages on the route of 26½ miles that were aspiring into towns, and the whole district was teeming with industrial activities that gave remunerative traffic to the new railroad. The line was very easy to operate, the rates charged were so remunerative that an annual dividend of 8 per cent. on the stock soon became the rule, and was kept up until 1878, when the property was absorbed into the Boston & Maine system. That great system, now operating about 2,300 miles of railway with 1,000 locomotives and 20,000 cars, was built up from a variety of small lines which traverse all New England and have arms reaching through part of New York State in one direction and to the boundries of Canada at several points.

### **Boston & Providence.**

The third of the pioneer railroads of New England, the Boston & Providence, had also a very prosperous career earning revenues that made embarrassment of riches until the property was swallowed

in 1888 by the Old Colony Railroad Company, a case like that of the lean kine eating up the fat ones. That in its turn was absorbed by the New York, New Haven & Hartford system, which obtained control of all the railroads extending New York-ward from Boston and many others of indefinite destination.

There are now, in 1907, only three railroad systems in the New England States, viz., the Boston & Albany, now a part of the Vanderbilt lines; the Boston & Maine, which controls all the northern and northwestern lines, and the Consolidation, as the New Haven possessions are called.

# Locomotive Building in New England

---

## CHAPTER XIII.

---

### **Early Sentiment Favored Animal Power.**

The original intention of the promoters of the first three pioneer railroads of New England was to operate with animal power, but education about railroads was disseminated so rapidly in the years these railroads were under construction that locomotives were provided for the hauling of trains as soon as sufficient track was laid on which to run them.

All the roads purchased a locomotive from Robert Stephenson & Company, of Newcastle, England; and the Boston & Worcester and the Boston & Providence Companies each bought an engine from Edward Bury & Co., Liverpool. These locomotives not only operated the first New England train service, but they also served as patterns for American builders to imitate.

There was something curious about the sentiments concerning designs that influenced the early builders of locomotives in New England. The South Carolina Railroad managers, the management of the Baltimore & Ohio and of several other of the first constructed railroads when machine shops were few and far between, depended upon native skill to design and build the locomotives they required, yet New England that was largely supplying the whole country with machinery for all sorts of industries depended slavishly upon British models of locomotives as guides for design and construction.

### **Growth of Locomotive Building in New England.**

The New England States being the principal seat of manufactures of a metallic character at that time, it was natural that the people should expect that their mechanics would secure the greater part of the business of building locomotives for railroads throughout the whole country. A good start was made in this

industry and it prospered for years, but its glory has departed, and New England has now ceased to build the locomotives needed for operating its own railroads.

The loss to New England of its locomotive building business is a curious illustration of trade vicissitudes. Within the first three decades of the railway era, sixteen or seventeen different works had built locomotives in New England and some of them were for a time among the most prosperous establishments of the kind in the world. Four of the first locomotives built in New England were turned out of a shop on the Mill Dam, now South Boston, and then came the Locks & Canal



Fig. 86. Lowell Engine, Built About 1837, Rebuilt 1846, Belonged to Stonington Railroad. James M. Anderson, Master Mechanic of Road, in Front

Photograph from which engraving was made loaned by Mr. Orman L. Pratt, Providence, R. I.

Company of Lowell. The name of this concern was changed to the Lowell Machine Shops after the business of building canal machinery collapsed. After them came Hinkley & Drury, followed by John Souther of South Boston; Seth Wilmarth of Boston; Taunton Locomotive Works of Taunton; Amoskeag Locomotive Company, Manchester, N. H.; White River Junction Iron Works; Corliss Nightingale, Providence, R. I.; Geo. Coney & Co., Ballardvale, Mass.; Mason Locomotive Works of Taunton; McKay & Aldus of East Boston; Lawrence Machine Works of Lawrence, Mass.; the Manchester Locomotive Works,

Manchester, N. H.; The Globe Works, South Boston; the Portland Locomotive Works, Portland, Me., and the Rhode Island Locomotive Works, Providence, R. I.

### Locks & Canal Company's Work.

The first concern to establish any mark as locomotive builders in New England were the Locks & Canal Company, Lowell, Mass., which afterwards became known as the Lowell Machine Shops Company. They began building locomotives in 1834 owing to prostration of their canal operations due to the depression in that kind of business through the growth of sentiment in favor of railroads. The Locks & Canal Company took the Stephenson's Planet type of locomotive for their model, and built quite a number of them for different railroads, but principally



Fig. 87. Hinkley's "Lion." First Engine Built by Firm

for those in New England. The report of a government commission appointed in 1838 said that there were thirty-five of these engines then in use. These engines, which are illustrated on page 32, had a single pair of driving wheels in front of the fire box, inside connected cylinders 11x16 inches, and one pair of carrying wheels under the smoke box. As the proportions of these engines became for a time the prototypes followed by the early New England locomotive designers, their dimensions will be worthy of study by people interested in locomotive development.

The driving wheels were 5 feet diameter outside of the tires, and the leading wheels about 3 feet diameter. The boiler had a slight wagon top with dome on top and was 34 inches diameter.

containing 66 copper tubes  $2\frac{1}{4}$  inches outside diameter, and 82 inches long. The fire box was 22 inches long inside, 42 inches wide and  $37\frac{1}{2}$  inches deep, the grate area being 6.4 square feet. There were about 37 square feet of heating surface in the fire box and about 262 square feet in the tubes, making a total of about 300 square feet of heating surface.

The engine had drop hook valve motion operated under the smoke box. The steam ports were  $1\frac{1}{4}\times 6$  inches, and the exhaust port  $1\frac{1}{2}\times 6$  inches. There were two nozzles each  $1\frac{1}{2}$  inches diameter. The engines weighed in working order about 23,000 pounds, of which 14,500 was on the driving wheels. The fuel burned was wood.

That was a standard locomotive for a few years and great

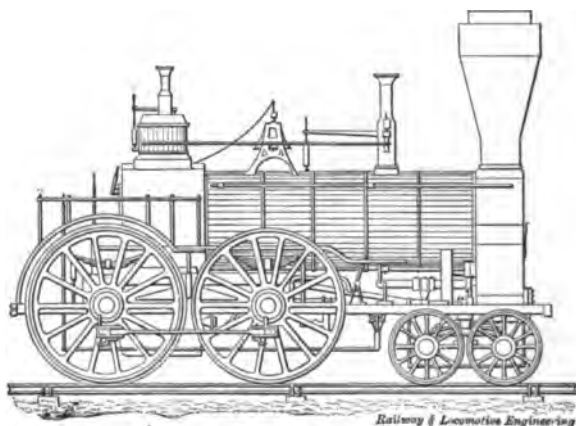

Fig. 88. Second Type of Engine Built by Hinkley & Drury

opposition was offered to the iconoclast who first proposed building other forms.

As the weak points of the Planet type of engines became thoroughly recognized, many of them were rebuilt like the engine shown in Fig. 86. In this case the boiler has been lengthened and a pair of trailing wheels added.

The Lowell Machine Shops suspended locomotive building after they had turned out about forty engines, but in 1847 they tried that line of work again and built two engines for the Boston & Lowell Railroad, which displayed some development, for they were four wheel inside connected with a four wheel truck in front. The cylinders of these were  $15\frac{1}{2}\times 18$  inches, the driving wheels being 66 inches diameter. That ended the work of



the first important locomotive building company in New England. Their engines never were popular and made little mark on the art of locomotive building.

### Hinkley & Drury's Start in Locomotive Building.

In 1839 Hinkley & Drury began locomotive building in Boston, their first engine being the "Lion" (Fig. 87), which was carried on four wheels connected and had outside cylinders. That engine resembled the De Witt Clinton, belonging to the Mohawk Valley Road, but had a slightly larger boiler with a



William Mason, Noted Locomotive Builder

small wagon top fire box and a big dome on the middle of the boiler. Hinkley & Drury engaged seriously in the work of locomotive building and eventually turned out many excellent locomotives that compared favorably with the productions of the best shops in the country. In their second engine (Fig. 88) they yielded to the popular trend of New England practice, introduced by the Locks & Canal Company, and made an inside cylinder and four wheel connected engine which had, however, a four wheel truck in front. This practice of building inside connected engines was followed by Hinkley and Drury for about ten years,

until the demand of railroad companies for outside cylinder engines induced the builders to conform to the popular taste and do away with the necessity for a cranked axle.

It is curious how wedded some men become to the idols of their own conception. Isaac Hinkley, the head of the Hinkley Locomotive Works, reluctantly consented to build outside connected engines; yet it is said that on his deathbed he expressed the belief that the most serious mistake of his life was changing from the making of inside to outside connected locomotives.

The Hinkley Locomotive Works built up a good business very rapidly and some of their engines became famous. The "Antelope," built for the Boston & Maine in 1845, had a single pair of drivers 6 feet diameter, a four wheel truck in front and

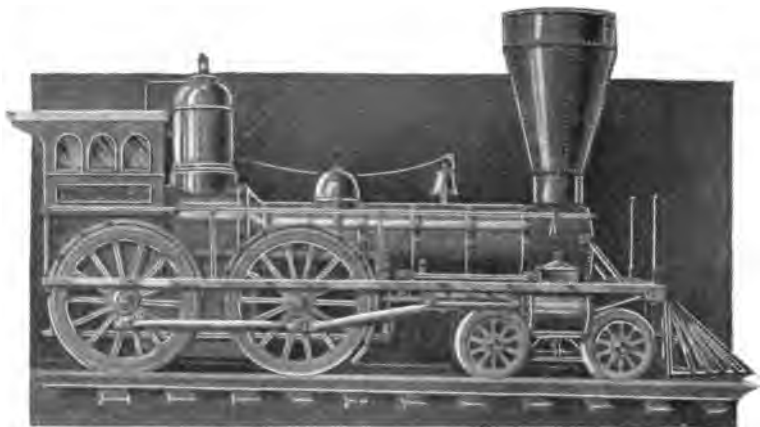

Fig. 89. Mason's James Guthrie

a single pair of carrying wheels under the foot plate. This engine was noted for fast running, but was too much given to slipping to hold popularity. Express engines with a single pair of large driving wheels were then becoming popular in Europe and many of them are still to be found at work there; but they have never been successful in the United States, although many of them have been tried at various times.

### The Homely Pioneer Locomotive.

Most of the pioneer locomotive builders in New England, and in fact everywhere, entered the business for the purpose of making money, and there was small pretense of undertaking to

produce something better, or more artistic than the prevailing forms. The idea was to build a fairly durable engine that would perform the work required as well as the locomotives of any other builders. "A thing of beauty is a joy forever," suggests a practice of refinement that the mere aim at utility had no sympathy with in the days when mechanics were working the locomotive into a reliable engine. The fantastic vagaries that move the noble red man and his squaw to paint their faces with red lead is not more inconsistent with the sense of harmony, or natural fitness, than were the untutored tendencies of early locomotive builders to burden their engines with glittering brass loaded upon unharmonious forms. That was the unlovely condition of the locomotive when William Mason, scorning the ease and luxury of building textile machinery, joined himself to the list of locomotive builders.

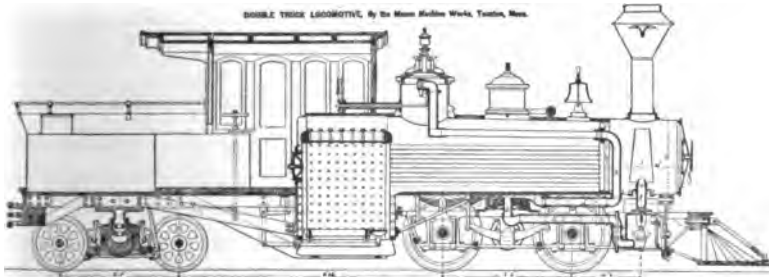

Fig. 90. Mason's Double Truck Locomotive

### Mason Beautifies the Locomotive.

Up to the time that William Mason began building locomotives in 1852, the ideas of art harmony as applied to locomotive designing appear to have had no place in the minds of men carrying on the work. They labored with some success to produce locomotives that did the work of hauling trains with fair economy, and they worked out proportions that provided the required strength without carrying a burden of unnecessary material; but no attention appears to have been bestowed upon the outward appearance of locomotives, so far as making the visible outlines harmonious, was concerned. There was a great deal of ornamentation put upon some of the parts, but the effect on æsthetic taste was often grotesque where beauty was aimed at. Elaboration of brass in bands and coverings of domes, sand

boxes, wheel covers, steam chests and cylinders with great varieties of paint on other parts, conveyed the impression one receives from looking at the garments of an overdressed woman. Those were the days when the red smoke stack and vermilion painted wheels were regarded as a mark of distinguishing beauty. It was then considered the correct thing to spend hundreds of dollars on the painting of portraits or picturesque scenes on headlights, cab panels and tenders.

Mason took the lead in making locomotives that were handsome without the aid of glittering brass and ostentatious painting. As can be judged from the picture of his first engine, the James Guthrie (Fig. 89), compare that with the crudities of earlier date. Mr. M. N. Forney, in the course of an obituary notice of William Mason, says: "He was a wonderfully ingenious man and combined with his ingenuity a high order of the artistic sense, so that his work was always most exquisitely designed. It might be said of his locomotives that they are 'melodies cast and wrought in metal.'"

### **Building Locomotives for Fun.**

In the course of an interview concerning his business, Mr. Mason said: "My principal business has been making cotton machinery. At the time I commenced locomotive building, there was a little slackness in cotton machinery, and for that reason I took hold of locomotives. My locomotive business is now the meanest part of it and always was. I took an interest in it and tell my friends that I got up locomotives for fun, but that it was the most expensive fun I ever had. I make just enough money from my cotton machinery to make up the losses on locomotives." That may explain why so many concerns were overtaken by financial disaster building locomotives.

As Mason's work exerted great influence on locomotive construction in the United States, I shall give more particulars concerning his first engine than it is convenient to give to other celebrated locomotives.

### **Mason's Work as a Locomotive Builder.**

Mason began building locomotives at Taunton, Mass., in 1852, and his first engine (Fig. 89) here illustrated by half-tone engraving. The engine was built for the Jefferson Railroad in Indiana, and Reuben Wells, now general manager of the Rogers Loco-

motive Works, who was then master mechanic of the railroad named, received it. In a letter to "Locomotive Engineering," published in 1898, Mr. Wells described the engine. He wrote: "It was called the 'James Guthrie' for one of the directors of the road and Secretary of the Treasury under President Pierce. The engine was of the eight-wheel American type, cylinders  $13\frac{1}{2} \times 22$  inches, drivers 66 inches diameter, weight about 60,000 pounds.

"The cylinders were horizontal and were interchangeable, but bolted to a cast iron saddle, in whose upper face the smoke box rested and to which it was bolted. The cylinders were attached to this saddle at the frames. The inside face of the cylinder and the base of the saddle where they joined made the joint for the exhaust passage, the latter extending inward and upward to the base of the exhaust pipes, which were double

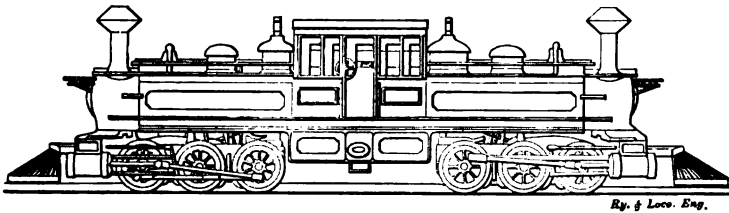

Fig. 91. Mason's Double End Locomotive

with tips as high as the top row of tubes. The steam chests had a goose-neck extension from their inner side into the smoke box to which the steam pipe was secured. The head and nut were 'balled' to make the joints and a cast iron ring bent on one face and balled on the other made the joint.

"The steam ports were about 13 inches long, tapered  $1\frac{1}{4}$  inches wide in the middle and 1 inch at the ends. The joints of steam chests and cylinder covers were flat and a gasket of sheet copper was used to make them steam tight. The cylinder heads were made hollow to provide an air space and they were polished with the idea of preventing the radiation of heat.

"The throttle was a slide valve located in the smoke box, operated by a rod inside the dry pipe, which ran from it to the usual style of lever on the boiler heads.

"The boiler was wagon top but without the usual taper connection, the barrel of the boiler being flanged to the fire box

sheet. The crown sheet was supported by bars, the tubes were of brass 2 inches diameter and 11 feet long. The iron fire box was about 33x48 inches inside providing about 11 square feet of grate area.

"The crossheads were of cast iron lined with babbitt metal working in iron guides. The valves were worked by a shifting link motion of a pattern practically the same as that used to-day. The lifting shaft was located above the eccentric rods, the eccentric straps were of cast iron attached to flat ended eccentric rods by three bolts."

Special claims for advanced practice were made for the engine frames, but I shall use Mason's own description of his design. In the course of the interview already quoted from, Mason said:

#### **Mason on What He Did for the Locomotive.**

"The most popular locomotives at that time were those built by Rogers. The first idea I had about improving the engine was to put the cylinders down level. As it was built at that time, the locomotive looked like a grasshopper. The old Baldwin engines were worse in this respect than the Rogers. The cylinders were all set up so as to be above the truck. Another thing on the old fashioned engines was, that if anything was the matter with the frame at either end, you had to take the whole engine down. I was the first to make the front end of the frame separate from the back end so that one part could be removed without removing the other parts. I made the driving wheels with hollow spokes and hollow rim. I also got up a set of truck wheels. Before that the ordinary truck wheels looked like cheeses. I wanted my truck wheels to have some relation in appearance to the drivers; therefore, I never put a plate wheel under any truck that I built. I also put the counter balance into the rim of the driving wheels by pouring lead into it and now I have it down to perfection.

"Rogers used the link motion before I did; but he hung it from below. I hung the link above the center and had the suspension hanger the same length as the rocker arm so that the link block would not slip at all. At that time I was trying to prevent the slipping of the block, but I found afterwards that the slipping of the block was of little consequence, because if it slides at all, it is just as well to slide six inches as two inches,

so far as the wear is concerned. A little motion of that kind sometimes wears more than a long motion.

"I introduced the use of conical ended stay bolt for the crown sheet and everybody soon adopted that plan.

"I designed the arrangement of wedges in the jaws for locomotive driving wheel boxes. I put a shoe next to the box and a wedge behind the shoe and between it and the frame, so that the wedge was out of sight. Rogers adopted that plan. After a while I found that it was not a good way to have a wedge on both sides, because the men running the engines were sometimes careless and would shove up one side too much, so I made one side of the frame straight and put a wedge on one side only. I now make both jaws straight and put the wedge behind the shoe."



Mason's Saxon, a famous engine in its day, about 1865

### Opinion of Mason's Work.

Mr. Mason went on at considerable length to tell what he had done for the locomotive in various other ways and some of his ideas were found to be fallacies. Some of the claims I have quoted are not well founded, as, for instance, that of being the first to use a divided frame, a practice Wilson Eddy had employed on the Addison Gilmore, built a year before Mason began locomotive building. Mason was very much like a great many other inventors and improvers of mechanism, memory played him tricks that made him imagine that he originated improvements which other minds had devised. His work on improving the appearance of the engine was genuine and he took very positive ground in making the parts interchangeable. The locomotives designed and built by Mason indicate that he un-

derstood thoroughly the practical purpose they had to serve and the difficulties to be met, and he provided for the requirements in a thoroughly skilful manner, natural to a man who was a first-class mechanic. When he undertook, however, to build an unusually powerful locomotive to meet the demands of transportation interests that he perceived was bound to come, his work was not successful. He devoted immense labor and expended no end of energy and money in putting upon the market double ended locomotives, as shown in Figs. 90 and 91, and locomotives having the driving wheels arranged as a flexible truck. No particular advantage was found in the arrangement and Mason's "bogie" engines, as they were called, attained no popularity.



One of the Last of the Masons for Old Colony Railroad

Mason's eight-wheel engine greatly helped to establish the form of the so-called American type of locomotive, and all that subsequent builders did for many years was to increase the proportions. A variety of odd forms were tried at various times; but the engine with horizontal cylinders over a spread truck, well balanced driving wheels with cast iron centers, divided frames and wagon top boiler, held supreme favor, minor differences in details providing the excuse for designers and builders speaking of certain engines being their standard.

#### One of Mason's Failures.

One of Mason's would-be improvements upon the locomotive which brought disappointment was the introduction of the



Walschaerts valve motion. At the Centennial Exposition, held at Philadelphia in 1876, Mason exhibited an engine equipped with the Walschaerts valve gear. It attracted great attention owing to the oddity of its action when the engine was in motion. The railroad mechanics of the United States were, however, more amused than attracted by the novelty of that gear. Many of the men who examined it were familiar with numerous forms of curious valve gear that had been displaced by the link, and the remembrance did not encourage them to regard favorably the assortment of swinging levers that Mason was offering to introduce as an improved form of valve gear.

Mason was not, however, discouraged by the cool reception given to the Walschaerts valve motion, for he proceeded to apply it to locomotives and to urge its adoption. Apart from the conservative tendencies of railway men to regard novelties in locomotive attachments with suspicion there were several things about the Walschaerts valve gear that excited animosity among locomotive engineers. Up to that time the locomotive engineers had been at liberty to alter the lead of their valve gear any time they felt so inclined, and the Walschaerts gear did not lend itself to changes of that kind. Then the lead was constant, which was a source of annoyance and a conspicuous object of animosity. The engineers raised sufficient opposition to kill the Walschaerts valve gear at that time.

### Mason's Double Ender.

The mistakes made by William Mason arose mostly through ambition to introduce forms that the railway world was not prepared to adopt. The Walschaerts valve motion is now becoming popular on American railroads.

In 1871 Mason built a double ended locomotive called the "Janus," then spoken of as being the Fairlie type of engine. The engine was bought by the Lehigh Valley Railroad Company and performed very satisfactory service on the heavy grades, but the railroads were not then prepared to purchase other engines of that character. Recently the Schenectady Locomotive Works built a huge double ender for the Baltimore, which is spoken of as the Mallet type. At the time this chapter is going through the press the Baldwin Locomotive Works have built some of these huge double enders for the Great Northern Rail-

way. That may be the beginning of the demand for a type of locomotive which will vindicate Mason's judgment and farsightedness.

### **The Allen Double End Locomotive.**

In considering the development of the locomotive that led to the double ender, it is only fair to note that such type of engine was designed by Horatio Allen and built for the South Carolina Railroad in 1831. The engine is illustrated and described on page 58.

Making what might be called two engines so that they could be handled by one man seems to have been a favorite idea with people responsible for hauling freight at low cost and for operating heavy gradients. Allen's engine was a failure because the time for heavy locomotives had not yet arrived, but his work was not altogether lost. It was an "American idea" that other countries were soon willing to utilize.

### **Prizes Offered by Austrian Government for Powerful Locomotives.**

Outside of the United States the first railways to raise a demand for more powerful locomotives than the common types of the time were those of Continental Europe, particularly the railways of Austria. In 1852 the Austrian Government offered a series of prizes for locomotives to fulfill certain requirements in operating a line up the Semmering Pass over the Noric Alps, having a grade  $13\frac{1}{4}$  miles long, 112 feet rise to the mile. The first prize was won for a locomotive that utilized the weight of the tender for adhesion by connecting the tender wheels with the engine wheels by means of an endless chain, a scheme tried by George Stephenson in 1815 and given up as a failure.

### **Engerth's Locomotive.**

The endless chain arrangement soon had to be abandoned, and William Engerth, locomotive engineer to the Austrian Government, brought out the form of engine (Fig. 92) that came to be known in America as the Forney type, the frame of the tender being extended to connect with the engine frame. The front pair of tender wheels were placed ahead of the firebox and were connected with the driving wheels by side rods. The coupling of engine and tender was close behind the trailing wheels and the tender frame was so arranged that it could

move radially in rounding curves. This arrangement had previously been devised and used on locomotives built by Ross Winans for the Baltimore & Ohio Railroad.

### Beugnot's Heavy Hill Climber.

In 1860 a notable form of heavy locomotive was patented in France by Mons. Beugnot, shown in Fig. 93, and two of them were built for the Paris, Lyons & Mediterranean Railway. The engines weighed about 100,000 pounds, had cylinders  $21\frac{1}{4} \times 22$  inches and 1,861 square feet of heating surface.

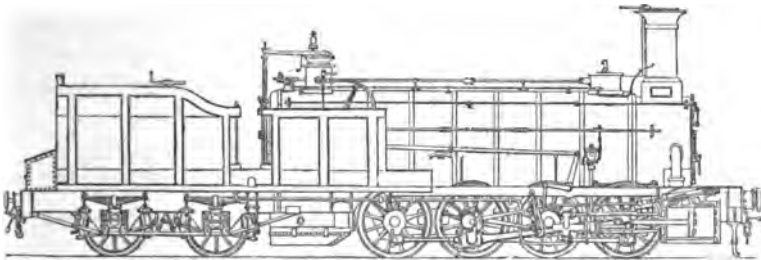

Fig. 92. Engerth Goods Engine, Nord Railway of France, 1856

Part of the weight of these engines rested upon the tender as in the Engerth engines. A curious arrangement for transmitting the power was that the piston rod worked through the front cylinder head operating a strong crosshead which had a rod on each side connecting with an inside and an outside crank.

### Petiet Double Enders.

The next notable locomotives we come to are a type designed by Mons. Petiet, chief engineer of the Northern Railway of France, in 1863. As seen by Fig. 94, these engines had two sets of driving wheels, six-wheel connected, driven by two pairs of cylinders. At a first glance a reader might conclude that these engines were the same as the double ender brought into use by M. Mallet, but they are different in an important particular, the wheels being secured in a rigid frame. The flexibility that enabled these engines to round curves was produced by giving the wheels connecting with the main rods  $\frac{7}{8}$  inch lateral play. The diameter of the cylinders was  $17\frac{1}{2}$  inches, the stroke being equal to the diameter. In working order the engines weighed 135,000 pounds.

The boilers of these engines were of unusual size, and the steam drying apparatus and chimney were novel in their arrangement. The fire grate was 6 feet  $\frac{3}{4}$  inches long, and 5 feet  $10\frac{7}{8}$  inches wide, being placed quite above the wheels (which ran upon the 4-foot- $8\frac{1}{2}$ -inch gauge). The area of the fire grate was 35.84 square feet—greatly exceeding that for any locomotives previously constructed, with the exception of those designed by Zerah Colburn, illustrated in the chapter treating of the Lackawanna Railroad. The height from the fire grate to the crown plate was 3 feet  $9\frac{5}{8}$  inches at the back, and 4 feet 4 inches at the tube plate; and the whole area of the firebox heating surface was 108 square feet. The boiler was 4 feet 10 inches in external diameter, and contained 464 tubes 1  $37\text{--}64$  inches in ex-

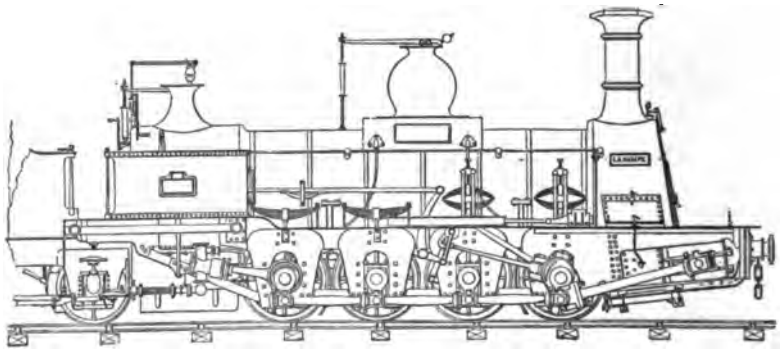

Fig. 93. Beugnot's Goods Engine, by Koechlin, 1860

ternal diameter, and 11 feet  $5\frac{3}{4}$  inches long, the external tube surface being 2,201 square feet. The waste heat, however, instead of passing directly into the chimney, traversed a tubular steam chamber, thereby drying the steam. The area of this "dryer" was 154 square feet. The chimney and blast pipe were horizontal, this position answering every purpose with an artificial draught. The chimney was turned up at its end, to prevent discharging the products of combustion directly over the train. The boiler pressure was 118 pounds per square inch.

I give these figures to show that it was an exceedingly powerful locomotive for that time. From twenty to thirty of these engines were put to service on different railways, and they performed very satisfactory work, especially on mountain grades.

### Fairlie's Double Enders.

In 1866 Robert F. Fairlie, locomotive superintendent of the Londonderry & Coleraine Railway in Ireland, built a double ended locomotive of the Allen type with two separate boilers for a little 2-foot gauge line called the Festenog Railway, which proved a success and excited much interest in the engineering world. In connection with this very narrow gauge railway Fairlie conceived the idea that the standard gauge was too wide for the economical movement of trains and he became a most zealous advocate of narrow gauge railways, one meter being his favorite width. His views led to much controversy

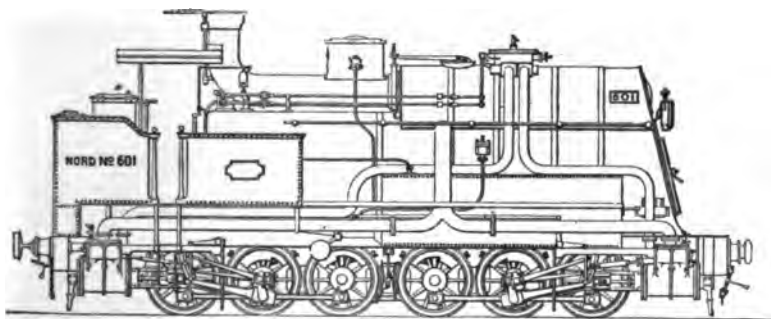

Fig. 94. Petiet's Double-End Locomotive, Built in 1863

for eight or ten years, especially in the United States, where he had many followers, the result being that the construction of narrow gauge railways became for a time the rage. Fairlie was able, earnest, indefatigable; he laid hold of and boldly advanced every argument which would serve his turn, good, bad and indifferent, and he met with the success which determined enthusiasts generally achieve. His efforts were always pushed in the interest of his double headed locomotive which he considered indispensable to the success of narrow gauge railways.

The engine never gained much favor for ordinary operating of narrow gauge railways, but it became popular for working heavy grades even on standard gauge railways. A great many of them were ordered for the railways of Mexico, Argentine, Brazil, New Zealand, and a few went to different countries in Europe, some to Africa and a few to Australia.

Mason claimed no credit for his designing of double ended locomotives but called them Mason-Fairlies.

### Mallet's Designs.

In 1876 Mons. Anatole Mallet, a French engineer, designed some two-cylinder compound locomotives for the Bayonne & Biarritz Railway of France; small affairs they were, but they demonstrated that compound locomotives could be operated satisfactorily and their success paved the way for the extensive introduction of compound locomotives that came later.

Mons. Mallet was ambitious to develop the compound system for unusually powerful locomotives. With that end in view, about 1888 he introduced four-cylinder articulated engines. The high pressure cylinders were fastened to the rear part of the main frames driving one set of wheels, and the low

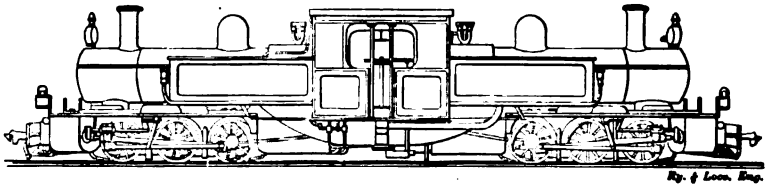

Fig. 95. Fairlie's Double-End Locomotive

pressure cylinders were carried on a truck actuating a second set of driving wheels.

The Mallet double ended locomotive seemed to put into proper engineering form the design that with many previous improvers was a vague, undefined conception. It promises to be the fittest form for a locomotive to do the maximum measure of work on a track of limited gauge. It has already become popular on mountain railways in different parts of the world and the United States will doubtless utilize its greatest possibilities.

Double ended Fairlie locomotives are popular in some countries where heavy gradients have to be worked, but they have not hitherto met with favor in the United States. The Denver & Rio Grande Railroad Company purchased two of them when the road was first opened, but they never were liked and it was difficult getting engineers to run them. The story is told of an Englishman who went to Denver looking for a job, being hired specially to run one of the Fairlie engines. He was stationed at the foot of a long steep grade, the Fairlie acting as a pusher. One day this Englishman, who had not been accus-

tomed to the guidance of a time table, intruded upon the time of a passenger train and orders were issued to suspend him for ten days. Another engineer, who did not know anything about double enders, was sent to relieve the Englishman. He reached the engine in due course and proceeded to question the engineer in charge as to how the machine was worked. After listening patiently to explanations as to the use of certain levers, rods, handles, lubricators, etc., he turned to the man he was going to relieve and said: "You keep on running this engine and I'll take the ten days."

### Baldwin Flexible Double Ender.

The introduction by the Baltimore & Ohio Railroad of a double ended Mallet locomotive was not the first modern move-

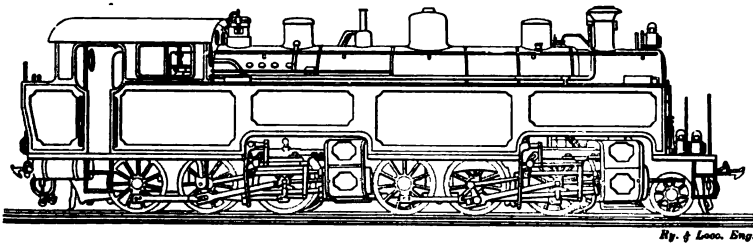

Fig. 96. Mallet Articulated Double-End Locomotive

ment in that direction. The engine shown in Fig. 97 was built by the Baldwin Locomotive Works for the Sinnemahoning Valley Railroad in 1892 to work on grade 575 feet to the mile. The engine has Vaucain compound cylinders  $9\frac{1}{2} \times 18$  and  $16 \times 18$  inches. Separate swivelling trucks are employed and the flexible steam pipe arrangement is effected by the use of Moran patent flexible joints. The weight in working order is 150,000 pounds.

It is difficult to anticipate the entire consummation of locomotive power in the shape of double enders, but to-day, on January 1, 1907, an active demand has arisen for this form of engine among railroads having steep grades. The latest act in this movement has been the ordering by the Erie Railroad Company of a

### Trio of Mallet Compounds.

These engines will be used as pushers on the grade east of Susquehanna, Pa. Locomotives of this type are still a novelty,

but the few that have been built, though many tons lighter than these Erie monsters, have given such good service as to practically place them at the top notch as heavy grade helpers. The American Locomotive Company, which is building them, gives the following dimensions: There will be 16 driving wheels, four cylinders, the boiler will be over eight feet in diameter at its largest part and will contain  $2\frac{1}{4}$  inch tubes to the number of 468, each 21 feet long, or more than a mile and three-quarters, if joined together all in a line. The driving wheels will bear all

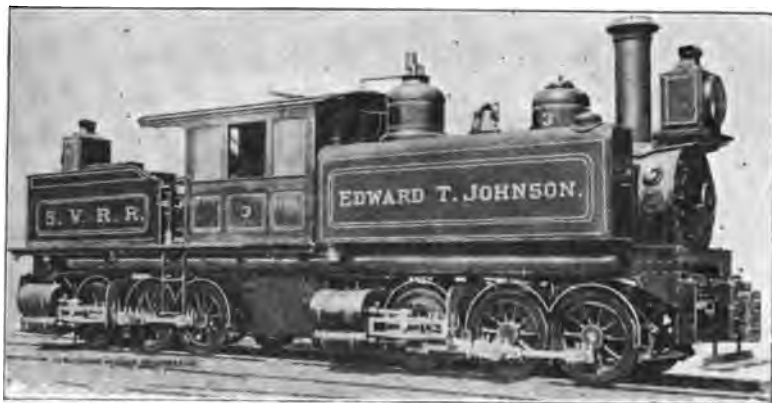

Fig. 97. Baldwin Flexible Double Truck Engine

the weight of the engine, and thereby will be secured the advantage of every pound of adhesive weight.

These engines will greatly exceed the one on the Baltimore & Ohio, or the latest example in this country of the Mallet type of locomotive, the Great Northern engines, recently built by the Baldwin Locomotive Works. The proposed design, which is here illustrated in outline, is for an engine weighing 410,000 lbs., with a tractive effort of 98,000 lbs. A comparison of the principal dimensions with the Baltimore & Ohio and the Great Northern engines will be of interest:

Road—Baltimore & Ohio.	Great Northern.	Erie.
Builder—Am. Loco Co.....	Baldwin.....	Am. Loco Co.
Wheels, 0-6-6-0.....	2-6-6-2.....	0-8-8-0
Total weight, 334,500 lbs.....	355,000 lbs.....	410,000 lbs., est.
Weight on drivers, 334,500 lbs.....	316,000 lbs.....	410,000 lbs., est.
Size of cylinders, 20 and 32x32 ins..	21½ and 33x32 in..	25 and 39x28 ins.
Diameter of drivers, 56 ins.....	55 ins.....	51 ins.
Tractive effort, 71,500 lbs.....	71,600 lbs.....	98,000 lbs.
Steam pressure, 235 lbs.....	200 lbs.....	215 lbs.



Road—Baltimore & Ohio.	Great Northern.	Erie.
Total wheel base, 30 ft. 8 ins.....	44 ft. 10 ins.....	39 ft. 2 ins.
Driving wheel base, rigid, 10 ft.....	10 ft.....	14 ft. 3 ins.
Total heating surface, 5,585 sq. ft....	5,658 sq. ft.....	6,108 sq. ft.
Grate area, 72.2 sq. ft.....	78 sq. ft.....	100 sq. ft.

The double ended locomotive built by the Baldwin Locomotive Works for the Great Northern Railway, whose leading dimensions are given in the above table, is illustrated in Fig. 99. It has two six-wheel connected sets of driving wheels and a pony truck at each end.

### The Passing of New England Locomotive Builders.

All the locomotive builders in New England whose names have been mentioned have retired from the business except the Manchester Locomotive Works and the Rhode Island Locomotive Works. The business of locomotive building appears

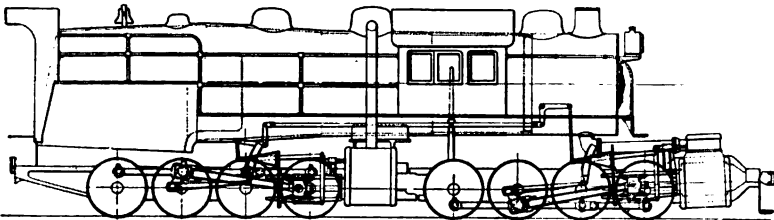

Fig. 98. Schenectady-Mallet Compounds for Erie

to have been peculiarly disastrous to those who located in New England. Unrestrained competition was the principal cause of failure, but attempts to defy the principles of business that demand up-to-date equipment brought some concerns to grief.

Most of the New England locomotive builders were contented to follow the beaten path of design and construction, but a few of them displayed enterprise in developing the engine. After Hinkley & Drury, and William Mason, the most courageous builder was Seth Wilmarth. He built a remarkably good inside connected engine which stood so high on the wheels that railroad men called them Shanghais, after a long-legged barn fowl popular in those days. Wilmarth, who was an excellent mechanic and enterprising engineer, had his career as a locomotive builder ended through a contract he took to build a large number of locomotives for the Erie at a ruinously low price.

Some of the builders turned out certain engines that be

came celebrated, such as the huge wheeled "Mameluke" built by the Amoskeag Company in 1849; but most of them moved in the even tenor of their way without other ambition than making money quickly. When business was active they paid large dividends without improving their machinery and plants. When the inevitable hard times came most of them gave up the ghost by starvation, due to improvidence.

### Forces That Developed the Locomotive.

Scientific theories concerning steam and the steam engine provided very little help to early locomotive designers in proportioning the dimensions likely to produce the most satisfactory results. It was easy to calculate the strength of boilers



Fig. 99. Baldwin Great Northern Grade Climber

and the thickness of plate necessary to withstand certain pressures, it was within the ability of most intelligent locomotive engineers to figure out the power transmitted through the cylinders; but ascertaining the proportions of boilers to cylinders and the proportion of stroke of cylinder to the diameter were for a time unknown quantities, as was also the proper weight on driving wheels to provide necessary adhesion, all of which questions were settled principally by experience.

No important invention that I am acquainted with is so little indebted to science for its development as that of the locomotive. It has been perfected by hardworking practical mechanics, and with the exception of the injector and the air brake, no attachment, even of the locomotive, has had a scientific origin.

# Work of New England Pioneer Master Mechanics

## CHAPTER XIV.

### Master Mechanics as Locomotive Improvers.

Most of the early railroad companies, when their roads were first put in operation, considered that it was necessary to provide facilities for building and repairing their rolling stock.



George S. Griggs

The development of first-class locomotive and car contract building shops in the United States convinced the railroad companies, however, that they could purchase rolling stock cheaper

than they could make it, but for a time many companies built a part of their motive power and the experience thus gained exerted good influence on locomotive designing. The convenience in operating and in simplicity of parts, for which the American build of locomotive is celebrated the world over, was originally the result of the designers having had experience in running and in repairing locomotives.

### George S. Griggs.

The first master mechanic of New England to make an indelible mark upon the locomotive and to earn celebrity in connection with railroad machinery was George S. Griggs, the first

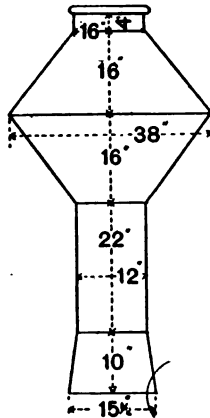

First Diamond Stack Ever Made

Designed by George S. Griggs, of the Boston and Providence

head of the mechanical department of the Boston & Providence Railroad. During the first few years of his incumbency, he was kept busy building shops and organizing his department; but after that work was done he devoted himself to the building of locomotives and to the working out of improvements upon the engine.

### Griggs' "Norfolk."

The first engine built by Mr. Griggs was the "Norfolk," which was put into service in 1845 and was long considered the best locomotive built in New England. The engine was four

wheel connected, had inside cylinders and a swiveling truck, being the first inside connected engine to have that useful appliance. The cylinders were  $14\frac{1}{2} \times 18$  inches, and the driving wheels 55 inches diameter outside the tires. The boiler was straight except where the barrel joined the fire box with an angle iron connection. It was made of iron throughout. It had 116 copper tubes  $1\frac{3}{4}$  inches diameter and 9 feet 6 inches long, providing 504.8 square feet of heating surface, including 44.8 square feet of fire box surface. The grate area was 8.75 square feet. The dome which contained the throttle valve was in the middle of the boiler and a man hole was provided on top of the fire box.

The frame, of two bars,  $5 \times 5\frac{5}{8}$  inches, and one  $2 \times 2$  inches.

The pedestals, or jaws, were of cast iron, with tenons at

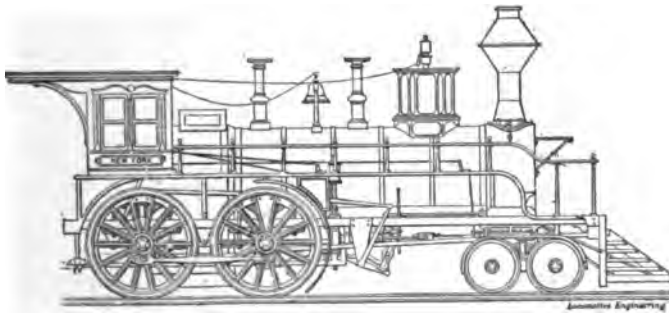

Fig. 100. Boston & Providence, Griggs Engine, About 1852

the top. The cylinders were cast with flanges on both sides. The flanges on the inner sides to hold them together by means of a casting which formed the center pin for the truck.

The flanges on the outside of the cylinders were bolted to casting which was riveted into the frame.

The tender was mounted on three pairs of wheels and had no swiveling truck. This style of tender was used many years, and there was less flange wear on the wheels than with the swiveling truck. With extra long tender, the case would be different.

The valve gear had four drop hooks. Under each hook was a runner which rested on a half round cam so that turning the cam shaft would lift two hooks and drop the other two.

The hooks moved the valves by means of a rocker to the top arm of which the valve stem was jointed. The point of

cut-off and exhaust could not be varied, but by means of lap and lead in the right proportion a good distribution of steam was produced and high speed was attained.

In 1849 the fastest train to Providence was in one hour and fifteen minutes, including one stop of five minutes. The distance is now covered in one hour, with no stops. A saving of ten minutes in time to the public after fifty-four years!

### Early Shop Practice.

Mr. Griggs built locomotives at the Boston and Providence shops as long as he lived, and when more were needed than he could furnish, locomotive builders built them. He took up all real improvements as fast as they appeared, increased the ca-

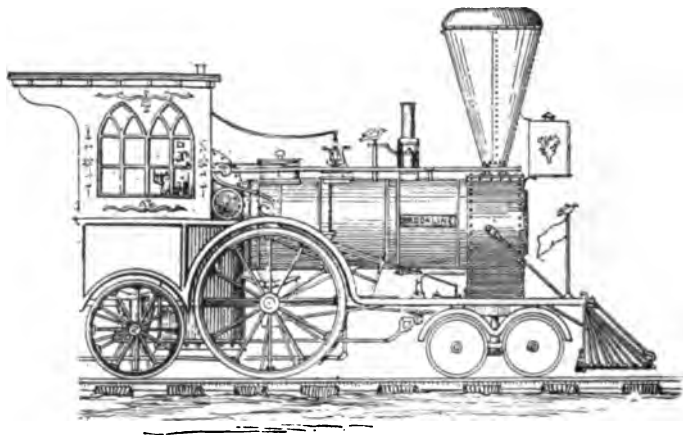

Rebuilt Bury on Boston & Worcester, 1840  
Originally Built in Liverpool, 1835

capacity to meet the want of more power, and was never behind the times. In 1852 he built locomotives with link motion valve gear and soon changed all the old locomotives to the then new valve motion. All small fittings such as safety valves, gauge cocks, cylinder cocks, blowoff cocks, tank and supply pipe cocks, pump valves, whistles, etc., for the earlier locomotives, were made in his shops with inferior tools, which, to-day, would be worth scrap price, less cost of breaking up.

Driving wheel tire flanges were shaped with a hand tool. Taper fits of piston rods were often made with a hand tool.

Screw threads were, for the want of dies and screw lathes, often made with hand tools on the catch-up plan.

Tires, weighing six or eight hundred pounds, were heated and shrunk on without the aid of crane, derrick or falls. Car wheels were keyed and pressed on by devices worked by hand.

For many years all eccentrics were keyed on the shaft before the wheels were put under the locomotive, thus insuring the right position. In case of a change of lap or lead of valves the eccentrics were moved to the new position. An offset key was put into the keyways and the job was done. All this is direct evidence of the commanding ability of George S. Griggs as a mechanic and as an organizer.

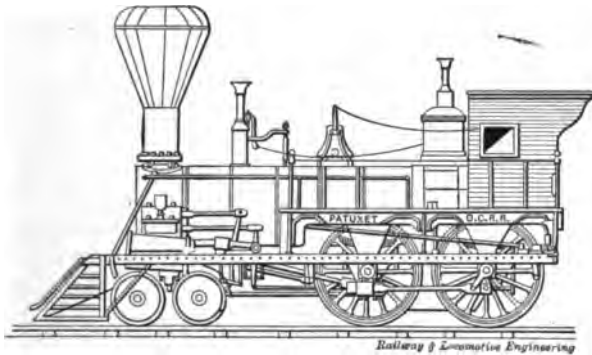

Fig. 101. Old Colony Engine, "Patuxet," About 1850  
Cylinders, 13 x 18 In.; Driving Wheels, 60 In. Dia.; Weight, About 17 Tons

### Elastic Wheels.

Among the things done by Mr. Griggs which marked the master mind was applying elastic lining between the wheel centers and tires to lessen the rigidity of the shock, an invention that materially increased the mileage of iron tires and might with advantage be used to prevent undue wear of steel tires.

### Invents the Brick Arch.

Previous to 1857 locomotives in New England used wood for fuel, and the price became so high that the roads must find a substitute or go out of business.

The inventive workers of the country labored on producing smoke preventing furnaces and boilers, but most of the productions were worthless. Griggs, with the perception of genius,

conceived the idea of an appliance for obstructing the flame on its way to the tubes and produced the brick arch.

Soft coal was tried on a locomotive, 16x20 inch cylinders, 5½ foot driver, and it was a success the first day. A shelf of cast iron was placed across the furnace under the tubes and filled with fire bricks; not being very durable, an arch of fire bricks, 24x4x8 inches, was substituted. This was soon replaced by the brick arch as it is used to-day.

#### **Invents the Diamond Stack.**

The chimney used at first was the old wood burning arrangement with a coarser netting, which was soon followed by the diamond chimney, an invention of Mr. Griggs and one that has been applied to more locomotives than any other improvement of draft appliances. The grates were made to rock and dump.

The first cars were on four wheels with doors at the sides. Later, frames were made, two of the short bodies placed on the frames, a four-wheel truck put under each end, making an eight-wheel car. This was soon followed by the modern car.

When the Taunton Locomotive Company commenced business they followed close after the Boston and Providence pattern of locomotive for several years; Hinkley & Drury did about the same thing.

#### **George Richards.**

For most of the foregoing data relating to Mr. Griggs I am indebted to Mr. George Richards, who was long known to railroad men as master mechanic of the Boston & Providence Railroad, but he had a peculiar career, even for a pioneer railroad mechanic. He went to the road in 1849 as a machinist, then he was a fireman for a short time and was soon advanced to be engineer, a position he held over five years. From that he was advanced to be foreman in the machine shop. While in that position the telegraph was introduced, and nobody at the station being able to operate the instrument, Mr. Richards learned telegraphy, and held the place of telegraph operator for several years. After that he returned to the shops as general foreman and on the death of Mr. Griggs in 1870 was made master mechanic and remained in that position until after the railroad was absorbed by the Old Colony System. Mr. Richards is now (1907) spending his days in comfortable retirement in Roxbury, Mass.



### The Work of Wilson Eddy.

Another New England master mechanic who became celebrated for his work on the improvement of the locomotive was Wilson Eddy, whose name is associated with the motive power of the Boston & Albany Railroad. He was born in 1813 and served his apprenticeship as a machinist in the noted Lowell Machine Shops, successors to the Locks & Canal Company, where he worked on building some of the engines already described. While there he worked on the first iron planers built in this country.

Major Whistler, the celebrated pioneer railroad engineer, had charge of the Western divisions of the Boston & Albany



Wilson Eddy

Railroad, then known as the Western Railroad. In 1840 he employed Wilson Eddy as foreman of the Springfield shops, and the latter soon displayed engineering ability of first-class order.

The road used mostly the English type of engine, built by the Lowell Machine Shops Company, but they also had eight Winans engines, Fig. 103, with upright boilers, the machine being something of the "crab" type, but eight wheel connected.

### The Addison Gilmore.

In 1849 Mr. Eddy drew the plans for his first engine, but the facilities for doing the work of locomotive building being

very meager, the engine was not finished until early in 1851, time enough, however, to be in good working order when the Lowell contest of locomotives took place. This engine was called the "Addison Gilmore," after the president of the Western Railroad. As originally built, the engine had a single pair of driving wheels, 6 feet 9 inches diameter, a four wheel truck in front, and a single pair of trailing wheels under the foot plate. The cylinders were  $15\frac{3}{8} \times 26$  inches stroke, and the weight when working was 51,000 pounds.

Up to this time that Eddy built his first engine, the locomotive builders of New England were noted for the small fire boxes and grate area provided for their engines, from 7 to 9 square feet of grate being the common practice. Eddy provided

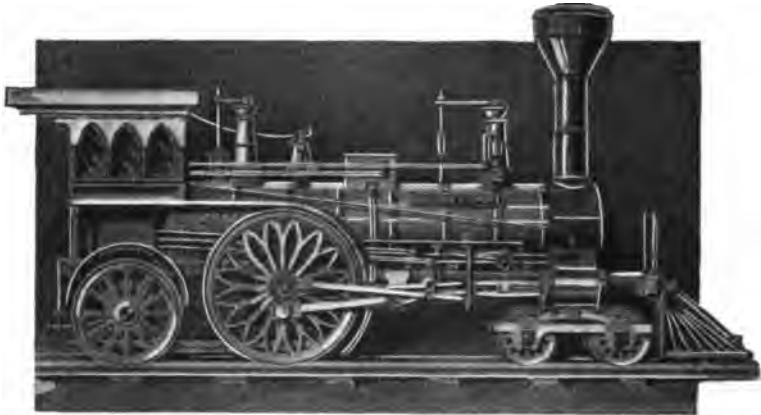

Fig. 102. "Addison Gilmore," Eddy's First Engine, 1851

the Addison Gilmore with  $11\frac{1}{2}$  square feet of grate area; there were 68 square feet of heating surface in the fire box and 1,107 in the tubes, of which there were 196, 12 feet 4 inches long and  $1\frac{3}{4}$  inches diameter. The total heating surface was 1,175 square feet, which was up to modern practice in ratio of cylinder contents to heating surface. A single exhaust pipe was used with a single nozzle,  $3\frac{1}{4}$  inches diameter.

### Better Proportions.

The advanced ideas of Mr. Eddy may be judged from the comparison that the "Antelope," already referred to as a noted engine built by Hinkley & Drury, in 1845, with driving wheels

6 feet diameter, intended to pull the fastest trains of the period, had only 8 square feet of grate and 300 square feet of heating surface to generate the steam required by cylinders 11½ inches diameter and 22 inches stroke.

The Addison Gilmore had horizontal cylinders outside of the frames, being the first engine so built. One of the most notable improvements introduced was spliced frames, which effected great saving in making repairs. This improvement has been credited to William Mason, but Eddy's engine was built two years before Mason commenced the business of locomotive building. While Eddy arranged his cylinders level, he did not spread the truck wheels to make room for them, but placed the cylinders high enough to clear the truck wheels. I believe that

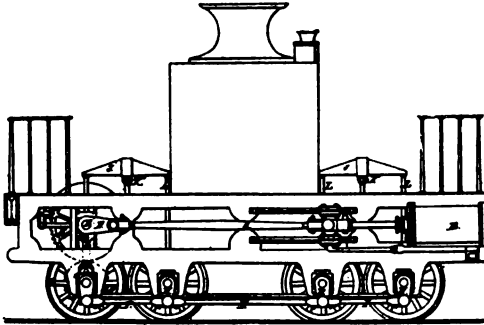

Fig. 103. Ross Winans Engine, for Western Railroad of Mass., 1843

Mason was the first to spread the truck wheels to make room for the cylinders, but Eddy had moved in that direction.

#### Single Pair of Drivers a Failure.

The arrangement of a single pair of driving wheels with a pair of trailing wheels behind did not work any more satisfactorily in Eddy's design than it did with Baldwin, Rogers, Hinkley and others, and after a brief period of service, a pair of driving wheels took the place of the trailers. No cab was put on the engine at first, as there was a prejudice in New England at that time against covering in the enginemen. Oil cups were placed on the boiler head for lubricating the cylinders, and pipes led from them to the top of the steam chest, that being the first case where such a convenience was provided.

The boiler was straight and had no dome, the steam being conveyed through a perforated dry pipe. The throttle was a plain slide valve located in the T pipe in the smoke box, the operating rod extending through the dry pipe to the back boiler head. The slab frames used back of the front driving wheels were bolted to the side of the fire box, the expansion being provided for by movement at the cylinder connections. This arrangement made room for a fire box about three inches wider than that of engines having bar frames.

### Influence of Eddy's Work.

Eddy built many locomotives during the forty years he was with the Boston & Albany Railroad, and the Eddy Clocks, as



Fig. 104. "New England," Old Taunton, 1860

his engines were popularly called, were held in high esteem, even affection, by enginemen, and never were beaten for efficiency and economy. A peculiarity about all Eddy engines was their short steam ports, which were only 8 inches long for cylinders  $18\frac{3}{4} \times 28$  inches.

Decided difference of opinion now exists concerning the influence of Eddy's locomotives on the motive power of this continent. One thing is undeniable—he made engines convenient to operate, easy to repair and so proportioned that maximum wear was secured before heavy repairs were neces-

sary. As we examine the locomotives built between 1850 and 1860 when something approaching uniformity of appearance had been reached, we are moved to believe that the influence of Eddy and of Mason was far reaching.

The illustrations in this chapter fairly represent the trend of locomotive designing in New England up to the sixth decade, when the smaller size of the modern engine was coming into general use.

### Triumphs of Manipulative Skill.

The small locomotives built by the pioneer master mechanics were wonderfully durable machines and represented highly developed skill on the part of mechanics, for they had very little

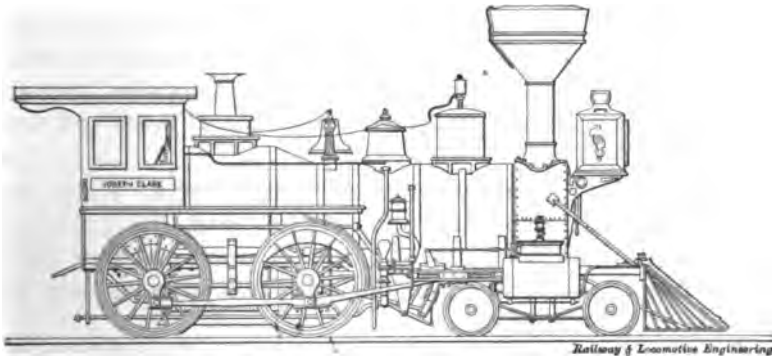

Fig. 105. Famous Morrill Engine, Built by Vermont Central Railroad About 1863  
From drawing loaned by R. E. Russell, Burlington, Vt.

help from the tool makers' art. The double crank axles used so much were turned from a very rough forging on a lathe with a wooden bed on which accurate work depended entirely upon the skill of the machinist. But the workman of the day had perfected his art.

The driving wheels were bored on another lathe of similar construction, being fastened to the face-plate by means of a wooden chuck with straps and bolts. Before being removed from the place where they were bored, the keyways were splined with a tool fixed in a bar attached to the footstock spindle, forced forward by a screw.

There were then no hydrostatic wheel presses, and the wheels were forced on the axles by long bolts and nuts passing through heavy straps outside the wheels. If the force thus ap-

plied was not quite sufficient, a few blows from a 50-pound sledge were found to help. Keys of best cast steel were fitted to drive with all the force they would sustain to make loosening of the wheel impossible. The crank pins were forced into the wheels in a similar manner and were riveted in.

The frames of engines built by Hinkley & Drury were made of three bars of iron. Two of these were about 4 inches wide and  $\frac{1}{2}$  inch thick; the other was perhaps 2 inches square. The three were riveted together to form a kind of channel bar, which was placed open part below. The " housings " for the driving wheel boxes, which were of cast iron, were flanged to fit the channel bar and were riveted in place. The boilers were riveted, chipped and caulked by hand. The flanging of the fire box and other sheets was performed by hammers and swedges over cast iron forms. There were from 80 to 120 copper flues in the boilers. These were at first made of sheet copper, cut in strips formed into a tube and the joint brazed. Afterward, perhaps about 1852, seamless drawn tubes were made of brass and were extensively used.

To put the driving wheels under the erected boiler and frame was half a day's work for several men, the appliances being a cord (more or less) of blocks of wood and four screw jacks. It was possible to get along with two jacks, as only one end was raised at a time.

Every piece of the engine was required to be made in the best manner possible; all parts fitted together were required to "drive" and all screws and nuts to "wrench."

With the accurate tools of the present, it is easy to accomplish this, and also to duplicate the parts. But in those days no such tools were or could be made, and uniformity was not attempted. The parts were fitted together by hand, and marked with figures as they should go, and trouble came to him who attempted to put them together otherwise.

### Conditions Against Railroad Mechanics.

Although the first two decades of railroad operating in New England developed two or three conspicuously able master mechanics, their successors seldom rose above mediocrity. They were good mechanics as a rule, and repeated the designs that came to them; but the profusion of contract building establishments tended to deprive the men in charge of railway ma-

chinery of opportunities for demonstrating the ability they possessed, as the railroad managers preferred purchasing to building locomotives.

### Cephas Manning.

A New England railway master mechanic who attained celebrity in the railroad world was Cephas Manning, who began locomotive work in the Essex Machine Shop, Lawrence, Mass. Manning went West about 1855 and was appointed master mechanic of the Louisville, New Albany & Chicago Railroad. This was before Greeley gave his famous advice "go West, young man," but many young mechanics of New England were anticipating the advice about 1855 and going West, where many of them became leaders in their line.

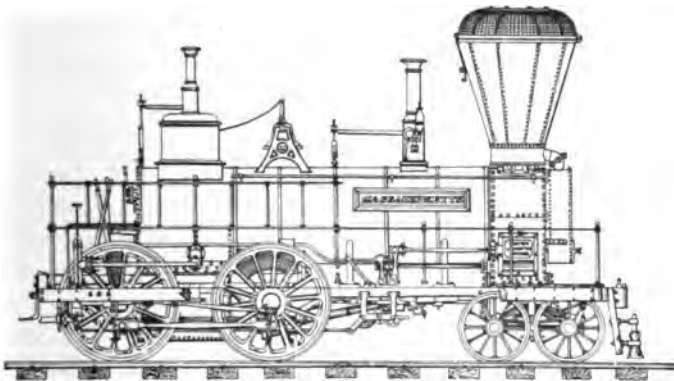

"Massachusetts," Built by Hinkley & Drury, About 1850, for Philadelphia & Reading.  
Cylinders, 15x 20 Inches; Drivers, 54 Inches Diameter

Manning remained on the New Albany road just long enough to make his mark, when he was appointed master mechanic of that part of the New York Central Railroad west of Albany. There he became noted for the efficiency of the locomotives he designed and built.

### John Thompson.

John Thompson, whose railroad career was associated with the Eastern Railroad of Massachusetts, now part of the Boston & Maine system, began work on that road as a machinist in 1848, and, except for a few years passed in Cuba, was with the

same company till 1877, most of the time as master of machinery.

Mr. Thompson, who is still alive, claims that he was among the first to break away from the crude and defective methods of putting work together. He abandoned the practice of splining and keying of wheels and axles, the bolting and riveting of driving wheel tires, which, instead of making them safer, as was supposed to be the case, reduced the factor of safety. For splined and keyed eccentrics, he adopted the solid form, held by set screws. He was the first in New England to use Vicer's cast-steel tires, and brought much criticism upon himself for this act of progress. When coal took the place of wood as fuel he perceived that something was necessary to keep sparks from being thrown upon the train, and decided that an extension front end was the proper thing, and applied it to all the engines under his charge, an invention that has become common the world over.

### **John P. Laird.**

A locomotive celebrity who worked on New England railroads and locomotive building shops was John P. Laird, who afterwards gained worldwide note as chief mechanical engineer of the Pennsylvania Railroad. Mr. Laird learned the machinist trade in Scotland and came to this country when he was 19 years old. After working a short time in the Rogers Locomotive Works he went to the Ballardvale, Mass., locomotive shops. Shortly afterward he began his railroad career on the Northern Railroad of New Hampshire, where he worked in the shops, then ran a locomotive. Mr. Laird went and ran an engine on the Michigan Central Railroad, but later returned to New England and took charge of the A. Latham & Co. locomotive shops at White River Junction. While there he superintended the construction of the "Gladiator," which went to the Chicago & Northwestern Railway and was celebrated as one of the most efficient passenger engines in the West. About 1860 Mr. Laird was appointed superintendent of machinery of the Pennsylvania Railroad, where he made his mark as few engineers have been privileged to do.

### **William Bullock.**

One of the pioneer master mechanics of the Old Colony Railroad chartered in 1844 was William Bullock, who was a



man of advanced ideas. He made use of a swinging truck before Bissell patented that invention, a fact which was brought out in a lawsuit by the Safety Truck Company against the Pennsylvania Railroad in 1880. He experimented considerably with smoke preventing devices for burning soft coal and introduced what was known as the sub-treasury, set near the smoke box to collect sparks.

### **James Lauder.**

Of the Northern New Hampshire and later of the Old Colony Railroad, labored with some success to improve the valve motion. He was the first to locate the rocker shaft ahead of the guide yoke which was done to admit of longer eccentric strap blades. He also helped to introduce balanced valves, and helped to improve the wagon top boiler.

### **Aretas Blood.**

A locomotive builder who was quite famous in New England was Aretas Blood, who became the principal owner and manager of the Manchester Locomotive Works. Blood engines were famous on several western roads during the 60s. Blood was a machinist in the Essex Machine Shop and pushed along to be manager of the contract work, where he saved enough money to enable him to purchase the large interest in the Manchester Locomotive Works.

### **Fine Work and Long Hours.**

The mechanics of the early New England locomotive works were noted for the fine work they produced with inferior tools and also for the long hours of labor, 12 hours a day being common. In 1852 John Souther & Co. reduced the working hours of their shops to ten hours and a demand at once was made by the workmen in other establishments for similar reduction of working time. Hinkley's people resisted the demand and a strike ensued which was the means of bringing all the employers to terms.

It may be of interest to note here that Zerah Colburn, the famous mechanical engineer and technical writer, was for several years chief draftsman for John Souther & Co.

### **American Railway Master Mechanics.**

The pride and glory of the railway master mechanic came to be in maintaining the power at the highest possible efficiency

and doing repair work in such a shape that a rebuilt engine was as good for hauling trains as it was when new. The master mechanics of New England, and in fact all over the American continent, displayed much intelligence in adopting improvements no less than in rejecting worthless fads that were constantly urged upon their attention. No real improvement that came to be a recognized attachment of a locomotive was ever laid aside long through the conservative tendencies of these officials. They did their work well and faithfully and deserve a full meed of praise.

### Locomotive Races.

About the time that locomotive building became most active in New England great rivalry arose among the different makers and railroad master mechanics as to which make of engine was

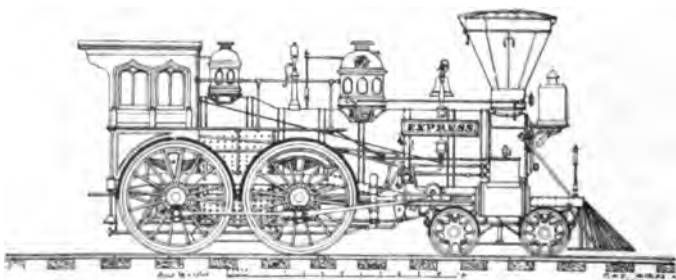

Fig. 106. "Express," Boston & Worcester, Built in Company's Shops from Designs Furnished by A. S. Adams, Master Mechanic

the most efficient. A belief arose and spread that the proper way to settle the question was to hold a race where rival makes might display their speed capabilities. The test of racing was worth nothing, any more than the racing of automobiles is today, but the railroad officials of the time took it so seriously that the New York Association of Railway Superintendents arranged for a contest of locomotives to demonstrate both speed and hauling power. This extraordinary event took place on an unused portion of the Lowell Railroad belonging to the Boston & Maine system in October, 1851. The distance run was 8 miles 36.16 feet. A committee consisting of scientific and practical men was in charge.

The American Railroad Journal, February 14, 1852, gives the following account of the competition as being the committee's rules and findings:

"The trial of locomotive engines for speed and draught was held on a piece of unused track belonging to the Boston & Maine Railroad, and under control of the New York Association of Railway Superintendents.

"The rules adopted were:

"First.—That all engines upon this trial should carry the same load over the same distance.

"Second.—That the pressure of steam in the boilers should not exceed 120 nor be less than 70 lbs. per square inch.

"Third.—That the pressure at starting should be taken as the pressure at which the engine worked over the whole distance, the safety valve balances remaining unaltered.

"The constant load in the trial of speed consisted, besides the tender, of six covered freight cars, each loaded with five tons, one long passenger car and twenty-one passengers, the whole weighing 85 tons.

"The report shows we have confidence that equal justice has been done to all, with exception of the Addison Gilmore, of the Connecticut & Passumpsic River Road.

"This engine was worked at a much higher pressure than the others and would, under the circumstances, have had a decided advantage, but as she had just come from the shop and never had been attached to a train, it is difficult, if not impossible, to arrive at a correct estimate of her power as compared with the others, to which is to be added the consideration that she was worked at a pressure above that proposed by the committee's rules.

"The Dedham, a small tank engine, built by G. S. Griggs for the Boston & Providence Road, was run over the same track on the day after the trial of the other passenger engines, with a load of two passenger cars and 81 passengers, making the entire weight 18 tons.

"The time in which this engine passed over the nine miles is given in detail with the others, but with such disproportionate load, we think it inexpedient to make any comparisons.

"The trial of the freight engines was made upon the track connecting the Boston & Maine Railroad at Wilmington, over a distance of 9,100 feet in length. The load consisted of 114 loaded cars, estimated to weight, cars included, 650 tons.

"Each engine first backed its train down to the starting point, which was at the top of an inclined plane of 14 feet to the mile, and from this point was started at a given signal, mak-

ing their best time to the point at the other extremity of the course.

"The time of the passenger engines was:

	Weight, Pounds.	Time.
Neponset .....	43,775	13 min. 25 sec.
Nathan Hale .....	47,093	12 min. 30 sec.
Addison Gilmore .....	50,885	11 min. 29 sec.
Union .....	46,320	13 min. 28 sec.
Addison Gilmore M.....	46,320	14 min. 25 sec.
Essex .....	48,470	14 min. 33 sec.

"The time made by the freight engines was as follows:

	Weight, Pounds.	Time.
Milo .....	38,900	10 min. 24 sec.
St. Clair .....	48,650	10 min. 54 sec.
Highlander .....	40,015	12 min. 38 sec.

"Of the passenger engines, the first medal was awarded to the Addison Gilmore, of the Western Road; the second, Nathan Hale.

"Of the freight engines, the first was awarded to the Milo; the second to the St. Clair."

The Lowell competition was a proceeding emanating from good intentions that proved of no value, as generally results with competitions of things mechanical.

### New England Locomotive History.

I have pleasure in adding to this chapter an article contributed to Railway and Locomotive Engineering by W. A. Hazebon, of Boston, which was received after this part of the book was on the press.

The accompanying table of motive power of the Old Colony Railroad in 1849 is probably one of the oldest extant and furnishes details of historical interest which entitle it to a prominent place among the old timers brought to light in the research of recent years. As will be noticed by examining the list, the Gov. Bradford (Fig. 107), Gov. Carver and Miles Standish were of similar weight, dimensions, etc. These were practically the pioneer locomotives on the road, having been preceded a short time only by the English engine "Comet," which was brought from abroad and delivered at an old wharf in Plymouth, Mass., the Southern terminus of the road. No dimensions or statistics were recorded regarding this engine, and in 1852 it was sold to-

gether with the Gov. Carver. Most of the locomotives named on this early list were from the famous Hinkley & Drury shops, Boston. The Hingham was from the Springfield Mfg. Co., the Weymouth and possibly the Abington were built by Jabez Coney, whose foundry was located in close proximity to the original Old Colony roundhouse.

#### Old Colony Railroad—Table of Motive Power, 1849.

Name.	Wheels.	Weight.	Cylinder.	Miles run.
Dorchester .....	12	53,300	16x20	13,703
Plymouth .....	12	56,400	16x20	2,373
Kingston .....	8	36,500	14x18	19,245
J. Q. Adams.....	8	41,600	15x20	21,286
May Flower .....	8	44,600	15x20	14,167
Patuxet .....	8	34,800	12½x20	15,579
Abington .....	8	38,500	14x18	19,837
Weymouth .....	8	39,000	14x18	27,389
Hingham .....	8	40,650	14x18	15,200
Quincy .....	8	36,900	12½x20	12,410
John Eliot .....	8	36,950	14x18	16,910
Gov. Bradford .....	6	26,500	11x20	18,995
Gov. Carver .....	6	26,500	11x20	16,058
Miles Standish .....	6	26,500	11x20	21,844
Comet—A light English engine.				

The Plymouth and Dorchester were built by Seth Wilmarth, but evidently did not survive long as twelve wheelers, later lists referring to them as eight wheelers. The locomotive works of John Souther were located in South Boston in these days and the old Mayflower was a product of that concern.

Anecdotes of interest could be related in connection with nearly all of these early locomotives. In 1848, when the remains of John Quincy Adams were borne from Boston to their last resting place in Quincy, the old locomotive J. Q. Adams hauled the funeral train.

The famous old Patuxet (Fig. 101) holds a place in locomotive history of more than ordinary interest. A photograph and description of this engine appeared within recent years in the columns of *Locomotive Engineering*, so that further remarks would be superfluous, but it may be stated that Mr. George Duckworth, of Bridgewater, Mass., who for years ran the Patuxet, is still living.

and in January, 1906, celebrated his 88th birthday. He followed railroading for 60 years and was the first engineer to take a train from South Braintree to Fall River on the then new line. Mr. Duckworth was born in England but came to this country at the age of ten and lived in New York City for a number of years. He joined a band there and had the distinction of having played at the inauguration of President Andrew Jackson. One of Mr. Duckworth's sons is an engineer on the New York, New Haven & Hartford. The old Patuxet was the first eight wheeler owned by the Old Colony, she was numbered 3 and was retired from service in 1879 or thereabouts. The ancient name which, by the way, was the original name of the town of



Fig. 107. "Gov. Bradford"

Kingston, Mass., was abandoned with the passing of the old machine.

The locomotive John Eliot was purchased from the Old Colony some time in 1854 by Mr. Joseph Taney, of the Bangor, Oldtown & Milford Railroad. Mr. Taney was, at that time and during his whole life thereafter, employed by General Veasie, owner of the Bangor, Oldtown & Milford, in the capacity of civil engineer and superintendent. The John Eliot was used on this road until the fall of 1870, when the road was purchased by the European & North American Railroad. The latter being broad gauge at that time, the old engine was taken up and transferred

to the roundhouse in Oldtown, where it remained until September, 1878, at which time the European & North American was changed to standard gauge, when this engine was again put into service, remaining until the road was absorbed by the Maine Central in October, 1882, after which time it was dismantled and used to furnish steam for pumping water at Oldtown. The ancient boiler was finally cut up in 1894, thus ending the career of the oldest survivor of the Old Colony pioneers.

At the time of the civil war the Old Colony locomotives hauled thousands of brave men to the southern battle fields, and when finally the government called for locomotives, patriotism furnished all the worn-out or doubtful specimens that could be spared, for which the companies received liberal compensation. The Job Terry, Speedwell and Dorchester were the ones "sacrificed" by the Old Colony to "go to the front." The next thing to do was to restock, and this proved a harder matter as the increase in transportation created a lively demand for rolling stock and the building shops were overrun with orders. Added to this came the consequent rise in prices and the heavy premium on gold, and some roads were at their wit's end to find motive power for their business.

It was at this time that the Old Colony purchased the famous Electric from the Manchester Locomotive Works for a sum rising \$27,000, and then the company was offered a bonus to take it off their hands. One or two second-hand engines were bought and finally the company took a number of "scrap heaps" that had been purchased for junk by "Yankee Leonard," a noted scrap buyer of those days. These were repaired and used for some time to tide over with. Years after the war the names Speedwell and Dorchester were revived on locomotives built by Mr. J. K. Taylor at the Old Colony shops in South Boston. Mr. Taylor came to the Old Colony from the Manchester Locomotive Works in 1871, succeeding Mr. W. H. Bullock as master mechanic, the latter becoming superintendent of the road. During Mr. Taylor's regime many new engines were built in the company's shops, among them being the then well-known but now nearly-forgotten Royal Turner, Pilgrim, Newport, Falmouth and Bristol. In 1884 Mr. Taylor became superintendent of rolling stock for the Boston & Lowell Railroad, continuing in this capacity until the road was leased to the Boston & Maine, when he resumed his connection with the Manchester Locomotive Works. He was compelled by ill health to resign and retired to his home in Nepon-

set, Mass., where he died February 28, 1905, after a long and painful illness.

Until it ceased to exist, the historical idea in the locomotive names as illustrated in the primitive list was faithfully adhered to by the Old Colony people and that the carrying out of the traditions of early days was appreciated by the patrons of the road goes without saying. For some time after the road was absorbed by the larger company the equipment was assigned to a group of numbers which rendered possible the identification of many of the old timers or their successors, but within a few years a general rearrangement of numbers has taken place doubtless for classification purposes, so that the last faint connection with the past has been obliterated.

The Gov. Bradford would appear as a mere toy if placed beside the smallest modern locomotive which to-day thunders along the highways of steel where once the product of the early builders puffed along in laborious fashion. The photograph was taken some months before the engine was retired from service late in the seventies, and it is hoped that its appearance at this time will serve as a welcome reminder of bygone days.



# Troublous Times in Railway and Locomotive Construction

## CHAPTER XV.

### A Critical Period.

The first decade of railroad history was one of the most critical periods the United States had passed through. It opened up with the people unusually prosperous and with

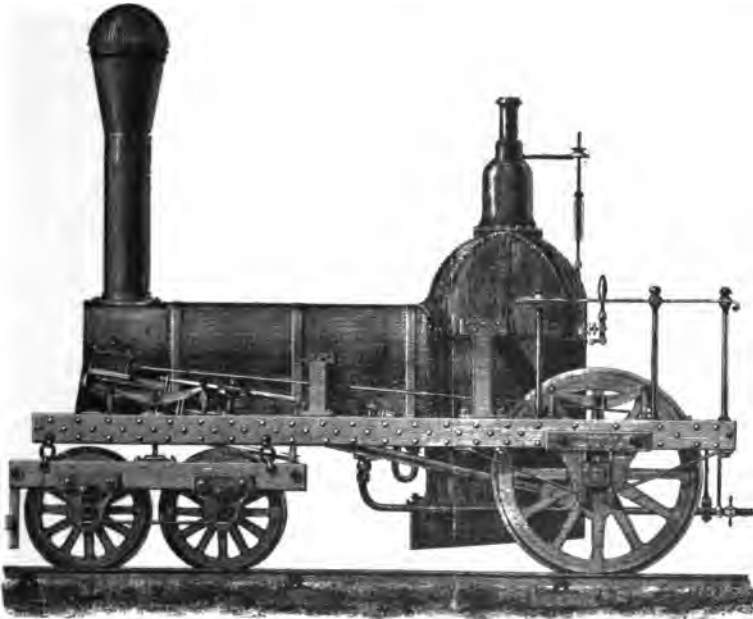

Early Norris

money to devote to internal improvements. In 1833 President Jackson ordered an accumulation of money stored in the United States Bank, amounting to forty millions of dollars, a vast sum of money for those days, to be distributed among State banks. These banks loaned the money, so unexpectedly obtained, on all kinds of doubtful securities, and a wild season of speculation arose. The purchase and sale of lands belonging to the public domain was the principal object of speculation and incidentally

the construction of railroads was worked up to a highly inflated degree.

### A Railroad Mania Pushes Railroad Construction.

A decided railroad mania prevailed, which was overtaken by the inevitable panic in 1836. In 1830 there were 23 miles of railroad in the whole of the United States.

The following table shows the mileage of railroads in operation or under construction in the different States in 1836:

	Miles
Alabama, under construction .....	62
Delaware, in operation .....	17
Georgia, in operation .....	12
Kentucky, in operation .....	85
Louisiana, in operation .....	5
Maryland, in operation .....	144
Maryland, under construction .....	70
Massachusetts, in operation .....	72
Mississippi, in operation .....	26
New Jersey, in operation .....	105
New York, in operation .....	70
New York, under construction .....	200
Pennsylvania, under construction .....	234
Pennsylvania, in operation .....	392
Rhode Island, under construction .....	46
South Carolina, in operation .....	136
Virginia, in operation .....	195
Virginia, under construction .....	86

These figures show that nearly two thousand miles of railroad had been built in six years, a most extraordinary achievement for a new country that was chronically so short of capital for carrying on legitimate enterprises that the practice of barter prevailed largely between seller and buyer.

### Railroad Mileage Exceeds the Necessary Power.

The progress of railroad building in the United States, as compared with that of Great Britain, conveys a good idea of the energy displayed by American public men in pushing improved methods of land transportation. In 1840 Great Britain, with what was then unparalleled financial resources, had 3,430 miles of railroads and the United States had 2,755 miles. For this mileage, the United States however had only 270 locomotives, the small amount of

motive power being due in some measure to the high price of locomotives and difficulty in obtaining them. A considerable part of the mileage was operated by horses, which were the first form of motive power used, and they were slowly being pushed aside by the locomotive, just as they have of late been pushed aside in street car service by electric traction.

### **Railways Cease Locomotive Building.**

During the first two decades of railroad operating in the United States there was a tendency among a few leading railroad companies to build their own locomotives, but that practice was gradually abandoned and the contract locomotive builders became the recognized authorities, not only for building, but also for designing the motive power. Great rivalry existed among them, principally as to which establishment could build the best engines, a form of emulation which militated very much in promoting the interests of their customers.

### **Railroad Industrial Policy.**

Certain conditions connected with railway management in the United States have prevented the companies from establishing plants for the construction of their operating machinery so common in other countries, and the malevolent conditions tended to suppress the railroad building shop before the first locomotive built in the country was twenty years old. This is known as the Wall Street influence. The way it has worked throughout the whole of our railroad history has been to stop the expenditure of every dollar that could be kept in the treasurer's hands as soon as the least trade depression appeared. This policy tends to turn slight depressions of business, such as a bad harvest, into real hard times. Doing new work is the first thing stopped, with the consequence that skilled labor could not be kept ready to resume operations when the clouds had rolled by. That is the railroad industrial policy of to-day with a few exceptions.

When we consider that railroad operating suddenly created a demand for cars, locomotives and other machinery that could be made only by skilful mechanics, the wonder grows that a community largely agricultural was able to supply the demand. The misfortunes of the country helped the people in this crisis.

### **Misfortunes That Were Disguised Blessings.**

Owing to the tyranny and unscrupulous policy of the British Government in exercising the right to search American vessels on

the high seas, or anywhere else where might could be converted into right, the feeling of hostility raged so fiercely in the United States that in 1806 Congress passed an act prohibiting the importation into the United States of many important articles of British manufacture. This was followed shortly afterwards by a British Government order forbidding intercourse with France and other interference with commerce arose so that for about ten years the United States was, to a great extent, bottled up from European trade intercourse. During that period many American farmers, lumbermen and laborers were converted into mechanics.

Men of that training did the mechanical work upon the steamers that arose upon American waters at this time, and they were equal to meeting the revival of industrial activity introduced by Ely Whitney's invention of the cotton gin. The sons of those men were ready to build locomotives and cars when their labors on such work came into demand.

#### **First Locomotive Builders.**

Baldwin, Norris, Eastwick & Harrison were the first builders of any consequence in the business. Gillingham & Winans had rented the Baltimore & Ohio shops, at Baltimore, and were building locomotives by contract, but most of their output went to the Baltimore & Ohio Railroad. The Locks and Canals Company, Lowell, Mass., had begun building locomotives in 1834, and were doing a small business, most of their output being close imitations of R. Stephenson & Co.'s "Planet" type of engine. The West Point Foundry Association, of New York, which did the first building of locomotives in the United States, had abandoned the business for what they considered more profitable work. William T. James was turning out an engine of extraordinary design occasionally and various, almost forgotten, concerns were building a locomotive now and again that occupied their capacity the greater part of a year.

#### **The Fascination of Locomotive Building.**

There seemed to be something very alluring about the business of locomotive building in early days. When Mr. Baldwin was wrestling to overcome the structural defects of his first engine, the "Old Ironsides," he is said to have remarked that he would have nothing more to do with locomotive building, but the attractions of the business proved too strong for his resolution, and he returned to the work and was one of the few to make it a magnificent

success. Many others put their hands vigorously to locomotive building, and have left no successor to eulogize their labors, record their difficulties and perpetuate their memories.

As the principal center for the building of machinery at this time was Great Britain, American railroad companies naturally imported from that country the locomotives which they could not have built at home, and there was at first an idea that foreign built locomotives must necessarily be better than the home-made article. A very few years of expensive experience brought foreign built locomotives down to their intrinsic value, which was below that of the engines turned out of American workshops.

### **Aristocratic British Mechanics.**

When the revival of the mechanic industries developed in the latter part of the eighteenth and early part of the nineteenth century, the manufacture of tools and machinery was worked up principally in British workshops and factories. The owners of these places and the mechanics who did the work came to consider that with them resided a monopoly of the skill that could design steam engines and other machines constructed of iron, steel and brass, that demanded true and accurate finish. They had almost a monopoly of this business in Europe, which made them conceive that they were the only people who could do such work, with the result that they became arbitrary in dealing with customers.

### **A Transaction in Axes.**

Early in the nineteenth century lumbering business assumed important proportions in the United States. The English axe used at first was a flat blade, but by some process of evolution the American axe had become a wedge. As the English were the cutlers of the world at that time, the Americans ordered axes of the form they preferred. But instead of the wedge head they always received the flat English axe. Pattern axes made at the cross roads forge were sent over, but all in vain. The Sheffield cutlers assumed to know what was the best form of axe, and Americans, failing to receive what they wanted, proceeded to establish axe-making factories, where the desired pattern was produced. By this means England lost an important article of manufacture.

### **Inconvenient British Locomotives.**

The British locomotive makers were scarcely so unyielding as the axe makers were, but American railroad companies never suc-

ceeded in obtaining from England the form of locomotive they wished to secure. The American locomotive had been developed by men who had much experience running them and were required to do most of the repairing. This training moved them to have everything as convenient as possible for handling on the road and easy to repair. In the first thirty years of the railroad era it is probable that there was not a single master mechanic in the United States who had not at one time acted as a locomotive engineer.

In Europe it was different. There the locomotives were designed mostly by civil engineers who cared nothing about making the engines convenient to operate or easy to repair. This did not suit Americans, and because of the inconvenience of their product, the British locomotive makers lost the American trade, just as the axe makers had done.

### **Shortcomings of British Built Locomotives.**

British-made locomotives were a very short time running on American railroads, before the locomotive engineers began to make unfavorable comparisons between them and those made in the United States. The unique privilege which American locomotive engineers enjoyed for many years, of criticising the designs and working of their engines, soon closed the United States market for British locomotives and stimulated native machine shop owners to enter the field of locomotive construction.

The principal fault found with the English locomotives was that they were inconvenient to handle and to repair, the latter being a very serious objection when the principal part of the repair work had to be done by the enginemen themselves. The annual expense of repairing the Stephenson locomotives on the Liverpool & Manchester Railway was enormous. In 1833 the cost of keeping thirty engines in repair was about \$140,000, and ten of the engines were reported to be useless. As the mileage made by each engine did not exceed 10,000 miles a year, the cost of repairs alone was about 47 cents a mile.

American railroad companies were not disposed to rival that kind of extravagance.

This gave Americans their opportunity, and the forge, the millwright shop, the foundry and the machine repair shop were encouraged in the ambition to become locomotive builders. Many of them succeeded to a limited extent, and numerous graduates from

the cross-roads smithy took the proud position of mechanic in locomotive building shops.

### Americans Built Their Own Locomotives When Possible.

Very reliable evidence of the rapid progress in locomotive building in the United States is preserved. In 1838 an investigation was made by the United States Government into the number of steam boilers in use in connection with steamboats, locomotives and stationary engines, with the names of the makers, the time the boilers had been in service and other facts. This report gave particulars of 1,860 stationary engines, 807 steamboat engines and 345 locomotives. The locomotives were at work on fifty-six different railroads.

The report gives curious evidence of the numerous parties who had been smitten by the locomotive building infection. There had been 271 locomotives produced by American builders and 74 were built abroad.

This was surprising, considering that the report was made only eight years after the first locomotive had been turned out of an American workshop.

The locomotives were built by the following firms:

#### American Locomotive Builders.

Baldwin .....	82
Boyden, S. ....	2
Burr & Co. ....	3
Davis & Gartner .....	6
Dunham & Co. ....	13
Eason & Dotterer .....	7
Garrett & Eastwick .....	8
Gillingham & Winans .....	11
Locks and Canals .....	35
McClurg, Wade & Co. ....	5
McLeish & Smith .....	2
Milldam Foundry Company .....	4
Newcastle Manufacturing Company .....	12
Norris .....	42
Otis, W. S. ....	2
Rogers .....	3
Rockwell, Hicks & Co. ....	9
Sellers & Son .....	2
Smith & Co. ....	2

Stevens, R. L. ....	15
Sumner, Graves & Day .....	1
Walchman & Bratt .....	1
West Point Foundry Company .....	4

---

 271

#### Foreign Locomotive Builders.

Braitwaite & Co. ....	4
Bury & Co. ....	22
English, makers unknown .....	3
Forrester .....	1
Hicks & Co. ....	2
Stephenson & Co. ....	34
Tayleur, C., & Co. ....	5
Young & Co. ....	3

---

 74

Some of these locomotives were built by railroad companies, but the collectors of the data put the names of those who had supervised the construction of the engines. R. L. Stevens, for instance, is representing the Camden & Amboy; Davis & Gartner the Baltimore & Ohio, and so on. Some makers have been omitted, such as the West Point Foundry, but there is no doubt that the report is substantially correct, for it bears the marks of painstaking accuracy.



# Locomotive Building in New Jersey

## CHAPTER XVI.

### New Jersey Convenient Manufacturing Position.

In the early days of industrial development in the United States, the impression prevailed that the seats of manufacturing



Passaic Falls. Greatest Water Power in New Jersey

Photographed by Margaret J. Wilson

industries must necessarily be within easy reach of the ocean and of the natural waterways connecting therewith. Before railroads had come to make States west of the Appalachian Mountains bar-

riers almost as convenient for manufacturing enterprises as Massachusetts, the State of New Jersey occupied a location which gave great advantages in securing the raw material required for manufacturing at low cost of transportation, and also for distributing with ease and facility the finished products of workshops and factories. The State lay in a convenient point between the manufacturing districts of New England and the markets of the South and growing West, while it was in a position to attract all the skilled labor necessary for industrial occupation.

### Helpful to New Jersey.

The prosperity of two great sections of the United States contributed directly to enrich New Jersey. There was much land intercourse between the manufacturers of New England and the cotton and tobacco producers of the Southern States, all of which had to pass through New Jersey, leaving by the wayside toll payments which gave a livelihood to the members of many households.

The stimulation given to industrial business by railroad building activities that began in the third decade of last century, and of steamboat successes begun ten years earlier, led to the starting of various kinds of manufacturing enterprises in many New Jersey towns and villages that were ambitious to change the plowshare to the spinning jenny and loom, to the vise bench and turning lathe. The people of New Jersey took tenacious hold of the new occupations, and locomotive building was among those that for a time became the most famous and prosperous.

### Hard Times.

It was a rather depressing time in the middle of the fourth decade to enter upon new industries, for the country was suffering from a fearful commercial revulsion, due, in a great measure, to the financial policy of President Jackson, whose term of office expired March 4, 1837, the year that Rogers, Ketchum & Grosvenor turned out their first locomotive. There were business failures in New York City in March and April of that year which amounted to over one hundred million dollars, and business confidence suffered paralysis in every State of the Union.

Later on, when railroad securities became the pawn of semi-gambling, railroad companies were always among the first industrial industries to suffer from financial excitement, but in

1837, when nearly all other lines of business were in panic, railroad mileage continued to extend and transportation to increase.

### Paterson.

Paterson, which by natural advantages ought to be the largest manufacturing city in New Jersey, is now a thriving place of 110,000 inhabitants, situated about seventeen miles northwest of New York. As early as 1791 a group of public-spirited gentlemen of New York, New Jersey and Pennsylvania, of whom the leading spirit was Alexander Hamilton, the celebrated statesman, formed



Rogers Locomotive Works in 1837

themselves into a Society for the Promotion of Agriculture, Arts and Manufactures. An offshoot of that society was the "Society for Establishing Useful Manufactures," a concern organized to promote the manufacture of cotton cloth. The leading purpose of this company was to establish a great emporium of manufactures at some spot offering the greatest natural advantages. After exhaustive search and investigation, the company selected the falls of the Passaic River, on account of the magnificent possibilities of water power. The river at the point selected has a fall of about 70 feet. and is during most of the year a heavy body of water. At one time this provided power for 247 undershot water wheels.

### Paul & Briggs.

In those days it took little capital for a few mechanics to associate themselves together and form a locomotive building concern, for few tools were required, most of the work being done by hand. The year before Rogers, Ketchum & Grosvenor began locomotive building a firm known as Paul & Briggs entered the business. About the time their first locomotive was finished the shop they occupied burned down and the few tools they had were destroyed, besides their locomotive. The disaster ended their career as locomotive builders.

### Promoting Manufactures.

The promoters of the great manufacturing enterprise secured a charter for the building of a town which they called Paterson, in honor of Governor Paterson, of the State. The situation was ideal, for the ground was sufficiently undulating for good drainage and a fine farming country extended in all directions.

The form of advertising that announced to all concerned, that the beginning of a great manufacturing city was rising beside the Passaic Falls, was not neglected, and people began to find their way into the place. It was not like the beginning of Rome of old and of many a thriving American city, whose first population was formed of people who had been chased out of law-abiding communities. On the contrary, this town soon began to draw enterprising and skilful mechanics, and the place grew steadily and prospered. Among the mechanics drawn to the town in 1812 was

### Thomas Rogers.

He was a Connecticut man, who had been trained a carpenter. The textile industries of the town had received great stimulus at that time through the war with Great Britain cutting off the supply of foreign made textile goods, and there was remunerative employment for every man of skill and industry.

Mr. Rogers went first to work in Paterson making wooden looms, but like many other skilful carpenters, he soon took up the work of pattern making, and prospered. Being industrious and of frugal habits, he saved money and soon became a partner in a concern engaged in making looms, in which his skill, shrewdness and energy helped to work up a very successful business. In 1832 he

became the leading spirit in a new machine-making firm, which was called Rogers, Ketchum & Grosvenor.

At that time railroad mileage was increasing very rapidly, and locomotives were urgently in demand. Some of the concerns building locomotives were provided with neither tools nor engineering ability for the work, and naturally very inferior engines were offered for sale. The leaders in railway enterprises realized this, and some of them kept urging Mr. Rogers to engage in the business of locomotive building. John B. Jervis and Horatio Allen took the lead in this kind of solicitation and they got others to second their efforts.

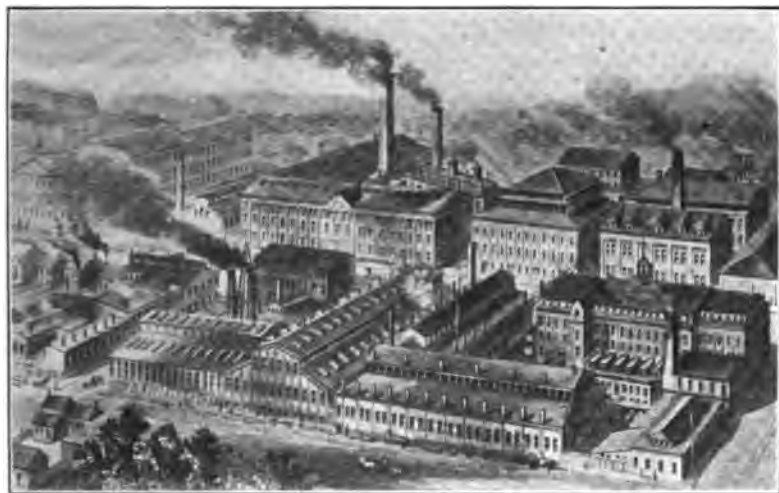

Rogers Locomotive Works, 1907

### Rogers Begins Building Locomotives.

Towards the end of the year 1835 an announcement was published that Rogers, Ketchum & Grosvenor were prepared to receive orders for locomotive engines and tenders, locomotive wheels, axles, springs, etc. They mentioned that the works being extensive and the number of hands employed being large, they were enabled to execute orders with promptness and dispatch.

The firm displayed intelligent enterprise in entering the business of locomotive building. They imported from England a good equipment of machine tools, among them a planer that was then the largest tool of the kind in the United States. The table was driven by a ship's cable chain, but it performed work

which was infinitely superior to the hammer and chisel, the principal cutting tools in most other engineering establishments.

### The Sandusky.

Their first engine, the "Sandusky" (Fig. 108), was not finished until 1837. The engine had cylinders 11x16 inches placed under the smoke box, transmitting the power to the cranked axle of a single pair of driving wheels, which were placed in front of the fire box after the Norris plan. The front end was carried by a four-wheel truck with four 30-inch wheels. Outside frames were used, made of wood sheathed with iron. The ends of the driving

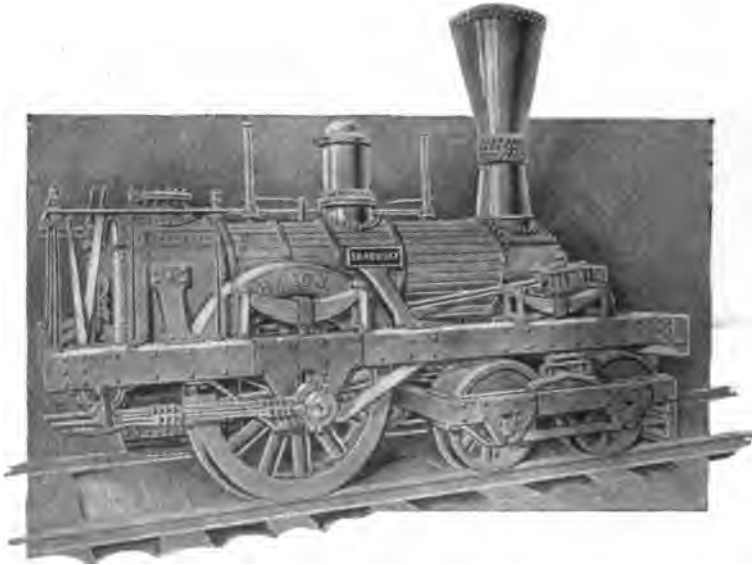

Fig. 108. "Sandusky"

axle protruded through the pedestal and carried the eccentrics and straps, which had rods that extended back and with drop hooks operated rocking shafts that were located under the footboard.

The boiler was peculiar, for that time in the United States, having been straight with a slight wagon top, which was provided with a manhole. There was a dome in the middle of the barrel.

The most peculiar feature about the engine, however, was the driving wheels, which had cast-iron centers with hollow spokes, and the section of the wheels opposite the crank was made with sufficient extra weight to counterbalance the crank and connecting

rod. From the first Mr. Rogers appeared to have recognized the importance of counterbalancing the crank and its connections, but this necessity was not generally appreciated until years after he led the way. It was really the most important improvement that had been effected on the locomotive with a single pair of drivers, although it did not originate with Rogers, Coleman Sellers & Sons having used it three years previously.

The crank axle used by Rogers was peculiar, and was equivalent to the half-crank used by Baldwin, one side of the web being set into the driving wheel, which made room for the crank to work at the side of the fire box. It was an ingenious way of getting around the Baldwin patent.



Thomas Rogers

### **English Influence on Early Rogers Locomotives.**

Two years before Rogers began building locomotives, the Paterson & Hudson Railroad Company received from Robert Stephenson & Co. an engine which had the Jervis truck and a single pair of driving wheels in front of the fire box, to which the power was transmitted from inside cylinders under the smoke box through a crank axle. The boiler was of the form favored by the builders, having a short, shallow wagon top surmounted by a manhole and a dome well forward on the barrel. There is no doubt that the Sandusky was made to closely imitate that engine.

### The Sandusky Goes to Ohio.

About the time that the Sandusky was finished, Mr. J. H. James, of Urbana, Ohio, president of the Mad River & Lake Erie Railroad, visited Paterson looking for a locomotive, and the Sandusky suited him. Mr. Rogers was opposed to selling and protested that the engine was built for the New Jersey Railroad and Transportation Company, but Mr. James would take no refusal, and being a very persistent man, he concluded by shipping the engine by canal and lake to Sandusky. Track laying had not begun when the engine reached its destination, so they built the road to suit its gauge, which was 4 feet 10 inches. The Legislature of Ohio passed a law afterward making the railroad gauge of the State the same as that of the Mad River & Lake Erie Railroad.

### First Railroad in Ohio.

The Mad River & Lake Erie Railroad Company, which transported the first locomotive west of the Allegheny Mountains, was

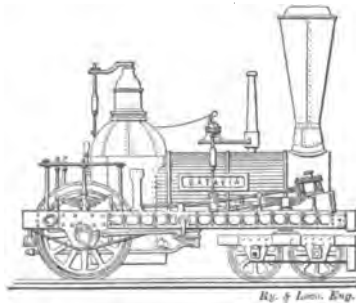

Fig. 109. "Batavia"

chartered in 1832 to build a railroad over the shortest and most direct route between Lake Erie and the Ohio River. The route was followed by the French voyagers in their trading intercourse between Canada and Louisiana.

The route of the line was distinctly specified, and it was provided that the State should have the right to purchase the road after forty years from the time fixed for completion of the work. This was never done. The work of construction was pushed rapidly and the company was fairly prosperous until extensions were undertaken, which led to financial complications. The road is now part of the Cleveland, Cincinnati, Chicago & St. Louis Railway.



Many men who became famous as railroad officials in later years began their railroad career upon what they spoke of fondly as the "Mad River Railroad."

### Rogers Improves the Locomotive.

The first four engines built by Rogers closely resembled the Sandusky, but the fifth one, turned out in 1839, the "Batavia" (Fig. 109), had a Bury hemispherical top boiler. The driving wheels were located behind it, and the rocker shafts were near the middle of the frame, but still actuated by eccentrics secured on the outer ends of the driving axle. With the driving wheels behind the fire box it was discovered that this engine was de-



William S. Hudson

ficient in adhesion and was given to excessive slipping. To remedy this defect an arrangement was provided for transferring part of the weight of the tender upon the drivers.

### Traction Increases.

Traction increasers to perform the same functions as that invented by Rogers were applied to a considerable extent by the early locomotive builders. Engines with a single pair of driving wheels were naturally slippery, and a variety of devices were invented to throw all the weight available upon them.

The first locomotives built by Rogers had not long been in service before the maker became convinced that inside connected engines with the annoying crank axle were inferior in many respects to those with outside cylinders and connections. They were more expensive to build and more difficult to maintain and repair.

The British locomotive builders preferred inside connected engines, because they were reputed to run steadier than those that were outside connected, but Mr. Rogers came to believe that the unsteadiness was due to the want of suitable counterbalancing, and that when this was properly done, outside connected engines would run with as little oscillation as those with cranked axles.

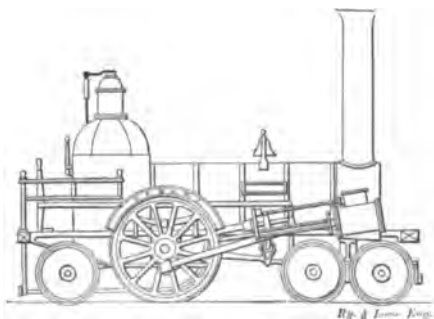

Fig. 110. "Stockbridge"

This conclusion was afterwards admitted by the engineering world to be well founded.

In view of recent construction of locomotives with inside cylinders it is interesting to mention that with some of his ten-wheel inside connected engines Rogers set the cylinders inclined and connected with the second pair of driving wheels. With that arrangement the crossheads passed over the front axle. This plan was adopted for engines built for the Erie and for the Lackawanna. This was done in the early 50s. The same cylinder arrangement was made with an inside connected engine called the Highlander, built by George S. Griggs.

### Outside Connected Engines Popular.

To aid his theories in favor of outside connected locomotives, Mr. Rogers had many object lessons at hand that could not be

ignored. The most popular locomotives at work in 1840 were built by William Norris, and had outside cylinders. Those turned out of the Eastwick & Harrison works all had outside cylinders, and most of the minor builders out of New England followed the same practice. The outside connected engine was much more convenient to get at and to repair than the other kind, and this made them popular with engineers, which counted a great deal in maintaining the popularity of such locomotives.

### Adopts Outside Cylinders.

In 1842 Rogers began building outside connected engines, and he very seldom afterward departed from that practice. His first outside connected engine was the "Stockbridge" (Fig. 110), which had a single pair of driving wheels in front of the fire box, a four-wheel truck under the smoke box, and one pair of carrying wheels under the footboard.

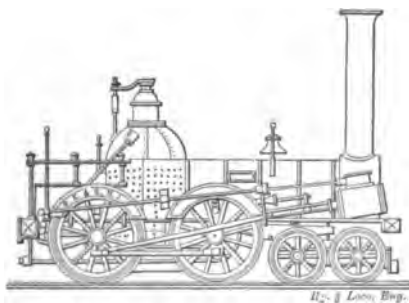

Fig. III. First "American Type"

It was generally acknowledged that American six-wheel engines (single pair of drivers and four-wheel truck) were deficient in adhesion, but both Baldwin and Rogers displayed curious reluctance to employ coupled driving wheels. Rogers' "Stockbridge," with the pair of carrying wheels, brought this difficulty to a crisis so far as the builder was concerned, for the engine was remarkably slippery, and he determined to adopt coupled drivers.

The first engine (Fig. 111) built with coupled drivers was peculiar in some respects. The eccentrics were on the back axle and operated a rocker behind the back drivers, which entailed the use of a tremendously long rod to reach the valve stem. The engine was remarkable in being the first example

of the use of equalizing beams between the driving wheels and truck.

Their first American type of locomotive was built in 1844, and the Rogers Locomotive Works had entered upon the direct line of progress, that by enlargement and adjustment of proportions produced the modern locomotive, with its great variety of types. All the locomotive building works that survived the third decade of railroad operating made progress similar to Rogers and built types of engines that differed very little from those turned out of rival shops.

The head of the Rogers works was very progressive and took the lead in introducing improvements that others regarded with distrust.

#### Introduces the Link Motion.

The shifting link valve motion, as several times mentioned, was invented by William T. James in 1832, and applied to a

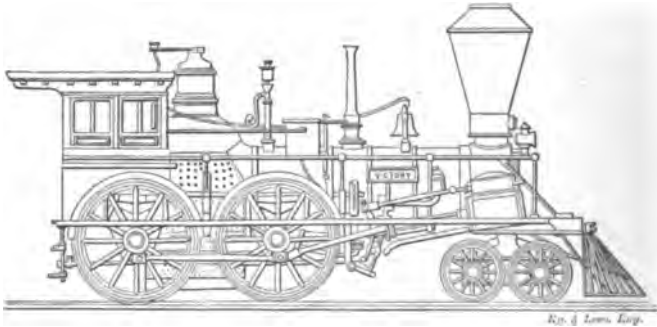

Fig. 112. "Victory," First Engine with Link Motion

locomotive built for the Baltimore & Ohio Railroad. The boiler of the engine exploded and the disaster destroyed the mechanism, so that no proper opportunity was given to demonstrate the value of the link motion, and James did not appear to be greatly impressed with its merits, for in a locomotive which he built a few years later for the Harlem road, he employed a revolving pipe inside of the dry pipe to regulate admission of steam to the cylinders. His fertility as an inventor inclined him to devise new appliances in preference to making the best of those already found practicable.

Ten years after James had tried the shifting link motion, it was reinvented by William Williams, a mechanic in the employ

of Robert Stephenson & Co., Newcastle, and applied to a locomotive under construction for the North Midland Railway. The motion gained popularity very rapidly in Great Britain, and was promptly adopted by all the locomotive builders there. Its praises were eloquently expressed in various publications, but American builders would have none of it until in 1849 Rogers applied it to an engine called the "Victory" (Fig. 112). He soon became a warm advocate of that form of valve motion and his influence was a potent factor in bringing it into general use.

Baldwin had applied a link motion to an engine built in 1845, but he was not friendly to the motion and did not begin applying it regularly until 1854. So to Rogers belongs the credit of introducing the link motion into the United States.



Fig. 113. Hudson's Suburban Engine

### **Applies the Wagon Top Boiler.**

The Rogers Locomotive Works early in their history became noted for doing excellent boiler work, and they always maintained that reputation. They were the first to apply the wagon top boiler, which was done on an engine called the Madison in 1850. That form of boiler soon worked its way into popularity with railroad engineers.

It has undergone no end of abuse, and when considered from a theoretical engineering standpoint has numerous weaknesses, but it is a good boiler to carry steam and water. The strains to which it is subjected are not easily calculated, but the boiler

is the most popular made and has always been in high favor on American railroads.

Thomas Rogers died in New York City in 1856, aged 64 years. He had been engaged in locomotive building for about twenty years, and in that time had done exceedingly valuable work in helping to develop the locomotive on sensible, safe lines. A skilful workman himself, he insisted on first-class work being strictly maintained in the shops he managed. Through this policy the Rogers locomotives early attained a high reputation for efficiency and durability.

### A Chilling Test with English Locomotives.

In 1859 the Southern Railway of Chili ordered from the Rogers Works a freight and passenger engine. At the same time

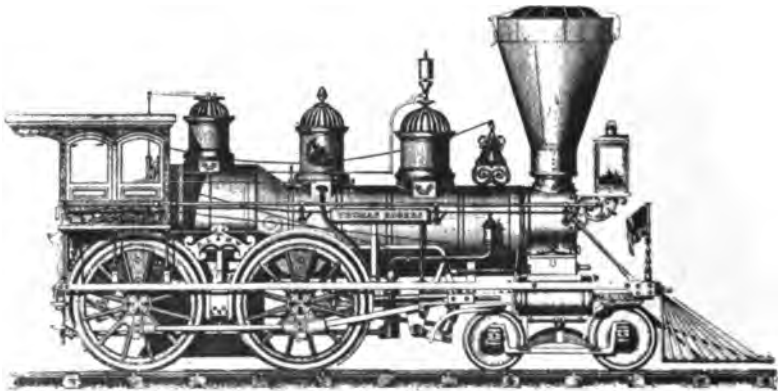

"Thomas Rogers," About 1860

they sent an order to England for similar engines, with a view of testing the different makes to find out their comparative value in hauling trains. The British makers, anxious to do their best, fell into the engineering blunder of making the cylinders too large for the boilers. The American freight engine performed work in forty-one minutes which took the British engine eighty-eight minutes. The Rogers passenger engine pulled a passenger train up a grade in thirty-four and a half minutes, while it took the English engine forty-nine minutes to do the same work.

That test gave American locomotives the preference in Chili for many years.

### Sentiments of Self Help.

That spirit of personal enterprise which has done so much to develop America's natural resources was stirring the hearts of workmen and the sentiment, "Be your own master," was strong in the land, so it was not surprising that other concerns should be established that became rivals to Rogers, Ketchum & Grosvenor. The first of these was known as Swinburne, Smith & Company Works. The leading spirit in the new locomotive works was



William Swinburne

### William Swinburne.

In connection with the successful introduction of locomotive building by Rogers, Ketchum & Grosvenor, one man, whose name is seldom heard in the annals of locomotive building, deserves a great deal of credit. This was William Swinburne, who had charge of the shops when the "Sandusky" was built.

William Swinburne was born at Brooklyn, N. Y., in 1805, of Scottish parents, and learned the carpenter's trade at Matteawan, N. Y. In 1833 he went to Paterson and began work in a millwright shop. When the Rogers, Ketchum & Grosvenor firm was established Swinburne became their foreman and he continued in their employ until about 1845.

About the time the firm decided to begin locomotive building, Mr. Rogers engaged an Englishman named Hodge, who had been recommended to him as a good mechanical draftsman. This man was employed to make the drawings for the Sandusky, and his incompetency almost put a premature end to the business of building locomotives. In making the drawings of the boiler, he blundered so badly that the fire box would not go into the shell. Mr. Rogers was very much discouraged and disgusted, and after discharging the draftsman, he said: "Put away the whole business; we are done with it." Mr. Swinburne, however, expressed the opinion that he could overcome the blunder, and after a time, he was given permission to try. He was advised by Mr. Rogers to go and carefully examine the English locomotive, "McNeil," then running into Paterson. He did so, and after studying the engine carefully, he made the drawings for the new fire box, which proved satisfactory.

Swinburne was one of those versatile men whose services are always invaluable when the introduction of new operations has to be carried out, and who so seldom receive proper credit for the work they have done. Mr. Swinburne was chief draftsman for the firm, principal pattern maker, superintendent of construction and foreman of blacksmith and machine shop. He was for years the only foreman in the place. The shop where the first locomotives were built was 40 by 100 feet, two stories in height. From thirty to forty men were employed, and upon Mr. Swinburne rested the responsibility of keeping the men at work and showing them how to perform new operations.

### Breaking Away from Old Employers.

Owing to dissatisfaction with treatment received from his old employers, William Swinburne determined to enter business for himself, and he was joined by Samuel Smith, foreman moulder of the Rogers Works. Others who had held responsible positions in the old works went along with Swinburne. Thomas Rogers, like many other self-made men, was by no means considerate towards the ambitious aspirations of those who had proved themselves his most valuable assistants. He considered it sufficient that they should enjoy consciousness of the honor that came from working for one who had risen above the mass by native ability.

We read in the Bible that David went to the Cave of Adulam and every one that was in debt and every one that was dis-



contented gathered themselves unto him and he became a captain over them. A modern Cave of Adullam was formed in Paterson in 1845 with William Swinburne as captain of hosts, and they were known as

### Swinburne, Smith & Co.

The "company" part consisted of some of the leading men who had acquired useful skill and knowledge in the Rogers Works, and of James Jackson, a capitalist.

Most of the work they did for the first few years was for the Erie Railway. Their first engine was inside connected with half cranks and in general outline much the same engine as Rogers' Sandusky, but heavier and four wheel connected. There was great demand for motive power for the Erie when this firm was established and they built 39 locomotives for that road in a few years. Of these nineteen were half crank and twenty full crank engines.

### Making and Breaking Reputation of Locomotives.

A good illustration is given in Mott's story of the Erie of how a locomotive engineer could make or break the reputation of a locomotive or even of its builders. In 1850 Swinburne, Smith & Co. delivered to the Erie Railroad engine 71, inside connected, cylinders 17x20 inches, drivers 54 inches diameter. Weight about 53,000 pounds. One engine was assigned to Gad Lyman, who was an admirer of another make of engine and had nothing but evil reports to make about the 71. These were so persistent and the engine lost time with trains so regularly that John Brandt, the master mechanic, assigned the engine to a gravel train.

There was on the road an engineer named J. R. Martin, who had run Swinburne engines and admired their good qualities. He made persistent applications to Brandt for permission to run the discredited 71. The requests were ultimately granted and shortly afterwards the great event of the road came on—its formal opening at Dunkirk by President Fillmore and a distinguished company. Gad Lyman, with the engine which he preferred to the 71, was appointed to run one of the trains taking the guests of the road West. He had to receive assistance to haul the train over an easy division and lost much time. Martin took the same train at Port Jervis with 71 and

pulled it through to Susquehanna, making the best time of the journey.

### **Swinburne As Locomotive Builder.**

After about six years of that servitude which comes from the necessity to co-operate with uncongenial associates and some deficiency of the characteristic represented in the Prince of Wales' motto, *ich dien* (I serve), Swinburne resolved, like Hal O'Wynd, to fight for his own hand. In 1851 he opened a shop for himself at Sandy Hill, close to the Erie tracks and across the street from the present station. Swinburne seems to have profited by the change, for he worked vigorously into a fine business of building locomotives. One of the first orders which he secured was from the Delaware, Lackawanna & Western Railroad. On that he built two engines, the "Keystone" and the "Cayuga," which were very popular.

The most important order received by Swinburne was to stock the Chicago & Alton Railroad with locomotives, which formed the foundation of an excellent business. The Chicago & Alton management were curiously conceited in those days and advertised theirs to be the only first-class railroad in the West, so some of their glory was reflected upon their motive power. The Swinburne engines were certainly good and their reputation spread all over the railroads in the western country.

With the propitious start made, William Swinburne was on the high road to fortune when the commercial panic of 1857 devastated the land like a cyclone, and he went down to ruin with a multitude of other unfortunates.

### **New Jersey Locomotive & Machine Works.**

About the time that Swinburne began locomotive building, another concern came into activity in Paterson, called the New Jersey Locomotive & Machine Works, with John Brandt as superintendent and engineering inspirater. Zerah Colburn was mechanical engineer of this company for several years and designed several locomotives that made their mark on motive power development. The locomotives built by this company were generally known as Brandt engines, after the fashion that prevailed so long of calling the locomotives Baldwin, Norris, Hinkley, Wilmarth, Mason, Rogers, McQueen and so on. Those were the days when engines were assigned to certain engineers who ran them, repaired them, and petted

them. Many a romance was related of the wonderful work done by pet engines and the veracity of enginemen when dilating about favorite locomotives was on a level with the angler describing the fish caught.

Most of the locomotives built under Brandt's supervision were eight wheelers with outside cylinders and the steam chest set on an angle, the outside dipping towards the track. That was a plan introduced by Rogers to facilitate valve facing but used mostly by Brandt. The engines were well put together and held high popularity on all the roads where they were used.

About 1863, the company having become financially embarrassed, D. B. Grant, a New York banker, secured control of the property and changed the name to the Grant Locomotive Works. The new owner appointed Willard Fairbanks superintendent and John Nichols assistant. Fairbanks had been a master mechanic on the New Haven, Hartford & Springfield Railroad and gained quite a local reputation for two locomotives, the "Comet" and the "Planet," which he built for the railroad named.

The most celebrated thing done by this concern was the sending to the Paris Exposition of 1867 a most elaborately finished locomotive which was awarded the gold medal.

What brought to the works less notice, while more useful than show finish, was systematic effort to secure exact interchangeability of parts. This work was carried on for years and had much to do in promoting railroad sentiment in favor of exact duplication of the mechanism. The sentiment that led to this may be regarded as a good inheritance which the works received from John Brandt.

In 1883 the Grant Locomotive Works fell into the hands of people interested in city lots speculation and were moved to Chicago and installed in buildings on the edge of the prairie to the west of the city. Here their career as locomotive building works ended.

### Danforth, Cooke & Co. Locomotive Works.

The establishment which eventually developed into the Danforth, Cooke & Co. Locomotive Works was started about the year 1800 by John Clark, a native of Scotland, his specialty being the making of wool-carding machines. John Clark, the son of the founder, some years later expanded the business into

the making of power looms and other textile machinery. In 1830 Charles Danforth, a maker of spinning frames from Ramapo, joined the Clark concern, which prospered under his management. Wishing to add a locomotive building shop to the works, in 1852 he invited John Cooke to join him as a partner and to take charge of the locomotive building part. Mr. Cooke had been a foreman in the Rogers works and was considered a remarkably able locomotive builder. Like many others who became leaders in the metal trades, John Cooke was originally a pattern maker.

The new concern was called Danforth, Cooke & Co., other practical men from Rogers, Ketchum & Co. having come with Mr. Cooke, formed the "company" part.

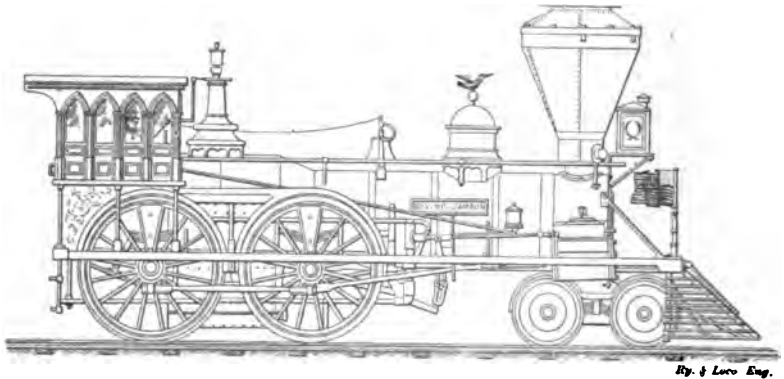

Fig. 114. Danforth, Cooke & Co., 1853

The company were noted from the start for the excellent engines turned out, a representative specimen of their early engines being shown in Fig. 114. This engine, built for the New Jersey Railroad & Transportation Company, was finished in 1853, and the company were so much pleased with the work done and with their prospects that they treated their employees to a supper in honor of the engine.

In 1854 Danforth, Cooke & Co. received a large order from the Delaware, Lackawanna & Western Railroad which brought them so much celebrity that their good name was firmly established. Some of the engines ordered were for the burning of anthracite, which was done successfully, a performance by no means common in those days.

With various changes the Cooke Locomotive & Machine Works have maintained their identity to the present day and were absorbed by the American Locomotive Company in 1901. They are still in active business building locomotives, rotary snow plows and other railroad machinery.

### Locomotives Built in Hoboken, N. J.

The first locomotives built in the State of New Jersey were the product of marine engineering shops owned by Colonel R. L. Stevens, president of the Camden & Amboy Railroad, some of whose work in that connection has been already mentioned. Shortly after the Camden & Amboy Railroad was opened, Colonel Stevens sent Isaac Dripps, his superintendent of machinery,



John Cooke

to his engineering works at Hoboken to take charge of the work of building locomotives for his railroad. The four wheel engine was working satisfactory and it was determined to use that pattern for the new ones. Three such engines were built in 1832 and four the year following, which ended the locomotive building achievement of the Stevens Works, except that the work on one of the Monsters was begun there.

The locomotives known as the Monsters deserve some notice since it was the first attempt to employ eight wheel con-

nected engines in the United States. The first engine of that kind was finished by Isaac Dripps in the Camden & Amboy Railroad shops at Bordentown, N. J., in 1836. This engine may be regarded as the first double truck locomotive, for the first four wheels were coupled together by side rods and the second pair were coupled in the same way, the two pairs of trucks being driven by a huge gear wheel set on the middle of a supplementary axle. This gear engaged with gears set upon the axles of the middle pair of wheels.

### Seth Boyden, Locomotive Builder.

Early in 1837, when Rogers was working on his first locomotive, a new candidate for fame and fortune through loco-



Cooke Locomotive, 1868

tive building went to work in New Jersey. This was Seth Boyden, a versatile genius who is credited with inventing malleable iron, enameled leather, Russia sheet iron, a machine for making nails, an automatic cutoff that acted upon the valve instead of upon the throttle and a great many other useful inventions. In 1836 Boyden was making stationary engines in Newark, N. J. The Morris & Essex Railroad being near completion at that time, he proceeded to build locomotives to operate the road.

### Boyden's Orange.

His first engine, the Orange, which weighed about 14,000 pounds, was finished early in 1837. It is illustrated in Fig 115

from what were original drawings. The cylinders were  $8\frac{1}{4} \times 26$  inches, making the stroke more than three times that of the diameter. That locomotive had no counterbalance weights in the driving wheels, and it may safely be assumed that the swing of the crank pin and its connections, 13 inches from the center of the axle, would provide an eloquent object lesson as to length of stroke and want of counterbalance. This engine had a peculiar valve motion actuated by a single return crank, operating through an elliptical disk which effected reversing in the way the early Baldwin engines were reversed with a hook that engaged the upper or lower pin of a rocker arm, an arrangement devised and used by Carmichael, a Scottish marine engine builder, many years before.



Seth Boyden

Boyden built another engine the following year to which he applied a cutoff motion designed for stationary engines. As far as can be made out from the drawing which appears in the chapter on valve motion, it is a single eccentric contrivance with the lead and lap advance taken from the crosshead, reversing being effected by a box link.

That ended Boyden's work of locomotive building for American railroads, but he built one in 1841 for the Cardenas Railroad of Cuba.

#### **Breeze, Kneeland & Co.**

Early in the 50s Breeze, Kneeland & Co. opened locomotive building works in Jersey City, N. J., and they went vigorously

to work building locomotives that were thoroughly up to date but in some respects too advanced for the train service of those days. The proper name of the establishment was the New York Locomotive Works. One of their engines built for the Hudson River Railroad in 1854 and illustrated on page 160 had driving wheels 78 inches diameter. Most of their engines were of that type but with smaller driving wheels. The panic of 1857 closed the career of Breeze, Kneeland & Co.

### Building Atlantic and Great Western Locomotives.

The works remained idle until 1865, when they were rented to a noted capitalist and speculator, James McHenry, who had undertaken to build the Atlantic & Great Western Railway, a six-foot gauge road that connected with the Erie at Salamanca and extended to Marion, Ohio, about 300 miles. Locomotives were wanted for this new road and Mr. McHenry conceived the

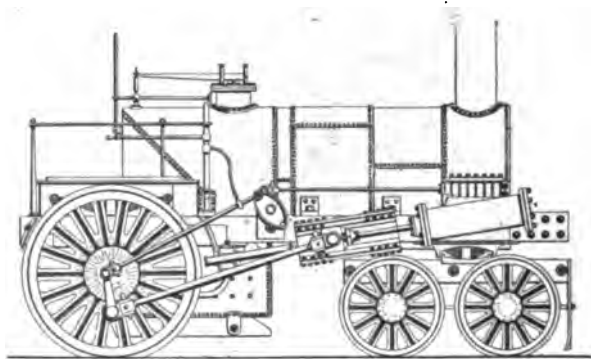

Fig. 115. "Orange," Built by Seth Boyden at Newark, 1837, for Morris & Essex Railroad

idea that it was better to build them under his own supervision than to purchase from the existing builders who were unusually busy with orders from the government for war rolling stock. The shops were organized by Wm. G. Hamilton, general manager, who appointed Thos. S. Davis superintendent. Among the foremen was C. A. Thompson, who afterwards became master mechanic of the Long Island Railroad and ended his railroad career as superintendent of motive power of the Central Railroad of New Jersey. Mr. Thompson had previously been a foreman in the Breeze & Kneeland shops. Digitized by Google



Several hundred locomotives were built for the Atlantic & Great Western, and then the works were closed in 1867. There had been nothing worthy of note done in the shops, merely the building of ordinary locomotives. Mr. Davis, the superintendent, had a patent piston valve which he applied to one engine. When used in train service the piston valve did not work satisfactorily, but he achieved some success with it on the Chicago, Milwaukee & St. Paul Railroad.

After the works were closed, most of the leading men obtained positions on railroads. Mr. Davis was appointed general master mechanic of the Chicago, Milwaukee & St. Paul Rail-



C. A. Thompson  
One of the Railroad Pioneers Still Alive

road. Mr. Thompson and Nathan Wright, another foreman, obtained positions as master mechanics of western railroads. All the others drifted to various industrial pursuits as always happens when manufacturing establishments close.

#### Expiring Gasp of Jersey City Shops.

In 1869 the Jersey City locomotive shops were again leased, this time to Nathaniel McKay, son of a famous ship builder of Boston, who expected to establish successful locomotive building works. He formed a company which was called the New

York Locomotive Work Company. The shops were organized and a few new tools put in, but somehow the railroad companies did not encourage the resuscitated concern, and after building a few locomotives the old Breeze & Kneeland shops were closed permanently.

### Trenton Locomotive Works.

For modern conditions of manufacture Trenton ought to be one of the best located towns in New Jersey. Its people made one rather ambitious attempt to establish locomotive building in the town, but after a vigorous birth the progeny languished for about five years and then gave up the ghost. The locomotive builders had the name of Van Cleve, McKean, Dripps & Co., but better known as the Trenton Locomotive Works.

About the first work done by that company was finishing the "Monster" which had been the conception of Stevens & Dripps and was partly built in the Camden & Amboy shops at Bordentown. The expectation of the Trenton builders was that powerful locomotives would be in demand by railroad companies hauling heavy freight, such as coal and other minerals. A demand of that kind was growing, but people did not take kindly to the Monster type, so the company worked into a fair business building ordinary eight wheel locomotives.

The works were started in 1853 and closed in 1858. The building of locomotives was abandoned, but four years later ordnance work was taken up and the company did considerable work for the government.

The leading practical man of the Trenton Locomotive Works was Isaac Dripps, the man who first held the title of Chief of Motive Power of the Pennsylvania Railroad. The Trenton Locomotive Works built several engines for the Belvidere & Delaware Railroad, and in that connection Mr. Dripps designed the wide tread wheel suitable for standard 4 feet 8½ or 4 feet 10 inch gauge of track. A decided novelty connected with the engines built for the Lehigh Valley Railroad was outside links driven from main crank pin by a return crank and eccentric with pin in it. That was a novelty but no improvement. It will be noticed that the engine illustrated in Fig. 116 was equipped with the Allan straight link.

In 1857 the Trenton Locomotive Works built for the Lehigh Valley Railroad the first iron freight car truck of the so-

called "diamond" form almost universally used under freight cars for many years. Among the celebrated mechanics connected with the Trenton Locomotive Works was J. I. Kinsey, who was afterwards for many years a master mechanic on the Lehigh Valley Railroad.



Fig. 116. Trenton Locomotive for Belvidere & Delaware Railroad, 1855,  
with Allan Link Motion

# The Erie Railroad

## CHAPTER XVII.

### **New York Backward in Pushing Railroad Enterprises.**

While the people of New England, Pennsylvania, Maryland and South Carolina were pushing forward railroad enterprises, the people of New York City continued to be very apathetic concerning railroad development. They were enjoying the Erie

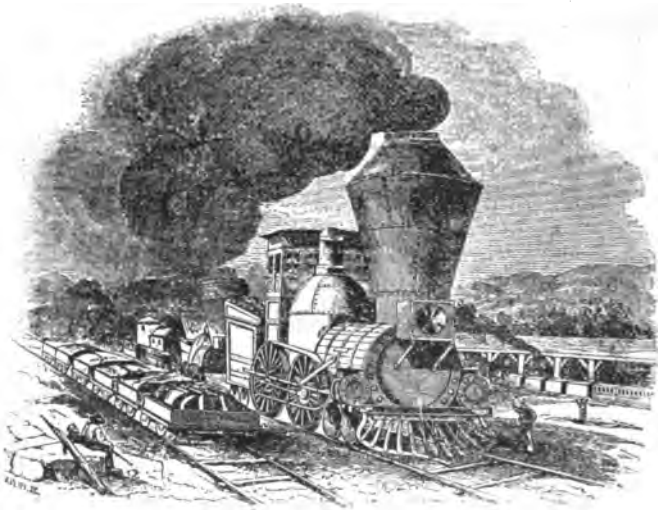

Erie Locomotive of 1846. From "The Story of Erie," by E. H. Mott  
Sketched at Susquehanna in 1852

Canal as an artery to draw business from the western territories and it took them a long time to learn that anything better was necessary.

### **To Promote Means of Intercommunication.**

Yet, the scheme of a great land thoroughfare from New York to the western borders of the State was advocated and discussed long before the Erie Canal was thought of. During

the Indian War of 1779, General Clinton had led an army through the Susquehanna, Chemung and Genesee valleys, and he conceived the idea of connecting the seaboard with the great lakes by a thoroughfare that should pass through the valleys mentioned which are in the counties bordering the State of Pennsylvania, and would form the beginning of a national avenue leading to the Pacific Ocean.

General Clinton had been sent in 1779 into the Susquehanna, Chemung and Genesee valleys to chastise the Indians living in these regions, who, under the instigation of British generals and Tory enemies of the Union, had committed terrible outrages upon the white settlers. General Clinton perceived that the proper way to keep savages in subjection was the opening of the country by good roads. That policy was successfully pursued about the same time by General Wade as a means of subduing the wild clans in the Scottish Highlands.

#### **An Appian Way Proposed.**

After the war was ended, General Clinton applied to Congress for an appropriation to construct a road which he called the "Appian Way" after a great Roman road between Rome and Capua, constructed by Appius Claudius 300 B. C. Congress would do nothing for the enterprise, but General Clinton never relinquished his efforts to have the nation undertake the great work, and on his death the idea of connecting the ocean and the lakes by a public thoroughfare was taken up by his son, known to history as Governor DeWitt Clinton.

#### **Short Lived Fame.**

In passing it is well to remark that in the popular memory DeWitt Clinton, one of the most influential governors of New York State, is known principally through a pioneer locomotive having been named after him. It is a grim satire upon the justice of history, that the most influential promoter of the Erie Canal should have this kind of reflection of his fame. The public memory is short. Ask ten average men who DeWitt Clinton was and all answer: "I never heard of him." Among the same number of railroad men two will answer it was the name of the first New York Central locomotive.

#### **Canal Preferred to a Highway.**

DeWitt Clinton, after advocating for several years the construction of the Appian Way, was by circumstances constrained

to divert his influence to advocating the construction of the Erie Canal, which was opened in 1825. In order to induce the legislators from the southern tier of counties of New York State to give their support to the canal scheme, Governor Clinton promised that those who had promoted the canal would in turn endeavor to obtain through the legislature the help needed to construct the Appian Way. This brought the required support to the canal interests; but instead of reciprocating the favors the canal ring not only refused to help the land transportation interests, but always threw every obstacle they could wield against every movement originated to provide the people with any other means of transportation outside of the Erie Canal. The successors of the first Erie Canal ring have never deviated from the infamous policy inaugurated by the first board. They have always regarded the public as their natural prey and they have never failed to fatten upon it.

### **Erie Railroad Proposed.**

While part of the people were vainly urging claims for assistance in the building of a great public highway to traverse New York State, a proposal was made that public funds should be devoted to the construction of a railway over the route proposed for the Appian Way. The agitation in favor of this enterprise brought forth after painful travail the Erie Railroad.

Years before the Erie Canal was commenced that wonderfully farseeing man, Col. John Stevens, of Hoboken, proposed the building of a railroad over the same route, and he presented plans which were entirely practicable as viewed from the standpoint of present experience. Most of the people regarded Col. Stevens' idea as visionary, but he had a small following which was ready to join in advocating railroad building.

### **Agitation in Favor of Erie Railroad.**

As might have been expected, the first agitation working for the construction of a railroad from the Atlantic coast to Lake Erie did not originate in New York City. The first meeting of people favorable to the enterprise was held at Monticello, N. Y., in July, 1831. That enterprising town, which is near the Catskill Mountains, was never touched by the Erie Railroad. This movement was followed by meetings in Jamestown, in Angelica, in Owego, in Binghamton, and in other inland towns. There were various conventions attended by influential men who ad-

vocated the project and helped to influence public opinion in its favor.

At that time the proposal to build a railroad four hundred miles long was advocating a stupendous project, the magnitude and difficulties of which were little appreciated. The blind public, swayed by the eloquence of enthusiasm, shouted, "Let us have the great railroad built—by the State." The real difficulties of the enterprise began to be encountered when it became apparent that a survey of the whole route must be made. Who was to pay the expense of such a survey?

### Political Consideration Stopped Survey.

The United States Government was applied to and agreed to have the work done by its own engineers, but just as these

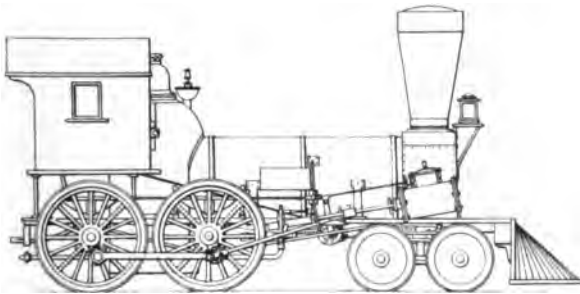

Fig. 117. Erie's Orange

men were about to enter the field an order was received from President Jackson withdrawing the engineer corps on the ground "that the building of this railroad would make a thoroughfare that would be a rival to the Erie Canal, the effect of whose political patronage would be likely to be neutralized by the patronage of the railroad, the latter not being under State control, thus making it impossible to manage the politics of the State so well as they are managed now." The Erie Canal people had effected the first knock down in this fight.

### New York and Erie Railroad Company Organized.

After immense waste of words and efforts, the New York & Erie Railroad was organized in 1833, with Eleazar Lord, a New York capitalist, as president. Multifarious schemes were resorted to for the raising of funds, the most striking thing about

them all being the meager money help that the individuals interested were willing to provide. By the sale of stock a small capital was collected, a remarkably defective survey of the line was made, and actual operation in building the railroad was begun in 1835.

The scheme as projected and promulgated to the public was the construction of a railroad from New York City to Lake Erie. Owing to an influential director of the company having been owner of some swamp land on the west bank of the Hudson River, about 25 miles from New York, the eastern terminus was made there at Piermont.

### Curiosities of Railroad Construction.

When the company were ready to begin grading, some influential official conceived the brilliant idea of commencing the work in the Delaware Valley, 175 miles west of New York, in a wild, rocky wilderness, and that actually was done. All the supplies needed had to be conveyed long distances at great expense.

When grading of the Erie was begun in 1835, the engineering world of the United States had acquired considerable knowledge about the kind of roadbed and track best adapted to the carrying of locomotives and cars, yet those in charge of the Erie construction appeared to have learned very little from the experience of others. On the Susquehanna & Chemung sections, 100 miles of piles were driven through dry ground to take the place of a graded roadbed, at a cost estimated at nearly one million of dollars, and not a single foot of that expensive trestle was ever used. Probably the construction engineers were not to blame, as the plan was proposed by a celebrated military engineer of the time, who happened to be a friend of the Erie president. Many other very expensive things were done which proved how slowly information concerning railroad building was circulated among the people entrusted with the expenditure of the company's money.

### Erie Railroad Deserved State Aid.

If ever a railroad deserved State aid that was the Erie, for its services were badly needed in a great stretch of country that had helped to pay for the Erie Canal but had reaped no benefit from the taxes paid to build that waterway. But the Erie Canal interests were keenly watchful to oppose anything likely to



favor a railroad thoroughfare in the State. Yet, like most other combinations kept in life through the profits of public plunder, the Erie Canal ring were short-sighted and their leaders failed to recognize what was destined to be their most dangerous rival. They pursued the Erie Railroad project with persistent malevolence, but they failed to perceive that the short links of railroad built close to the banks of their own big ditch might be joined together in a continuous chain, extending from the ocean to the lakes. The Mohawk & Hudson, the Utica & Schenectady, the Syracuse & Utica and other small lines reaching towards Buffalo were permitted to proceed unmolested to eventually form a through line which dried the heart of the Erie Canal and left it merely a streak of stagnant water fit only as a basis for putting more burdens upon the taxpayers of the State.

### Establishing the Gauge.

The history of the Erie Railroad is largely a record of financial makeshifts and disasters that began long before a rail was laid. Eight years after the company was incorporated part of the line near the Piermont end was ready for track laying. An important question then to be considered was the gauge of track. Ezekiah C. Seymour, chief engineer and a personal friend of President Lord, insisted that the gauge should be 6 feet and he had his own way. It was an unfortunate decision as events proved, but his engineering ideas were sound. Efforts were made by influential interests to have the gauge changed to 4 feet 8½ inches when less than 100 miles of track had been laid, but they failed, and the work of changing had to be done many years later.

### Curiosities of Track Gauges.

One of the most curious things met with in railroad history is the influences by which certain track gauges were established. The settling of a gauge likely to prove most convenient for the business to be done with due consideration as to cost, is an engineering problem which ought to have received careful study and profound calculation. Instead of that the gauge has been generally decided by some trifling whim or accident.

In 1840 there were 33 separate railways in the British Isles with 1,552 miles of track and they had five different gauges, ranging from 4 feet 8½ inches to 7 feet—the narrowest gauge having

more mileage than all the others. That was George Stephenson's gauge, and it was established in a curious way. The gateways of the first coal railway, operated by Stephenson's engines, had openings just sufficiently wide to permit wheels to pass extending 5 feet. At that time the flange of the wheel was outside the rail. When the Stockton & Darlington Railway was built Stephenson put the flanges inside. The width of the rail head was about 2 inches, so the inside gauge was 4 feet 8 inches. When the Liverpool & Manchester Railway was under construction, the engineers concluded that it was better to give the wheels plenty of side play to make fast running easy, so they widened the gauge half an inch, making it 4 feet 8½ inches.

The success of the Liverpool & Manchester Railway and of the locomotive "Rocket" made George Stephenson a great man, whose example was worthy of imitation, so his track gauge of 4 feet 8½ inches was adopted by most of the British railway companies. His son Robert had locomotive building works which supplied many of our early railroads with engines, and the track gauge was frequently established to fit the wheels of the locomotives imported.

### Early American Track Gauges.

The South Carolina Railroad track was laid to 5 feet gauge, which became that of southern railroads and continued so up to the Civil War. Towards the Ohio River some of the railroads had a gauge of 5 feet 6 inches. There was greater confusion in the North. The railroads that began by using imported engines had mostly 4 feet 8½ inches gauge; but there were to be found gauges of 4 feet 9 inches, rising by inches to 5 feet. Canadian railways had 5 feet 6 inch gauge and, as mentioned, the Erie was 6 feet.

The wide gauge was adopted by the Erie because the chief engineer believed that the grades would be so heavy in crossing the mountains that enormously large engines would be needed to haul the trains and that a narrowed gauge would not provide room for the size of boiler necessary. The president favored the wide gauge because he was opposed to the Erie having facilities of interchange with other railroads, that might be the means of diverting business from New York City.

When the days of railroad consolidation came about the capitalists decided to adopt the narrow gauge, which was 4 feet 8½ inches, now known as the standard, that then having much

greater mileage than any other gauge. That decision was a mistake, for the gauge is too narrow for admitting the kind of boiler a large locomotive ought to be provided with. As the locomotives used on the standard gauge are increased to their full capacity, which has already been reached in some instances, the railroad world will realize that a 6 foot gauge would be better than the existing standard.

### Operating of Erie Begins.

The first section of the Erie opened for business, which was in 1841, was that between Piermont and Goshen, but trains had been run for a few months previously to Ramapo. The company had purchased three engines from Norris, the Eleazar Lord, the Piermont and the Rockland. They were eight-wheel engines with Bury boilers and no cabs. The cylinders were 13x20 inches,

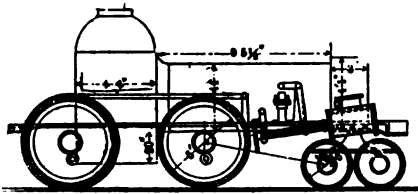

Fig. 118. Rogers' Sullivan First Engine for Erie

the driving wheels 4 feet 6 inches in diameter and the Eleazar Lord weighed about 30,000 pounds, while the others weighed 32,000 pounds, with similar dimensions of parts. All arrangements connected with the purchase of the first locomotives were made by George H. Hoffman, engineer of construction.

The first intention of the company had been to purchase Rogers engines, the builders being at Paterson, N. J., near the Erie line, and Rogers, Ketchum & Grosvenor had been invited to submit bids; but they wanted \$9,000 per engine and would accept no New York and Erie Railroad stock as par payment. William Norris consented to make engines for \$8,000 each and take \$3,000 in the railroad company's stock, so he received the first order. He supplied two more engines, the Orange (page 259) and the Ramapo, which were afterwards known as Nos. 4 and 5, and were a little heavier than those previously built.

### John Brandt.

About the time track laying was begun, the Erie Company engaged John Brandt as master mechanic. He had been for sev-

eral years on the Philadelphia & Columbia Railroad, and had gone from there to be master mechanic of the Georgia Railroad, which he left to join the Erie. He was an excellent mechanic and good locomotive designer, besides being an accomplished shop manager. He had organized the Philadelphia & Columbia shops at Parkesburg, Pa., and put a decided mark on improving the pioneer locomotives. He was the first man to work on the introduction of uniform screw threads for railroad machinery.

John Brandt designed a ten-wheel engine about 1843, having come to the conclusion that such an engine was necessary for the Erie grades. He tried to obtain permission to build it at Piermont, but the officials would not consent. They directed him to send the drawings to Baldwin's, which was done, but Mr. Baldwin, who was then opposed to multi-coupled engines, would not bid on building it. Norris was next tried, and he was willing to build the engine and named a price, but the engineering department of the Erie declared it to be too high and, as they were opposed to heavy engines at that time, nothing was done about it. Brandt afterward sent the drawings to James Millholland, who built an engine according to the drawings.

Brandt left the Erie and became superintendent of the New Jersey Locomotive and Machine Works, Paterson, N. J., which prospered under his management. He remained in the business several years, building locomotives, which held a high reputation. He was of Pennsylvania German stock, with strong home affinities, and never settled away from his native town, Lancaster, Pa. After being in Paterson a few years he tired of the place, and returned to Lancaster, where he built works for the construction of locomotives, but did not live to see them in operation.

### **Adopts Ten-Wheel Engines.**

The opposition and shortsightedness to the introduction of heavy locomotives could not last long on a railroad that had to climb over mountains. About 1850 the road began using ten-wheelers made by Rogers. They had inside cylinders and half cranks. Connection was made with the middle axle and the guides for the crossheads were set above the front axle. The engines had outside bearings and equalizing levers between the springs; they had cranks on the outside of the frames for the side rods and independent cutoff valves were provided.

This was the first move of the Erie towards motive power adapted for working its long steep grades.

### Variety of Locomotives That Belonged to the Erie.

By the time the Erie Railroad was opened from the Hudson River to Lake Erie the company appears to have had locomotives built by nearly every locomotive builder in the country. The idea of keeping railroad machinery as nearly uniform as possible in details had not then become popular, for according to a report made in 1870, the company had eighty-five different patterns of locomotives. The builders were numerous and, of course, they were all striving to surpass each other in the building of engines that would secure popularity and thereby increase the business of the makers. There was long a belief prevalent among railroad men that certain makes of locomotives were better per se than other makes, and that they could do more work without exact regard to the dimensions. Latter day engineering has demonstrated that one make of engine must exert as much tractive

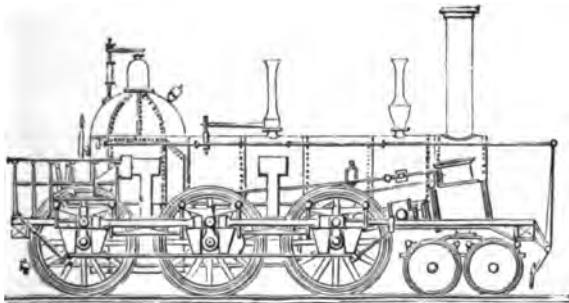

Fig. 119. Rogers' First Ten-Wheeler for Erie Railroad

power as another when the dimensions and steam pressure are equal; but very different opinions held sway among pioneer railroad men, and they have not entirely disappeared to-day. There were differences of details that made and held the reputation of certain makes of locomotives; although they were no better than others less favored. Difference in valve gear would make one engine smarter than another in starting, while a second would be noted for persistent pulling on long grades. The size of valves, arrangements of steam and exhaust pipes and dimensions or position of draft appliances would exert a good or bad influence on the engine that would establish its reputation. Train men and others became as strong adherents of certain makes of engines and as bigoted concerning their merits as religious people become of certain tenets of faith, and were prepared to quarrel about them as blindly and as zealously.

### Erie Motive Power.

In 1853 an article appeared in the American Railway Journal describing the Erie motive power of that day, which gives such a good idea of the gradual growth of the locomotive, that I think it will make interesting reading to people connected with railroads. The article has features which make me believe that Zerah Colburn was the writer. Particulars of the first Norris engines have been given. The descriptive article referred to says:

Engines 4 and 5, by Norris, have  $10\frac{3}{4}$  inch cylinders, 18 inch stroke, four drivers 4 feet 7 inch diameter and 4 feet trucks; 343 square feet tube surface, 33 of firebox surface and  $7\frac{1}{2}$  feet of grate. Weight, 30,700 pounds, of which 21,100 pounds are on the drivers. Steam used at one revolution, 3,782 cubic feet.

No. 4, shown in Fig. 117, was called the Orange and had a romantic history noted further on.

No. 6, by Rogers, Ketcham & Grosvenor, weighs 40,625 pounds, on drivers 24,250 pounds. No. 7, by same builders, [Fig. 118] weighs 48,200 pounds, of which 31,300 are on drivers; cylinders outside,  $15\frac{1}{2} \times 22$  inches; 5 feet drivers and truck.

No. 9, Baldwin, has outside connected cylinders 15 inch diameter, stroke 18 inches. Six drivers 46 inch diameter, no truck; 860 square feet tube surface to  $42\frac{1}{2}$  firebox; 8 square feet of grate and weight on all drivers 44,200.

No. 10, by Norris, outside cylinders  $12\frac{3}{8}$  inch by 26 inch; 4 drivers 5 feet diameter on truck; heating surface, 708 square feet in tubes, 54 in firebox and 10 square feet grate area; weight 43,920, of which 26,880 are on drivers.

Nos. 11, 13, and 17, by Swinburne, Smith & Co., have the half crank, cylinders 17 inch by 20 inch stroke; have four 4.6 feet drivers and truck;  $943\frac{1}{2}$  square feet tube,  $68\frac{1}{2}$  square feet firebox, and  $12\frac{7}{8}$  square feet of grate surface.

Nos. 14, 15, 16, 36 to 39 inclusive, and 46 and 47 by the same builders, same as above, only 5 feet drivers,  $59\frac{1}{2}$  square feet of firebox surface and  $12\frac{1}{8}$  square feet of grate; weight 59,900 pounds, of which 27,900 pounds are on drivers. Steam used at one revolution, 10,508 cubic feet.

No. 12, by Rogers, Ketcham & Grosvenor [Fig. 119] half crank, 17 inch cylinders, 20 inch stroke, six 5 feet drivers and truck, 1,030 square feet tube, 67 square feet fire box and 15 square feet of grate surface; weight, 58,000 pounds, of which 42,300 pounds are on drivers. Steam used at one revolution, 10,508 cubic feet.

Nos. 18, 19, 28, 29 and 32, by Rogers, Ketcham & Grosvenor: half crank, 17 inch cylinder, 20 inch stroke; four 6 feet drivers and truck;  $922\frac{1}{2}$  square feet tube,  $67\frac{1}{2}$  square feet fire box and 13 square feet of grate surface. Weight, 56,500 pounds, of which 35,750 are on drivers. Consumption of steam, same as No. 12.

Nos. 30 and 31, by same builders, have 5 feet drivers and  $61\frac{1}{2}$  square feet of furnace surface. Weight, 54,500 pounds, of which 33,500 pounds are on drivers.

Nos. 20, 21, 23 and 27, by M. W. Baldwin, same as 18 and 19, except 938 square feet tube,  $65\frac{3}{4}$  square feet fire box and  $12\frac{7}{8}$  square feet grate. Weight, 56,500 pounds, of which 34,800 are on drivers. Nos. 22, 24, 25 and 26, by same builder, same as 20 except 5 feet wheel and 60 square feet of firebox surface. Weight, 54,500 pounds, of which 32,600 are on drivers.

Nos. 33, 34 and 35, first-class freight engines, by Rogers, Ketcham & Grosvenor. These have half cranks, 18 inch cylinders, 20 inch stroke; six 5 feet drivers and truck. Boilers, 48 inch diameter, containing 198 tubes  $1\frac{3}{4}$  inch diameters and 13 feet long: 1,179 square feet of tube, 72 square feet of fire box and  $14\frac{3}{4}$  square feet of grate surface. Weight, 65,000 pounds, of which 49,000 pounds are on drivers; the amount of steam expended at one revolution, 11.78 cubic feet.

Nos. 40 to 45, inclusive, by Rogers, Ketcham & Grosvenor, have nearly the same dimensions and weight as Nos. 30 and 31, by the same builders. The general dimensions are identical. The weight may be given as 28 tons, of which 16 tons are on the drivers.

No. 48, by Swinburne, Smith & Co., has half crank, 16x20 cylinder, four 5 feet drivers and truck. Boiler has  $784\frac{1}{2}$  square feet tube,  $60\frac{1}{4}$  fire box and 13 of grate surface. Weight, 50,700 pounds, of which 32,100 are on the drivers. Steam used at one revolution, 9.308 cubic feet.

Nos. 49, 50 and 51, and Nos. 67, 68 and 69, by Swinburne, Smith & Co., have half cranks, 17 inch cylinders, 20 inch stroke, six 5 feet drivers and truck. Heating surface  $1,025\frac{1}{4}$  square feet tube,  $61\frac{1}{2}$  square feet fire box and  $13\frac{7}{8}$  square feet grate surface. Weight averages 62,500, of which 45,500 are on drivers. Steam used at one revolution, 10.508 cubic feet.

Nos. 52, 53 and 54, built by the Western Locomotive Works, have inside connected cylinders 15 inches in diameter, 20 inch stroke; four 5 feet drivers and truck; 711 square feet tube surface,  $59\frac{1}{2}$  square feet fire box and 10 square feet grate surface.

Weight, 47,920 pounds, of which 30,050 are on drivers. Steam used at one revolution, 8.181 cubic feet.

Nos. 57 and 58 [Fig. 120] are first-class engines, by M. W. Baldwin; they are used as pushers on 68 feet grades. They have  $18\frac{1}{4}$  inch cylinders, 23 inch stroke, 8 connected drivers and 4 feet diameter and contain 147 tubes of 2 inch diameter and 14 feet long; 1,077 square feet of tubes,  $67\frac{1}{2}$  square feet of fire box and 14 of grate surface, and 4 forward drivers, which combined in truck, although it would seem that the coupling rods would prevent any sensible vibration. The whole weight of these engines is 73,700 pounds, of which 45,700 pounds are on the four forward drivers alone, giving 11,425 pounds, or nearly  $5\frac{3}{4}$  tons, on a single wheel. Steam used at one revolution, 13.927 cubic feet.

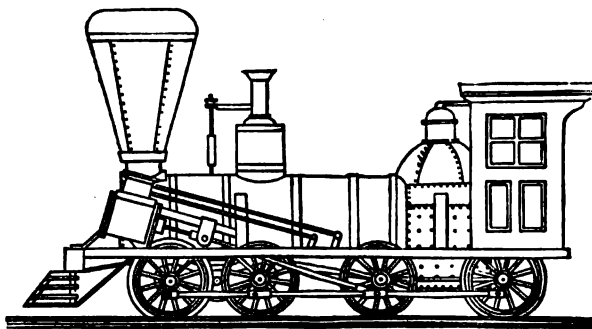

Fig. 120. Baldwin Pusher on Erie

Nos. 61, 62 and 63, by Taunton Locomotive Manufacturing Co., these are inside connections, with 17x20 inch cylinders, four 5 feet drivers and truck.

Nos. 64 and 65 are extreme outside connections built by Rogers, Ketcham & Grosvenor. They have 17x30 inch cylinders, four 5 feet drivers and a truck; 795 square feet of tube surface,  $57\frac{3}{8}$  fire box,  $13\frac{1}{4}$  grate. Weight, 55,600 pounds, of which 35,600 pounds are on the drivers. Steam at one revolution, 10.508 cubic feet.

No. 66, inside connected, by Rogers, Ketcham & Grosvenor, 17x20 inch cylinders, four 6 feet drivers and truck,  $872\frac{3}{4}$  square feet tube surface,  $75\frac{1}{2}$  fire box, 14 square feet of grate surface. Weight,  $28\frac{1}{4}$  tons.

Nos. 70 and 71, inside connections, by Swinburne, Smith & Co. Cylinders 17x20 inches, four 6 feet drivers,  $948\frac{1}{2}$  square feet tube surface,  $71\frac{1}{4}$  fire box,  $13\frac{1}{2}$  square feet grate. Weight, 53,000, of



which 33,900 pounds are on the drivers. Steam used at one revolution, 10,508 cubic feet.

Nos. 72 to 83, inclusive, inside connections, freight engines, by Swinburne, Smith & Co. Cylinders 17x20 inches, six drivers, four wheel truck, boilers 46 inches diameter, containing 157 2 inch tubes, 13 feet long; heating surface, 1,068 $\frac{3}{4}$  square feet in tubes, 69 $\frac{1}{4}$  inch fire box; 13 $\frac{1}{2}$  square feet of grate area.

Nos. 84 and 85, outside connected, are Norris eight-wheel connected engines. Cylinders 14x32 inches, drivers 7 feet diameter, 708 $\frac{1}{2}$  square feet tube surface, 54 $\frac{1}{2}$  fire box, 11 $\frac{1}{2}$  square feet grate area. Weight, 57,450 pounds, of which 38,950 pounds are on drivers. Steam used at one revolution, 11,403 cubic feet.

No. 86, half crank engine, built by Rogers, Ketcham & Grosvenor. Cylinder 17x20, 6-foot drivers and truck; 923 $\frac{1}{2}$  square feet tube surface, 67 $\frac{1}{2}$  fire box, 13 $\frac{1}{2}$  grate area. Weight, 65,175 pounds, of which 47,000 are on drivers. Steam used at one revolution, 10,508 cubic feet.

Nos. 87 and 112, inside connected, Boston Locomotive Works (Hinkley). Cylinders 15x20 inches, one pair of drivers 5 $\frac{1}{2}$  feet diameter, one pair of trailing wheels and four wheel truck. Heating surface in tubes 616 square feet, fire box 66 square feet, 11 $\frac{3}{8}$  grate area. Steam used at one revolution, 8,181 cubic feet.

Nos. 88 and 89, outside connected, by Ross Winans. Cylinders 19x22 inches, eight wheel connected; 918 $\frac{1}{4}$  square feet tube surface, 85 $\frac{1}{2}$  fire box and 20 $\frac{1}{4}$  grate surface. Weight, 56,000 pounds. Steam used at one revolution, 14,439 cubic feet.

Nos. 90 to 99, inclusive, inside connected, by Boston Locomotive Works. Cylinders 16x20, four 5 $\frac{1}{2}$ -foot drivers and truck. Heating surface of tubes 719 $\frac{3}{8}$  square feet, of fire box 62 $\frac{3}{8}$  square feet, of grate surface 10 square feet. Weight, 49,510 pounds, of which 30,840 pounds are on drivers. Steam used at one revolution, 9,308 cubic feet.

Nos. 100 to 105, inclusive, inside connected, by Rogers, Ketcham & Grosvenor. Cylinder 17x20 inches, four 6-foot drivers and four wheel truck. Heating surface of tubes 772 $\frac{1}{4}$  square feet, 80 $\frac{3}{8}$  square feet fire box, 15 $\frac{1}{2}$  grate surface. Weight, average 57,500 pounds, of which 37,400 pounds are on drivers. Steam used at one revolution, 10,508 cubic feet.

Nos. 113 and 114, Taunton engines, inside connected. Cylinders 17x20 inches, four driving wheels 5 feet in diameter and four wheel truck. Heating surface of tubes 939 square feet, 90 square feet in fire box, 16 $\frac{1}{8}$  grate area.

Nos. 115 and 118, inclusive, are by Taunton Locomotive Company. Cylinders 18x20 inches, four driving wheels 5 feet in diameter and four wheel truck. Heating surface in tubes 857¼ square feet, 90 square feet in fire box, 16⅞ square feet grate area. Steam used at one revolution, 11.781 cubic feet.

Nos. 119 to 124, inclusive, outside connected, by Boston Locomotive Works. Cylinders 16x26 inches, four drivers 5 feet diameter and four wheel truck. Heating surface of tubes 792 square feet, 83½ square feet in fire box and 15¾ grate area. Weight, 52,675 pounds, of which 31,000 pounds are on drivers. Steam used at one revolution, 12.101 cubic feet.

Nos. 125 and 126, by Amoskeag Manufacturing Company, inside connected. Cylinders 18x20 inches, six driving wheels 4½ feet diameter, no truck. Heating surface of tubes 893½ square feet, 74¾ fire box, 15 grate area.

Nos. 127 and 132, inclusive, Boston Locomotive Works. Cylinders 17x20, four drivers 5½ feet diameter, four wheel truck. Weight, 54,400 pounds, of which 34,950 are on drivers. Steam used at one revolution, 10.508 cubic feet.

Nos. 133 to 135, outside connected, by New Jersey Locomotive & Machine Company. Cylinders 16x20 inches, four 5-foot drivers and truck. Heating surface of tubes 670¼ square feet, fire box 54¼, grate area 12½. Steam used at one revolution, 9.308 cubic feet.

Nos. 136, 137, 138 and 141 same as No. 72, by Swinburne, Smith & Company.

Nos. 139 and 140, about the same as above, except 1,072½ square feet tube surface, 82½ fire box and 16¼ grate area.

Nos. 142 and 143, inside connected, by Essex Company. Cylinders 17x20 inches, four driving wheels 4½ feet in diameter and four wheel truck. Boiler 49 inches in diameter, containing 190 1⅞-inch tubes, 11 feet long, 1,025⅞ square feet tubes, 76⅞ fire box and 16 feet grate surface. Weight, 58,250 pounds, of which 36,450 pounds are on drivers. Steam used at one revolution, 10,508 cubic feet.

The article goes on to say that the Erie Railroad Company has contracted for the construction of 28 heavy engines having cylinders 18x20 inch stroke. A few particulars are given concerning the motive power of other leading railroads showing the tendency toward heavier engines than what had previously been used. A comparison is made with the motive power of the Baltimore & Ohio and with the Philadelphia & Reading, and a state-

ment is made that the motive power of the Erie is considerably heavier than any of the others, even when the others have very heavy grades to operate.

The first Hinkley locomotive was brought to the road by Horatio G. Brooks, who soon established a reputation for himself and for the engine by taking his trains through on time, a decided departure from the prevailing practice. Mr. Brooks, after a few years experience as engineer on the Erie, was appointed master mechanic of the Ohio & Mississippi. Two years later he was

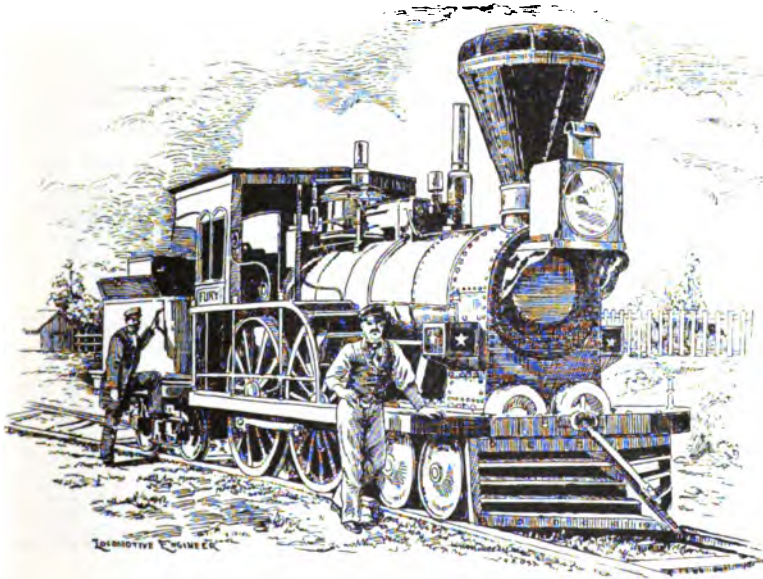

A Seth Wilmarth Shanghai

Built for Boston and Worcester in 1849. Were Called Shanghais on Account of Their Height. A Group of These Engines Were Sold to the Erie, and Building Them Ruined Seth Wilmarth. They Were Great Favorites with Train Men and Were Famous for Wading Through Deep Snow

called back to the Erie as master mechanic, and later superintendent of the Western division.

### The Erie Mascot.

In olden times nearly every well conditioned railroad had some pet locomotive that was the object of marvellous tales by train men. The mascot of the Erie was the engine Orange (on page 259) of William Norris build, and the fourth that came to

the road. This engine was the hero in a famous race from Albany to Piermont with Governor Seward's message to the Legislature in 1842, giving the New York Sun a "scoop" over the Herald that was long remembered.

The Orange was there first at a variety of railroad extensions, was ferried over rivers on rafts and was carried by canal boat and river steamer through many strange regions, was seized for debt and surreptitiously carried out of the jurisdiction of New York State. The engine was sold to the Hornellsville & Attica Railroad, which gave it the opportunity of sounding the first whistle heard in the Genesee Valley. More than ten years later it became the property of the Buffalo, Bradford & Pittsburg Railroad, doing good pioneer work there before petroleum began to taint the air of that region. The engine was reported to be in robust condition when last seen by the older inhabitants of the road, but finally mysteriously disappeared and caused as many romantic stories as the man with the iron mask.

### Through the Wilderness.

The Erie Railroad, with its far reaching mileage, involved problems of railroad operating that were entirely new and had to be worked out by the men in charge. The road was built through a wilderness of forests and wild lands. One of the men who went to Dunkirk for the ceremonial opening of the road wrote:

"Now comes a long tour through vast lumber regions, showing no evidence of cultivation except the noble road and now and then a secluded hut. We fly rapidly by places called Almond, Baker's Bridge, Andover, Genesee, Scio, Phillipsburg, Belvidere, Friendship, Cuba, Olean, Dayton, Perrysburg and Forestville. Most of these places are in the midst of the forest, with few or no houses visible, and wonder is often expressed as to where the assembled crowds come from, but they are there, and thriving settlements will soon begin to show what they are doing."

### Preferring Difficult Locations.

People familiar with the country through which the Erie passes are frequently surprised at the easy natural routes left out for locations obstructed by natural obstacles to railroad construction. The influences that led to the harder way being taken were at work on nearly all pioneer railroad enterprises. An extract from Mott's "Story of the Erie" explains how one difficult route was

preferred and probably other wandering lines originated from similar causes.

### Why the Railroad Went to Middletown.

The Western terminus of the New York & Erie Railroad was at Goshen not quite two years, but if the company had adopted what was known as the "Slate Hill route" from that place, Goshen would have continued to be the end of the road at least six years, and the distance between the Hudson and the Delaware would have been shortened ten miles, and the company would have saved more than \$325,000; but Middletown and Otisville would



Hackensack

Built by Rogers in 1860, for N. Y. & Hackensack Broad Gauge, Now Part of Erie

have been left off the line. The Slate Hill route extended from Goshen, in the southwesterly course, through the towns of Wawayanda, Minisink and Greenville, and along the eastern base of the Shawangunk Mountains. It was run by the engineers in one of the surveys supplemental to the original survey of 1834. As has been stated, the Shawangunk Range was one of the great obstacles to the thoroughfare for the railroad that had been found between the Hudson and the Delaware, and no feasible pass was discovered through the range except along its western face, beginning a mile beyond Otisville. This route required miles of deep rock cutting and earth excavation before a bed could be made for the railroad. The Slate Hill route would have carried

the road around and away from all those great difficulties, but there were several reasons why the company did not adopt it. One of these reasons was that the prospect of financial aid, which was greatly needed, was more promising at Middletown than it was along the Slate Hill way. The great obstacle to the south-western route to the Delaware Valley was, however, that to escape the Shawangunk Mountains difficulties of construction the railroad would have to be carried over the State line into New Jersey, and pass for a mile or more through that State to the valley at Carpenter's Point. The company's charter especially provided that the railroad must be confined to New York State territory. To take advantage of the Slate Hill route, the company would have been obliged to secure a change in its charter by consent of the Legislature, and the company was an anxious applicant just at that time for legislation of far greater importance to its future than was the privilege of building its road through a corner of New Jersey. So the present course from Goshen west, with its capricious windings and turnings, and big cuts and heavy grades, was the only one that could be chosen; and it was the only practical one, at any rate.

### **When Locomotives Had No Cab.**

The Erie Railroad officials were as enterprising as any of their contemporaries, but there were practices long in vogue that appear strange to the modern railroader. Although engines were running on the road as early as 1841, it was not till 1847 that the first cab was introduced for sheltering enginemmen.

The first engine to carry a cab was the Sussex, run by Joe Meginnes, a favorite engineer. Joe had made a trip over the New Jersey Railroad where he saw cabs in use. The sight made him dissatisfied with looking upon the bare boiler head, so he went to the superintendent and said that he must have a cab or he would quit the road. The cab was put on without loss of time.

### **The Coming of the Bell Rope.**

When train operating first began the engineer was captain of the train. Captain Ayres, an old soldier, who was one of the first conductors, changed the control of the train. As there was no bell rope to communicate between train and engine, Captain Ayres rigged one up. At the engine end of the rope he attached a piece of cord wood. He told the engineer, a German named

Hamel, that when he wanted to signal him he would pull the rope which would jerk the cord wood and attract attention. This did not suit Hamel, so he cut the cord and used the wood for fuel. It was time to settle the matter, so Ayres challenged the engineer to fight it out. The result of the encounter was that the bell rope returned to duty and became a fixture on all passenger trains.

### Prejudice Favored Wood Burning.

Wood was for years the universal fuel and for some reason the officials were slow to adopt the use of coal. As late as 1858 an experiment was made using Cumberland coal instead of wood. The engineers did not take kindly to the dirty fuel, and as the engineers of the Erie were a particularly important class their influence put an end to coal burning for that time, although a report



Rogers Engine, Called H. G. Brooks, Built for Erie in 1866, named for Superintendent of Machinery of the Road, who Afterwards Originated the Brooks Locomotive Works

of the experiment indicated that coal was forty-eight per cent. cheaper than wood that was becoming scarce.

This put off the evil day of coal burning for three years, but in 1861, three engines were fitted for coal burning and that began the change from wood, but it was not completed until 1872.

### Strikes.

The Erie Railroad has been noted for several very expensive strikes of the engineers and firemen. In 1854 the directors proposed putting in force a new set of rules for the guidance of the employees. General Superintendent Minot refused to attempt

enforcing the rules and resigned. His place was taken by D. C. McCallum who had framed the rules which were considered very strict in those days, but were afterwards accepted without protest by the trainmen of nearly all railroads. When attempts were made to enforce the new rules the engine-men protested vigorously against two of them and went out on strike. The two obnoxious rules were withdrawn after train running had been suspended for ten days.

Two years later another strike occurred among the engineers who were exasperated by what they considered tyrannical practices



Horatio G. Brooks, First Superintendent of Machinery of the Erie.  
Established Brooks' Locomotive Works

of Superintendent McCallum. This strike lasted about six months, cost the Erie Railroad company upwards of \$500,000, and had a most depressing effect on the securities of the company. Most of the trouble that brought about these strikes arose from engineers running off the track through switches being wrong. H. G. Brooks, who afterwards established the locomotive building works at Dunkirk, was one of the leaders of the 1856 strike and left the company's service.

That strike was managed by the directors who discharged the whole of a grievance committee that visited them when the strike began.



In 1857 President Moran ordered a ten per cent. reduction of wages and it caused a strike among freight handlers, who were receiving only one dollar a day. They were joined by the brakemen running out of Piermont and great trouble ensued. That strike was reported to have cost the company half a million dollars.

### Diversity of Motive Power.

The great variety in the types and makes of locomotives which the Erie gradually acquired and already mentioned became exceedingly expensive for repairs and maintenance. For a long time the mechanical department of the Erie was managed by division superintendents and the civil engineers, influences that have always had pernicious effects upon the selection of machinery. We have seen that when John Brandt, one of the best locomotive designers of his day, wanted to introduce ten-wheel engines his sensible proposal was frustrated by the engineering department.

An unfortunate condition of affairs which lasted for a long time was the division superintendents and master mechanics being permitted to decide the kind of motive power they wanted and the makers of the same. This accounted for the company having 85 different patterns of locomotives in 1870.

The interests of the company suffered greatly at times through the superintendents with no mechanical training insisting on certain ideas of their own being incorporated on the motive power. Charles Minot, one of the most efficient superintendents the company had, exercised very pernicious influence on the motive power in that way. He entertained a very tender regard for the rails, and to save them from unnecessary wear insisted that every part of the locomotive should be made as light as possible. He held that  $\frac{1}{4}$ -inch plate was thick enough for boilers and had that requirement put into the specification of new engines. Many serious boiler accidents resulted from this policy.

### H. G. Brooks.

In 1865 Horatio G. Brooks, who had risen from locomotive engineer to be master mechanic and superintendent of the Western division, was appointed superintendent of motive power and machinery of the entire system. Mr. Brooks proceeded with all the vigor of a clear, robust mind to work order out of the chaos that his department had fallen into; but the stupendous work was little more than begun when in 1869 he received from President

Jay Gould a lease of the Dunkirk shops for the purpose of forming a locomotive building establishment. The locomotive building shops was one of Mr. Gould's long headed schemes for encouraging local industries that would bring business to the Erie Railroad.

Several able men followed Mr. Brooks as head of the mechanical department of the Erie, among them F. K. Hain, F. M. Wilder and others, under whom the mechanical department has been kept abreast of modern requirements.



Frederick D. Underwood, Redeemer of the Erie

Facts relating to the present motive power of the Erie belong to the chapters dealing with modern locomotives.

### **Frederick D. Underwood, the Regenerator.**

It is probable that no railroad property in the country has passed through so many vicissitudes as the Erie Railroad Company, but it now appears to be surmounting the obstacles to prosperity so persistently thrown in its way. Under the able manage-

ment of Frederick D. Underwood the Erie has been regenerated and is taking its place among the leading trunk lines—a place it had lost through robbery operations. Mr. Underwood was elected president of the company early in 1901 and its fortunes have been steadily rising ever since.

Mr. Underwood is the finest representative of a modern railroad manager. He has worked as clerk, brakeman, conductor, foreman, superintendent and manager on different railroads, and it would be difficult to mention any detail of the railroad business with which he is not familiar. This knowledge and very comprehensive mental grasp combined have made him the master that had power to drag even the Old Erie out of the mire.

In the beginning of 1907 the Erie Railroad had 2,420 miles of track, 1,468 locomotives and 57,218 cars.

# Reading's Mark on the Locomotive

## CHAPTER XVIII.

### The Philadelphia & Reading.

The Philadelphia & Reading Railroad was one of the pioneers, having been chartered in 1833, and all through its history the various managements have displayed intelligent enterprise in the development of railroad motive power. The original charter gave authority to construct a line of 58 miles from Philadelphia to Reading and to extend towards Pottsville, provided the Board of Managers deemed such extension advisable. The company now operates 1,470 miles of track and has about 940 locomotives and 40,500 cars.

That long mileage is more concentrated than that of any other railroad on the American continent, twisting and turning in all directions, with Reading as a center. Its trackage touches all the coal lands in Pennsylvania and in no part does the distance much exceed one hundred miles from Reading.

No railroad ever was constructed with better prospects of a lucrative business than the Reading, but from a variety of causes the work proceeded slowly and it was five years after the charter was granted before any part was in operation. The road was finished to Reading in 1842.

Several railroads have trackage in the anthracite coal regions of Pennsylvania and do a good business in handling that kind of coal, but the Philadelphia & Reading is par excellence the anthracite coal road, and it was for the purpose of developing the anthracite coal measures that the line was projected.

### Burning Anthracite Coal.

As anthracite coal had the characteristics of an ideal fuel for locomotives, being cheap in the Atlantic Seaboard States, and free from smoke, there were naturally attempts made from the inception of railroads to utilize it. Yet twenty years after the first locomotive had been operated in the United States, wood was the fuel used by locomotives even when their principal work was hauling anthracite to market.

The Baltimore & Ohio had used anthracite to some extent with success in their locomotives with vertical boilers and forced draft. In fact, one of the early prejudices held by the public against railroads was based on the fear that they might poison the atmosphere by clouds of smoke. Peter Cooper used anthracite for fuel in the small engine Tom Thumb, which he had built for the Baltimore & Ohio. It had been used on the Beaver Meadow Railroad and other short lines in Pennsylvania, but very little success had been achieved with it on engines doing hard, continuous work. Early experimenters with coal burning locomotives moved on the theory that concentration was necessary to maintain a very hot fire, and their tendency was to provide limited grate area. It took long years of failure to convince the men in charge of American railroad motive power that anthracite, being a slow burning coal, needed a much larger grate surface than wood or bituminous coal to produce an equal amount of heat.

The Philadelphia & Reading Railroad was the principal anthracite coal carrying line in 1850, but at that time nearly all its locomotives burned wood. Various attempts had been made to burn anthracite but success was attained very slowly. The company had commenced operating with small four wheel Braithwaite engines, somewhat like the Camden & Amboy's John Bull, that had unusually small fire boxes, entirely unsuitable for the combustion of anthracite. For several years all the new engines put upon the road suffered from the defect of small fire boxes.

#### **Gowan & Marx Class.**

Although success in burning anthracite in locomotive fire boxes was slow in coming, the management of the Philadelphia & Reading acknowledged the importance of the matter, and as early as 1839 they contracted with Eastwick & Harrison for a locomotive that would burn anthracite coal. The engine built on this contract was the Gowan & Marx, illustrated on page 143. The boiler of this engine was of the Bury type, and the fire box had then the unprecedented length of five feet outside. There was about 10 square feet of grate area, which was then considered very large, but it was not sufficient to generate all the steam needed when burning anthracite. The engine was four wheel connected and proved very powerful for its dimensions, which were cylinders  $12\frac{1}{2} \times 18$  inches, driving wheel 42 inches diameter.

The engine hauled a train 40 times its own weight from Reading to Philadelphia over a level track, and that performance made

it famous all over the world. Ten more of the same kind of engine were immediately built for the Philadelphia & Reading, but they had not been long at work when we find that the company were experimenting with engines having larger grate area. By that time the engineering world was beginning to realize that, with its slow combustion, anthracite required a furnace with abnormally large grate area.

### **Locks and Canal Engines.**

About 1845 the Locks & Canal Company, of Lowell, Mass., built a lot of engines for the Reading. They were four wheel connected with a four wheel truck which carried too much weight, with the result that the engines were exceedingly slippery. They had other undesirable peculiarities. The valves were without lap and were driven from one rod connecting with an arm on the crank pin. The valve hooks were an upper and lower V, and the rocker shaft pins were on a straight line through center of rocker shaft.

These engines were particularly unsatisfactory, and Andrew Vauclain, who was then general foreman of the Reading shops, rebuilt them to suit his own ideas. He lengthened the boilers about four feet, put in valves with  $\frac{3}{4}$ -inch lap and redesigned the valve motion. After these changes the engines were highly efficient.

### **Andrew C. Vauclain**

was a particularly able mechanical engineer and was the father of the inventor of the famous Vauclain compound locomotive. He served his apprenticeship under old Johnny Agnew in Philadelphia prior to the advent of the locomotive, was one of the first workmen employed by Mr. Baldwin in the construction of the Ironsides and became his first travelling engineer in charge of taking out and setting up locomotives. He had various changes of occupation on several railroads and between times returned to his original employer, Mr. Baldwin. He was at one time General Superintendent of the Ohio & Mississippi Railroad, and under his supervision their first shops in Illinois Town, now East St. Louis, were constructed. He held several positions on the Reading Railroad, among the number being Master Mechanic of their Port Richmond shops. He was considered one of the original fathers of the locomotive in this country, and in addition thereto designed and built a number of special tools, such as wheels,

lathes, etc., for taking care of the repairs and construction work connected with locomotives. In 1856 he went with the Pennsylvania Railroad to their new shops in Altoona, at the suggestion of Mr. Baldwin, and remained there until his death, serving in several capacities suitable to his experience and age.

### Story of a Safety Switch.

The first master mechanic of the road was Thomas Simpson, a good mechanic with inventive tendencies. He invented a good



Andrew Vauclain

safety switch which was used very much on the Reading Railroad. It was an auxiliary rail alongside of the main line switch rail. When the switch was wrong, the main track rail came in line with the auxiliary rail and carried the wheel to a cast iron flanged extension which turned the wheel back to the main track. Besides using the switch without paying anything to the inventor, the Reading Company claimed it as their own property because it was invented while Simpson was working for the company. They not only claimed it for their own use but were preparing to put it upon the market, when the inventor interfered by an injunction that blocked the scheme and settled a question which has

come up repeatedly since that time, but has always been decided in favor of the inventor.

The switch matter ended Simpson's career on the road and he was succeeded by Lewis Kirk, who came from the Locks & Canal works and was responsible for the locomotives ordered from that company.

In those days the position of master mechanic was very anomalous on many railroads, and on the Reading he performed duties similar to those of the road foreman of engines of later times. Mr. Kirk seemed to be adviser to the general superintendent, while the work of the repair shops was managed by the various foremen.



Fig. 120. Nichols' Novelty

### Curious Anthracite Burning Locomotive.

In 1846 the operating of the Philadelphia & Reading Railroad was in charge of G. A. Nichols, a civil engineer, who held advanced views concerning the proper means for burning anthracite. He patented a peculiar form of locomotive to embrace his ideas of an anthracite burning engine. Working out of the details was done by Lewis Kirk. Up to that time the only locomotives burning anthracite successfully had unusually large grates and forced draft. Nichols, thinking that the boiler connecting with the frame carrying the power transmitting machinery of a locomotive could not be made sufficiently large, designed a boiler to be carried upon a carriage separate from the engine. The locomotive, Fig. 120, was called the Novelty, and justified the name. The boiler like part of the engine was a steam reser-



voir which received the steam from the boiler proper through a jointed pipe. The cylinders exhausted the steam into a condenser and drove a blower discharging into the ash pan. The boiler was of the return tubular form and had a large fire box with 36 square feet of grate area. The total heating surface was 1,085 square feet. The engine was a failure principally for want of the necessary adhesion, but the boiler details were badly worked out, for the fire could not be replenished while the draft fan was working, and it was necessary to stop to fire between

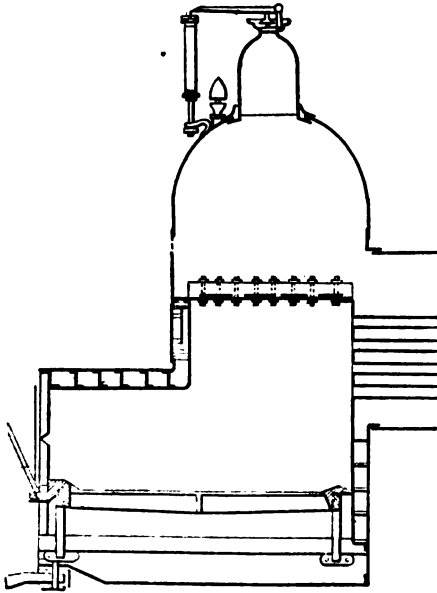

Fig 121. Winans' Firebox

stations. There have been few such glaring mistakes made in locomotive designing. Although the novelty was a failure it represented a most courageous attempt to reach a desired end.

### Winans Designs an Anthracite Burning Locomotive.

This enterprising attempt of the Philadelphia & Reading to produce a special form of anthracite burning locomotive stirred up the emulation of Ross Winans, and he immediately built four anthracite burning engines to compete with the Novelty. His engines, which were modified camels, had long overhanging fire boxes, Fig. 121, and they were not allowed to run on account of

the excessive weight on the back wheels. Winans then applied a pair of pony wheels under the foot plate and the engines were accepted. They burned anthracite better than any locomotives previously tried and were really the pioneer heavy anthracite burning locomotives to do the work of train hauling regularly, the large grate, having 17.68 square feet area, being their principal merit.

#### **Civil Engineer Employed to Advise on Burning Anthracite.**

The management of the Philadelphia & Reading Railroad were not entirely satisfied with Winans' design of anthracite burning locomotives, for we find that in 1849 George W. Whistler, Jr., a civil engineer of some repute, was employed by the president to investigate the question of anthracite burning locomotives. The report submitted was devoted principally to recounting the difficulties experienced in burning anthracite. In some respects his report bears a strong resemblance to others submitted years afterwards to the Railway Master Mechanics' Association by committees. Mr. Whistler reported that it was found anthracite made such a hot fire that it soon burned out the side sheets of the iron fire boxes. The iron not being free from seams, laminated and blistered so readily, that much expense was entailed. No remedy was suggested, but the company was advised to persist in the practice of using the fuel it was so much interested in carrying.

The employing of Mr. Whistler to report on anthracite coal burning was an act which testified to the influence of the civil engineer in those days. There was a strong tendency to place the knowledge of the man, whose principal experience had been the building of railroads and the digging of canals, above that of the mechanic who had designed, built and operated locomotives, even when it related to purely mechanical matters. The civil engineer's calling was old and that of the mechanical engineer scarcely recognized, so it was natural that the representatives of capital should show deference to the views of the civil engineer.

#### **James Millholland.**

At the time Whistler made his investigations, a master mind had been put in charge of the mechanical department of the Philadelphia & Reading, although his powers were not yet recognized. This was James Millholland, a master among the pioneer mechanics, whose labors have put an indelible mark upon the development of the American locomotive.

James Millholland was born at Baltimore, in 1812, and had time to learn the machinist trade, and held the reputation of being a remarkable bright boy and an ingenious mechanic, when Peter Cooper, in 1830, was building his Tom Thumb locomotive. Millholland worked on that tiny engine, and he no doubt acquired a strong liking for railroad motive power, since he devoted his life to that line of work, at a time when working on railroad machinery had not become popular. He had no more than attained his majority when he was appointed master mechanic of the Baltimore & Susquehanna Railroad, at that time one of the most important railroads in the world. His success was so marked that in 1848 he was appointed master of machinery of the Philadelphia & Reading, with charge of all rolling stock. The road was then ten years



James Millholland

in operation, having been constructed in a most substantial manner, with rails  $45\frac{1}{8}$  pounds to the yard, and a most substantial roadbed, at a cost of \$180,000 per mile. In spite of that enormous first cost, the road was doing a profitable business in 1850, for it was then carrying the heaviest traffic of any railroad in the country.

The engineering resourcefulness of Millholland may be judged from the fact that when he had charge of the machinery of the Baltimore & Susquehanna Railroad he resorted to the use of cast iron for cranks of inside connected engines. It was so difficult to make a good forging of a crank with the inferior tools used that breakages were of frequent occurrence, so he tried the weaker but sound material and it did not break.

### Difficulties Millholland Overcame.

When Millholland took charge the rolling stock was in a decidedly unsatisfactory condition, particularly the motive power. He proceeded to carry out the necessary improvements, almost the whole of the required changes having been evolved from his own head. There was little experience of others to draw from, so he was forced to depend upon his own resources to produce the designs best adapted for the work to be done. His controlling idea seemed in the first place to be the production of a locomotive to burn anthracite satisfactorily and then to design an engine capable of hauling a heavier train than anything tried up to that time. He succeeded in both of these aims, but success was achieved over some serious failures.

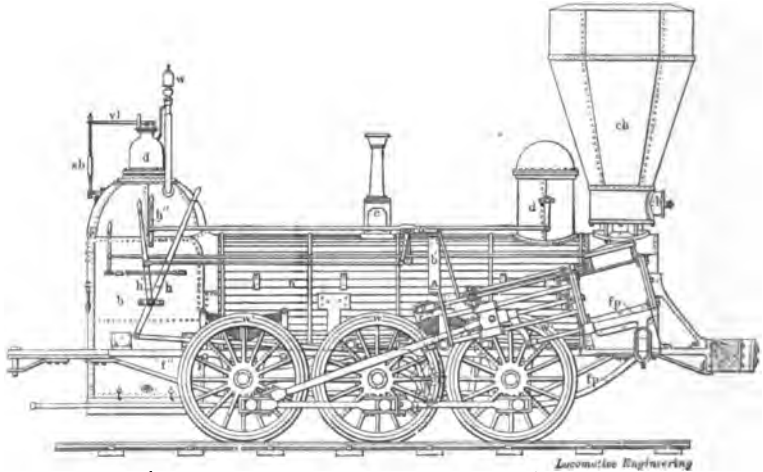

Fig. 122. Millholland's Philadelphia

Almost the first question put before Millholland was settling the fate of Nichols' Novelty. After making some tests with it he finally decided that the only purpose the engine could be used for to advantage was passing through the scrap heap, and this was done.

The first locomotive built by Millholland, about 1849, was the Philadelphia, a six wheel connected engine (Fig. 122), without a truck, in which no attempt was made to break away from the beaten path of early locomotive designing. His guiding idea was to produce a locomotive that would haul a heavy train of cars on a crooked track without undue resistance or injury to the track.

To attain these ends he placed the wheels as closely together as possible. The cylinders were secured outside of the smoke box and transmitted the power to the back pair of drivers, an arrangement that induced so much oscillation that the engine furnished good object lessons on defects to be remedied.

The fire box was the Bury style, which had been fairly satisfactory in the Gowan and Marx, the most successful of the first freight engines on the road; but it did not permit of more than 10 or 11 square feet of grate area, and hence was not well adapted to the combustion of anthracite. After obtaining experience with the Philadelphia new and original types were worked out.

### Finding Out Fittest Forms.

Before building any more new locomotives, Millholland made a variety of experiments with old ones to find means of burning anthracite successfully. He rebuilt a Baldwin eight wheeler, the Warrior, and made radical changes upon the fire box. The furnace was kept within the frame line until it reached the back of the hind drivers, when it was spread, reaching about five inches beyond the rail on each side. There was a grate door in rear of the fire box resting upon the grates, and it carried two doors to fire through. This was the first locomotive ever built with the fire box extending outside of the driving wheels and was the fore-runner of the Colburn, the Wootten and others. Many fire boxes of this type were afterwards applied to Belgian locomotives, and some of them may be seen at work to-day.

Millholland's wide fire box engine burned anthracite more successfully than anything previously tried.

### Some of Millholland's Mistakes.

The stationary boiler and marine practice of the time led Millholland to believe that a long flame passage was necessary to effect combustion in a locomotive furnace, and he worked very persistently with various forms of combustion chambers until he finally became convinced that they were actually prejudicial to the efficiency of the boiler. One of his first attempts was to produce an anthracite burning fire box that would not damage the side sheets, and with this object in view he patterned in 1852 a boiler, the special features of which were the use of dust plates contracting the area of grates for the purpose of preventing the overheating of the side sheets of the fire box, and the putting in of an intermediate

or mixing chamber, into which the products of combustion passed from the fire box between water tables or vertical water spaces, and from which after mixing with fresh air admitted through small holes, they passed through large tubes to a second combustion chamber and thence into the smoke box.

### Misleading Scientists.

The scientific engineering world was at that time very learnedly discussing the admixture of gases requisite to effect proper combustion of the fuel. Every engineering treatise of the time was loaded down with detailed directions for burning coal according to the most approved rules, and one injunction never neglected was, provide for a liberal supply of oxygen. This, no doubt, induced Millholland to provide for the admission of too much cold air.

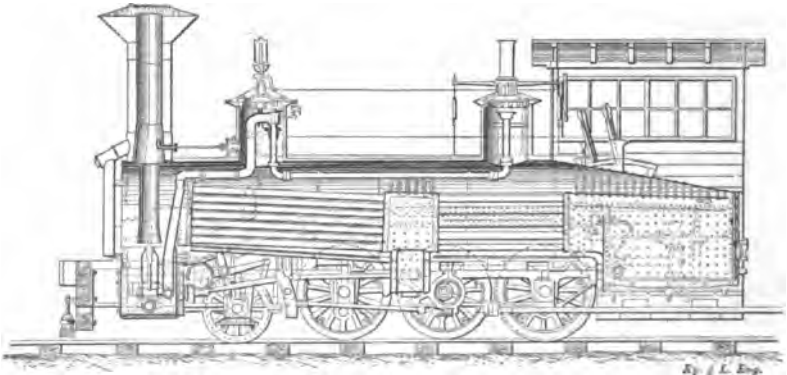

Fig. 123. Millholland's 6-Wheel Connected Engine, with His Patented Boiler (Pawnee Class)

### Pawnee Class.

In 1852 Millholland applied his patented boiler to seven freight engines, illustrated in Fig. 123, coupled with a single pair of small grinding wheels behind the cylinders. These engines were known as the Pawnee class, but the first one built was called the Wyoming.

This class of engine embraced the greatest advance in locomotive designing made up to that time. The wheel arrangement was the precursor of the Mogul, a single pair of leading wheels having been placed behind the cylinders, but secured in this case to the main frames. The necessity for leading guiding wheels in six-

wheel connected engines was no doubt impressed upon Millholland by his experience with the Philadelphia.

The boiler, however, possessed the most novel features, being the patented form already described, but further improved. The fire box was placed behind the back driving wheels, providing an unusually large grate. In front of the fire box was a water table, then a short combustion chamber, as shown. This was followed by a set of short flues, 3 inches diameter, which led the fire gases into a second combustion chamber, thence by small tubes into the smoke box.

The valve motion was a stationary link and shifting block with round eccentric rods fastened to the eccentric straps in a peculiar fashion. There were double slide valves and located almost at the

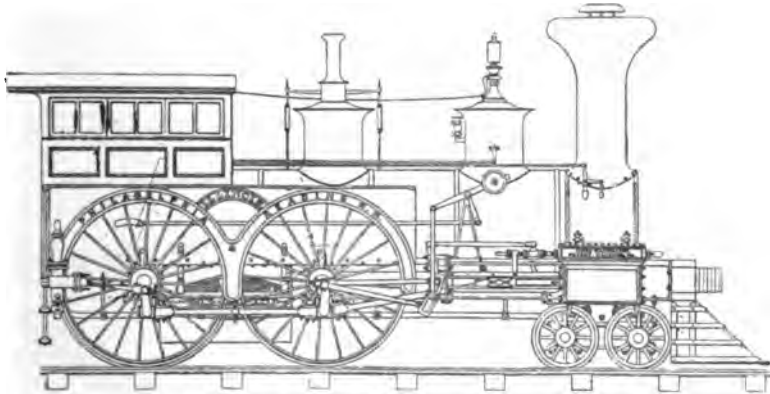

Fig. 124. Millholland's First Passenger Engine

end of the cylinder, for the purpose of shortening the steam passages as much as possible. This was done on many of the engines built by Millholland. The variable exhaust consisting of a movable cone which was lowered or raised by suitable rod connections, an arrangement that has been patented several times since Millholland applied it, notably by F. W. Webb, of the London & Northwestern Railway. The blower opening was to the side of the stack circle, which seems wrong, according to modern ideas, but it created the necessary draft. The smoke stack consisted of an inner and an outside pipe, the extra pipe in front having been provided to carry away whatever cinders accumulated between the inner and outer stack pipes.

There was a double seated throttle valve, one of the first on record as being applied to a locomotive. Two domes were used,

a convey pipe making connection between them. There are other peculiarities which can be found on a close inspection of the engraving.

In their time these engines were reputed to be the finest locomotives ever built, so far as finely proportioned machinery was concerned, but they had the fault of many other fine engines, they were very poor steamers.

### The Illinois Class.

Failing to profit by the defects of the Pawnees, Millholland applied his boiler to two fine passenger engines, the Illinois and the Michigan, shown in Fig. 124. A man who helped to build these engines asserts that they were the finest looking engines he had

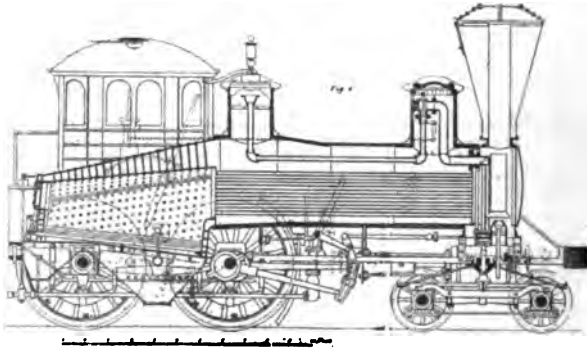

Fig. 125. Millholland's Anthracite Passenger Engine Hiawatha

seen up to that time and the work put upon them was the finest that good mechanics could produce.

The cylinders of these engines were  $17\frac{1}{2} \times 30$  inches, and the driving wheels, with wrought iron centers forged in the shops, were 7 feet diameter. The engine had the steam parts at the ends of the steam chests served by a valve for each set of ports.

When put into service the engines failed to generate sufficient steam to pull trains on time. The water table was taken out, but the combustion chambers were retained. Then the cylinders were bushed to 15 inches diameter. With this change the engines worked until they were worn out.

### Abandons Combustion Chamber.

Several other engines were built with modified combustion chambers, but by degrees the designer became convinced that it



was a detriment to the boiler instead of a help to steam making, and it was abandoned. The teaching of experience had been that liberal grate area and straight flues as long as practicable made the best combination for burning anthracite and that became the practice under Millholland.

After a time Millholland settled upon the eight wheel engines shown in Fig. 125 as the most satisfactory form of passenger engine. This engine was called the Hiawatha and possessed all the valuable features of the Illinois without the boiler defects of that class.

### Very Heavy Locomotives.

In striving to find the most powerful form of locomotive that could be made to work on a rail gauge of  $56\frac{1}{2}$  inches, Millholland



Fig. 126. One of Millholland's Developments

designed and built the Mountaineer class, which had five pairs of driving wheels 40 inches diameter and a rigid pony truck. The cylinders were 19x20 inches.

A serious objection to that size of engine was that they were destructive to the fragile cars then used for coal work. For pushing service on steep grades the Pennsylvania, Fig. 126, was built, which had six pairs of drivers connected and was a unique form of locomotive. The cylinders were 20x20 inches, wheels 46 inches diameter. The engine having given trouble on curves, it was rebuilt after being used a short time and the number of driving wheels were reduced.

### Cast Iron Tires.

Among the courageous things done by Millholland was using cast iron tires, which was done largely until steel was introduced.

They were used only on driving wheels of 46-inch diameter and less. Centers were made with six bosses on the felloes through which steel pointed screws passed and engaged in a counter sunk spot on the tire. The tires bored to gauge were slipped in place, the screws tightened, and the job was finished. The cast iron tires did not break any more than those made of wrought iron.

When James Millholland became master of machinery of the Philadelphia & Reading Railroad, the locomotive was very much in an experimental state, as a whole, and there was no harmony among builders concerning the material, dimensions and design of the component parts. It was common to have the cylinders secured high up on the sides of the smoke box, transmitting the power through long reaching rod connections; no approach at uni-

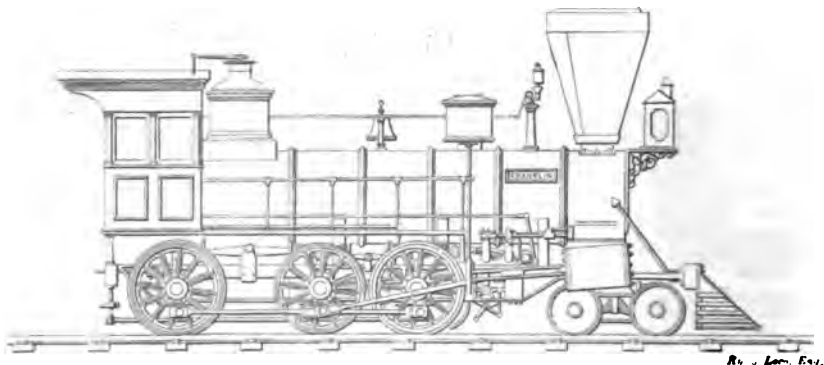

Franklin, Built by Richard Norris & Son, 1850, for Philadelphia & Reading

formity existed in the design of frames and running gear; bearings and valves and valve gear were often badly designed for the work to be done, while little intelligent attention had been bestowed upon the design of reciprocating parts with a view to controlling the disturbing forces imported to the driving wheels. Millholland's work, extending over eighteen years on the Reading, was largely devoted to remedying the defects of the crude locomotive. His work was on a level with that of M. W. Baldwin, George S. Griggs, Wilson Eddy, William Mason, Ross Winans and other engineers whose intelligent labors advanced the locomotive from a crude elemental machine to a well proportioned locomotive.

Millholland was the first designer to place the fire box of the locomotive above the frames, which was done on the Vera Cruz in 1857.

# The Lackawanna Railroad

## CHAPTER XIX.

### Ithaca & Owego Railroad.

The humble section of railroad which is the oldest of the scattered pieces that now constitute the trunk line and branches of the Delaware, Lackawanna & Western Railroad, originated

**ITHACA AND OWEGO**



**RAIL ROAD.**

NEW ARRANGEMENT WHILE FINISHING THE ROAD.

**TRANSPORTATION TRAIN.**

**The train of Transportation Cars will leave Ithaca every afternoon (Sundays excepted) at 4, and arrive at Gridley's at 8 o'clock. P. M., will leave Gridley's at 4, and arrive at Ithaca at 8 o'clock, A. M., stop here, both in going and returning, at Howe's Turnout, Whitcomb's and Wiley's Mills, to take in and discharge loading, and receive Cars that may be in readiness to join the train.**

**The train of Transportation Cars on the Owego end of the Road, will leave Owego every afternoon (Sundays excepted) at 5, and arrive at Gridley's at 8 o'clock, P. M., will leave Gridley's at 4 and arrive in Owego at 7 o'clock, A. M., stopping both going and returning at one's Cross Roads, Bechtel's and Chesley's Mills, at Canador Corners, and at Booth's Cross Roads to take in and discharge loading, and to receive such cars as may be in readiness to join the train.**

**No burden Cars are permitted to run upon the Road except such as are registered in the Secretary's Office in Ithaca, and have a Certificate of Fitness from the Engineer, and a way-bill of loading must accompany each car not belonging to the Company's Train, and toll paid at the Gates, at the rate of 3 cents per ton per mile.**

**DANIEL L. BISHOP, Secretary.**

ITHACA, July 20, 1898.

*Mack, Andrus & Woodruff, Printers.*

By Courtesy of "Railroad Gazette"

through the ambition of two small towns to make themselves active factors on a great transportation chain. The towns were Owego, on the Susquehanna river, and Ithaca, 34 miles distant, at the head of Cayuga lake. There must have been ener-

getic business men in these two towns, for they schemed to join the waters of the Susquehanna and of Cayuga lake by a railroad. so that people and merchandise westward bound could ascend the river to Owego, thence by rail to Ithaca, then down the lake to make whatever connection could be most easily established for Lake Ontario and the great western country then filling up with settlers.

The charter for the Ithaca & Owego Railroad was secured in 1828, being the second railroad charter granted by the New York Legislature, but the road was not built until 1832, a year after the Mohawk & Hudson Railroad was opened. The original intention was to operate the Ithaca & Owego Railroad by horses and two inclined planes, both at Ithaca. This practice was followed for eight years till 1840, when a small Norris type of engine, called "Old Puff," built by Walter McQueen, at Albany, was put into service.

The business anticipated for this road did not materialize, and it languished in financial difficulties till 1843, when it was re-organized into the Cayuga & Susquehanna Railroad, but the change of name did not bring prosperity. In 1849 it was incorporated into the Leggetts Gap Railroad, which inspired it with new life.

#### **Leggetts Gap Railroad.**

The Leggetts Gap Railroad was chartered in 1832 by a few enterprising men, whose ambition exceeded their financial ability, and the scheme languished until 1849, when it was taken up by a group of industrial giants who had settled in a mountain bounded valley known as Slocum's Hollow, where they built the City of Scranton. The mountains were covered with valuable timber and in the ground beneath were thick layers of anthracite waiting for capital and labor to convert it into fabulous riches.

Among the leaders who established homes in this valley so favored by nature were George W. Scranton, Selden T. Scranton, William E. Dodge, Jeremiah Clark, Dr. Andrew Bedford, Henry W. Drinker, John J. Phelps and others, whose names ought to have a prominent place among the pioneers who converted the forests and wilds of America into fertile fields graced by homes redolent of comfort and refinement.

#### **Triumphs of Individual Energy.**

The strong individuality of Americans has frequently exercised very powerful influence on localities where men of indomitable

will have been accidentally planted. Many towns and cities owe the fortune of rapid growth to a few pushing, energetic men, who happened to become interested when the character of the place was being established. On the other hand many locations whose surroundings favored for the making of prosperous cities linger in obscurity because the pioneers that controlled the fortunes of the place were "no account men."

Slocum Hollow was fortunate in the settlers it attracted at the crucial period. Colonel Scranton and his friends proceeded to put in operation iron works and a variety of industries that turned into marketable goods the raw material of the district. The products of the anthracite coal mines were also seeking customers. Then in course of time the leaders of the district went feeling for western markets, and in connection with such enterprises the Leg-

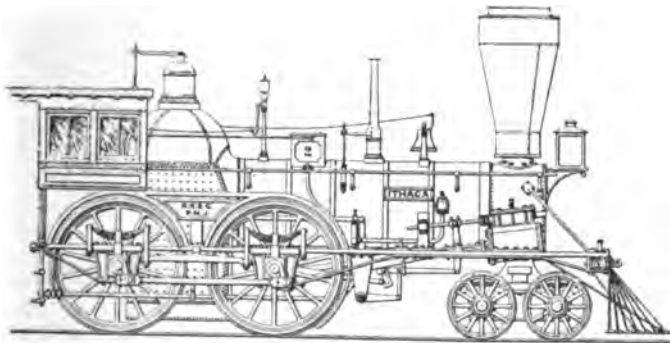

Fig. 127. Lackawanna's Second Passenger Engine, 1851

By Courtesy of "Railroad Gazette"

getts Gap Railroad, which had been chartered seventeen years before, was in 1849 promptly built to connect with the Erie Railroad at Great Bend.

Leggetts Gap is a depression in the mountain about two miles north of Scranton, and was the natural pass for a railroad to escape from the valley. Shortly after the Leggetts Gap Railroad was completed the company was reorganized and became the Lackawanna & Western. As the controlling purpose of the company was to connect with the Erie Railroad the same track gauge of 6 feet was established. The road when completed to Great Bend was  $48\frac{1}{2}$  miles long.

A considerable part of the construction work was done by animal power, but after a time the old Ithaca & Owego locomotive,

Old Puff, was put into service, and then one of the old Braithwaite engines was purchased from the Philadelphia & Reading. In this connection it is a curious commentary on the brevity of our railroad history to tell that E. J. Rauch, the man who brought that engine from Reading and ran it for several years is still alive and in robust health.

### Dotterer Becomes Superintendent.

About 1850 the Lackawanna & Western Railroad management engaged David H. Dotterer as superintendent and master me-

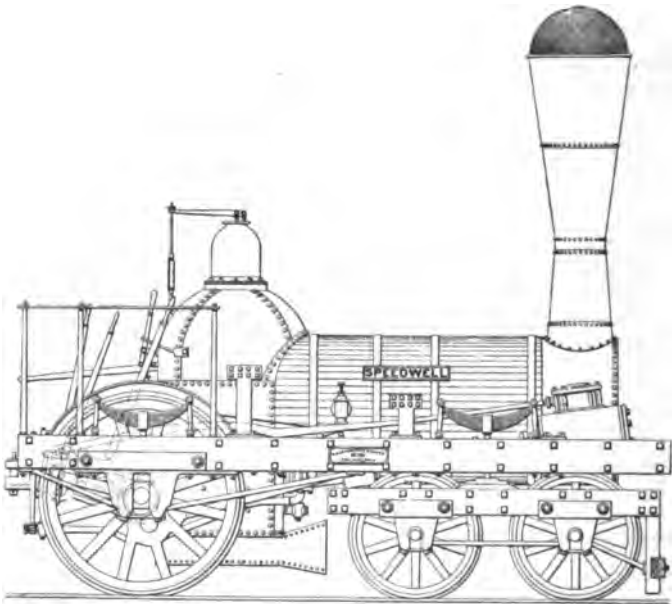

Fig. 128. Morris and Essex Third Engine, 1838

By Courtesy of "Railroad Gazette"

chanic. He had been for several years engaged in the building of rolling mill machinery at Reading, Pa., and like most engineering concerns of the day built locomotives when orders could be secured. Although it was apparent that the carrying of anthracite would constitute an important part of the railroad company's business, Mr. Dotterer ordered wood burners for the train service, which was commenced shortly after his appointment. The first new engine purchased was a Rogers eight-wheeler with outside cylinders 16x20 inches and driving wheels  $5\frac{1}{2}$  feet diameter. Then

orders were given to the same firm for some ten-wheel engines inside connected and they were delivered before the passenger engines. Orders were given later for engines from various makers, among them Danforth & Cooke, Swinburn, the New Jersey Locomotive Company, Ross Winans and others.

### Anthracite-Burning Engines Ordered.

About 1853 the management of the Lackawanna & Western wanted their freight locomotives to burn anthracite. The first coal burning engine received was almost a reproduction of Millhol-

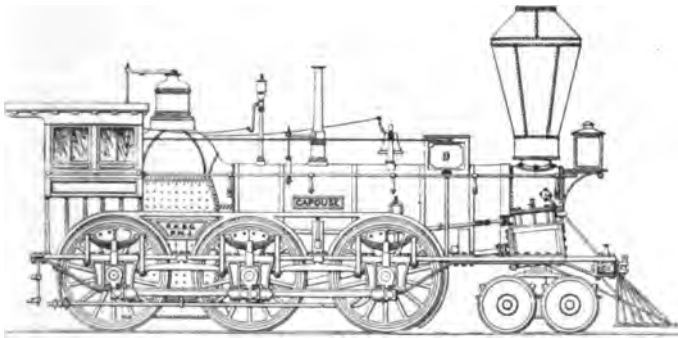

Fig. 129. Lackawanna's First Freight Engine, 1851

By Courtesy of "Railroad Gazette"

land's "Pawnee" class, illustrated on page 290. It had six wheels connected and one pair of small leading wheels behind the cylinders, and the peculiar boiler already described.

The engine was built by Danforth & Cooke, under the supervision of Watts Cooke, who afterwards gained celebrity as a mechanical engineer. He was appointed master mechanic of the Lackawanna & Western a few months after the engine was finished. He was assigned the task of taking the engine from Paterson to Great Bend by the Erie.

### The Winding Erie.

One of the leading engineers engaged on the location of the Erie held that curves on the track were things of beauty. The country through which the Erie runs, from Paterson to the Susquehanna river, provides ample occasion for curved track. When natural inequalities were made the best use of by an engineer, with an animosity to tangents, there were ample opportunities for mak-

ing a very crooked track. The wheel base of the "Anthracite," as this engine was called, was equivalent to that of an eight-wheel connection. It was not adapted for passing the sharp curves of the Erie, and the men in charge went through great tribulations in making the trip, as derailments were very frequent. The journey of 184 miles took about a week.

The Lackawanna was by no means a straight line in its course through the mountains of Pennsylvania, but it was not so bad as the Erie. Watts Cooke, however, concluded that it would be an improvement to convert the "Anthracite" into a ten wheeler, and that was done.



Watts Cooke

### **Ross Winans Supplies Anthracite Coal Burners.**

The "Anthracite" was not a success as a hard coal burner, but that did not discourage the management. Ross Winans, who was generally in evidence when a difficult problem in locomotive engineering was to be solved, succeeded in selling to the Lackawanna people a camel engine with elongated fire boxes, which burned hard coal very successfully. This engine weighed about 56,000 pounds and had cylinders 22x22 inches, and four pairs of cast-iron wheels 43 inches diameter, with no truck. This engine hauled heavy coal trains at slow speed quite satisfactorily. The result was that five other Winans engines were purchased.

These Winans camels were unpopular with the engineers, who did not take kindly to sitting on the top of the boiler. They were



all except one scrapped in 1859 on account of boilers not being considered safe.

In 1854, when the New Jersey Locomotive & Machine Company were invited to build coal-burning engines for the Lackawanna road, Zerah Colburn was designer and mechanical engineer for the locomotive builders. Colburn was one of the most celebrated men the United States has nurtured. Some of the engines which he designed were masterpieces of advanced locomotive engineering.

### Zerah Colburn.

Zerah Colburn was born on a farm near Saratoga Springs, N. Y., in 1832. His father died during the son's infancy and the

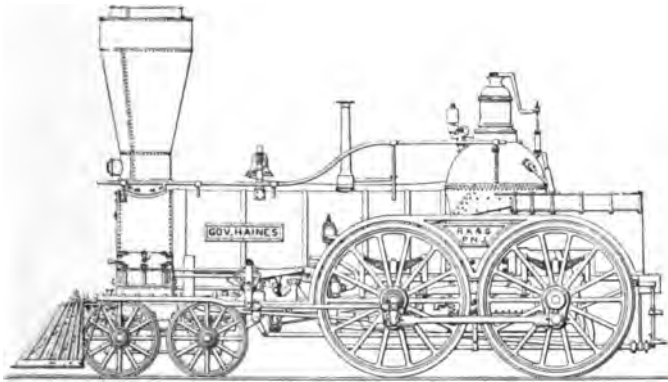

Fig. 130. Sussex Railroad Passenger Engine, 1854

By Courtesy of "Railroad Gazette"

mother removed to a small farm in New Hampshire, where Zerah spent his boyhood taking his share in helping with the farm work even at an early age. The first education he received was at the common school of the district where his mother's farm was located. The book training was very meagre, but Zerah had within himself the attributes that attract knowledge from all the surroundings in which the individual may be placed.

He had a strong bent toward mechanical pursuits which landed him in the Lowell Machine Shops as an apprentice when he was 15 years old. These, originally the Locks & Canal Works, were the oldest locomotive building establishment in New England. Little is known of young Colburn's opportunities in the Lowell works, but it is certain that within a few years he became one of the most expert draughtsmen in the United States. For a time he worked

in the machine shops of the Concord Railroad, then he went to Souther's locomotive building works, where he was for a time superintendent. Several other positions he filled with much credit as mechanical engineer, but his fame rests on his literary ability and his achievements as a writer on mechanical subjects. When little more than a boy, Colburn began writing articles to the current technical journals about the work he was engaged on. These soon began to attract attention through their elegance of diction and lucidity of description. He was an excellent mechanic and a very accomplished draughtsman, but the consciousness grew gradually upon him that writing was his forte, and engineering journalism became his life's work. A peculiarity of Colburn's writings was that he made stories about engineering details read like interesting

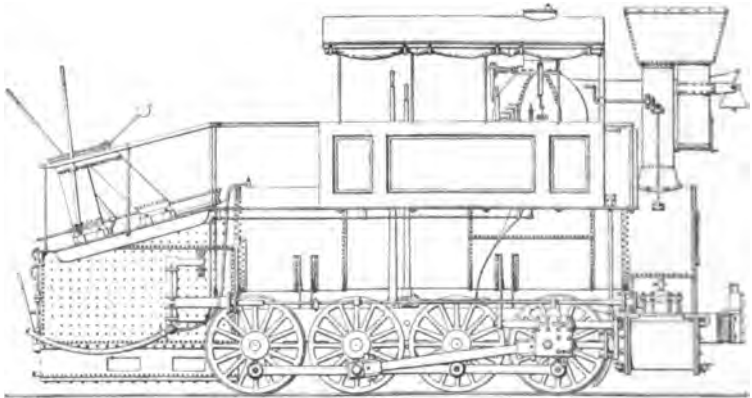

Fig. 131. Ross Winans Carbon for Lackawanna, 1854

works of the imagination. His articles and books educated people into the practice of reading technical literature with pleasure.

Colburn's principal literary labors were editing Colburn's Railway Advocate, editing the Engineer, of London, originally the Engineer, of Philadelphia, and in originating and editing London Engineering. The most permanent monument of his genius and industry, however, is his book on "Locomotive Engineering and the Mechanism of Railways."

The success of a man like Colburn ought to be an inspiration to boys who have to make their own way in the world. See him a farm boy moved by an inner pressure toward a wider life. See the boy working in the machine shop during the day and at night burning the midnight oil over the drawing board, training his hand to

the touch of an artist draughtsman and reading the select literature that made this engineering editor a wonder among the masters of classic English.

Zerah Colburn had an uncle of the same name, who was a famous mathematician. People writing about the famous engineer and editor have frequently confused his work with that done by his uncle.

### Colburn's Wide Fire Box Engines.

As a journalist Colburn devoted much attention to the operating of the locomotives in different sections of the country and his analytical mind busied itself with the causes of the diverse performances of the locomotives in use. The experience he had and the experiments he was able to carry out convinced Colburn that most of the American locomotives suffered from too limited grate sur-

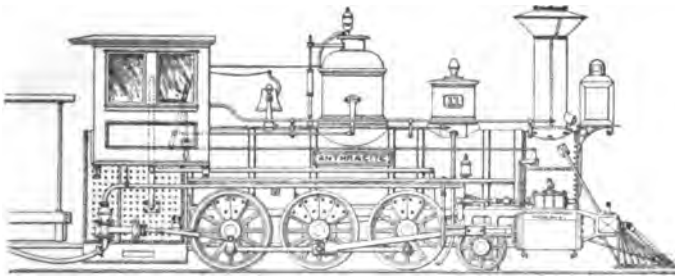

Fig. 132. Lackawanna's First Hard Coal Burner, 1854

By Courtesy of "Railroad Gazette"

face. While holding the position of mechanical engineer with the New Jersey Locomotive & Machine Company he turned his attention to enlarging the fire boxes, a move he had strongly advocated in his writings. He had a group of engines built for a railroad in Canada with fire boxes wider than the track gauge. Assured by the success of these engines he then designed some engines for the Lackawanna with fire boxes 7 feet 6 inches wide and 6 feet long, providing 45 square feet of grate area.

These engines as originally designed are illustrated in Fig. 133. They were very powerful engines for the time, having cylinders 18x24 inches, and a boiler with ample heating surface to supply the cylinders with steam.

About the time that they were ready to begin building the engines, Mr. Colburn left the New Jersey Locomotive & Machine Company, and the builders changed the design somewhat, for one

thing shortening the fire box to  $4\frac{1}{2}$  feet and putting in a combustion chamber. John Brandt was then superintendent of the works. The engine as delivered to the Lackawanna in 1855 had cylinders  $18 \times 24$  inches, six coupled driving wheels, 4 feet diameter, straight boiler, 50 inches diameter, with dome 30 inches diameter, and 28 inches high. The fire box was  $7\frac{1}{2}$  feet wide,  $4\frac{1}{2}$  feet long, and had combustion chamber 4 feet long. The flues were 3 inches

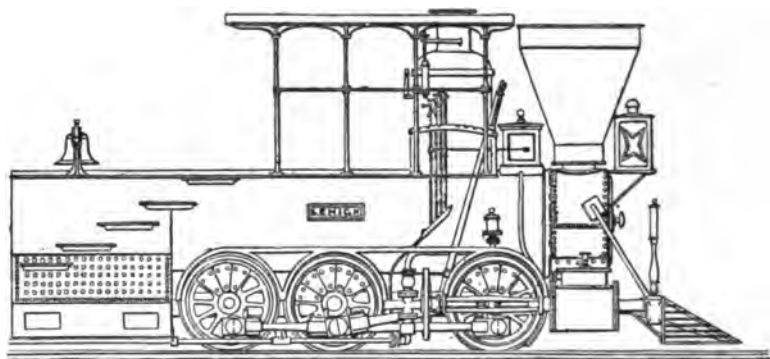
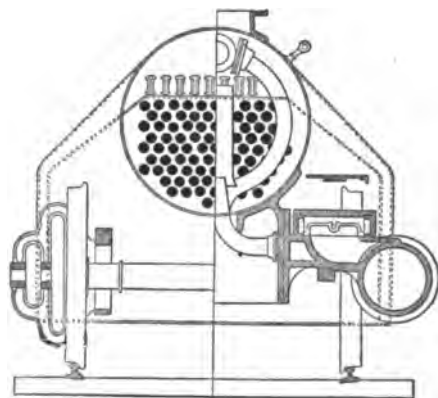

Fig. 133. Colburn's Wide Fire Box Engine. 1855



End Section of Above

diameter and 10 feet long. The material used in construction was lighter, the shell having been made of iron .28-inch thick, and fire box of  $\frac{1}{4}$ -inch iron.

After considerable experimenting this engine was changed, the fire box having been lengthened to 6 feet, and  $2\frac{1}{2}$  inch tubes substituted for the larger size. A variable exhaust was supplied, consisting of a plug which could be raised or lowered from the cab.

Mr. Henry F. Colvin, of the Rue Manufacturing Company, Philadelphia, ran one of the engines for some time, and he states that it did not steam satisfactorily until the fire box was lengthened to the size originally designed by Colburn.

Colburn's "Lehigh" was not any more popular with the locomotive department than were those built by Winans. A departure from established forms always excites prejudice among enginemen. Five more of them were ordered, but they never became popular. Long fire boxes were eventually applied to them, the Lehigh having been changed in 1863, and the others afterwards.



Henry F. Colvin, One of the Lackawanna Pioneers

### Question of Who Originated the Wide Fire Box.

A historical question is involved as to how far Colburn's form of boiler and fire box influenced the design of the Wootten fire box and of other similar forms without combustion chambers. Many of the wide fire box engines in use to-day are what the Colburn fire box would have been with the frames carried back under the fire box and the latter spread over the driving wheels.

In regard to the influence which the Colburn fire box exerted on the development of the Wootten and so-called "Mother Hubbard" fire boxes, I place a high opinion on the views of Mr. Henry

F. Colvin, who was an engineer on the Lackawanna and ran several of the engines with the Colburn fire box. Mr. Colvin writes me:

“There is no doubt in my mind that Colburn’s wide fire box was an important factor in the introduction of the wide fire box now so generally used on the Delaware, Lackawanna & Western and other railroads. The only objection to the original Colburn fire box was that it did not allow for a decent arrangement of coupling the engine to the tender, and the overhang caused a tendency to ‘wobble’ the engine while running. While I was running the ‘Investigator,’ which had a Colburn fire box, Watts Cooke, the master mechanic, had several talks with me about this very matter, and he could not see any way to overcome the long coupling bar.



Fig. 134. Lackawanna's First Successful Hard Coal Burner  
By Courtesy of "Railroad Gazette"

“After the present type of fire box had been adopted, I was in the shop at Scranton and saw my old friend William Connell, who was then general foreman. He asked me to go into the boiler shop to see a new kind of boiler they were making. On the way we met James Hughes, foreman of the boiler shop, who said they were making a new boiler for the ‘Investigator,’ and that it had the old Colburn style of fire box without a combustion chamber.”

Mr. J. Snowden Bell, Patent Attorney at New York, who is very well acquainted with the development of the locomotive, thinks that Mr. Wootten was influenced more by the Millholland than the Colburn form of fire box when working out his designs.

### Southern Extension of the Lackawanna.

Writing the history of any particular railroad is not the purpose of these articles beyond what its influence may have been on

the development of the locomotive engine; but it may be mentioned that the promoters of the Lackawanna Railroad were not long satisfied to have their outlet restricted to the West. After several years of agitation, work on a southern extension was begun in 1853. The enterprise was of an exceedingly formidable character, for the towering Mount Pocono barred the way almost at the beginning, and that was followed by trackless forests through a savagely broken country to the Delaware river. The Warren Railroad, 21 miles long, was utilized to make connection with the Central Railroad of New Jersey at Bridgeville, and for a time this was the route followed to the Atlantic seaboard.

At the time the southern extension was undertaken, the Lackawanna became the Delaware, Lackawanna & Western Railroad. In 1868 this company secured control of the Morris & Essex Railroad, and thereby obtained direct connection with the Hudson river.

#### Efficient Danforth & Cooke Engines.

Returning to the locomotive development on the Lackawanna system: The Lehigh was followed by the "Delaware," received in 1855, from Danforth & Cooke. The boiler was 46 inches diameter and had a dome 32 inches diameter and 34 inches high; fire box 5 feet long and 6 feet wide, with a combustion chamber 42 inches long, flues  $2\frac{1}{2}$  inches diameter. The cylinders were 18x24 inches, three pairs of coupled wheels 4 feet diameter, and no truck. The valves were between the cylinders and were operated direct, transmission bars from the links spanning the forward axle.

During 1855-6 five more hard coal burning engines were received from the New Jersey Locomotive & Machine Company that were very nearly the same type as the Lehigh. Then came the "Black Hawk," built by Danforth & Cooke, which was similar to the Delaware with a few would-be improvements added. There was a mid-feather in the fire box similar to that used by McConnell, of the London & Northwestern Railway. There was also a combustion chamber, on each side of which were arranged air holes, made by inserting a short piece of 2-inch tube from the shell of the boiler. These air holes were arranged in a horizontal line about 3 inches apart, having a frame around them with a damper in the form of a slide with holes to correspond with the air tube openings. This arrangement was intended to let in the air necessary to complete combustion, the damper being the keystone of the invention.

### An "Improved" Boiler.

The engine proved to be the best steamer on the road, and it was supposed that a new era in coal burning had arrived. One of the first things the engineers learned in handling this engine was to keep the air tube dampers closed tight all the time. To admit air was to dampen the free steaming. Very soon the dampers fell into innocuous desuetude, and their connections were removed.

Then the mid-feather began to leak and it was removed as an experiment, and a patch was put over the crown sheet opening with square-headed tap bolts for convenience in taking out when a new mid-feather was ready. The engine went out on the road for trial and steamed as well as it did with the mid-feather on, so it ran that way for eight years, till the fire box had to be renewed.

In 1857 Danforth & Cooke delivered two more engines to the company that resembled the Black Hawk without the "improvements," but with the boilers lengthened to get a four-wheel truck under the smoke box, making them ten-wheelers. These engines proved entirely satisfactory so far as steaming was concerned, the only weak point about them being the arrangement for coupling the tender. They ran many years before being modernized and there have not been any engines built since that showed more economy of fuel.

I am indebted to Henry F. Colvin for the facts about these engines.

### William H. Truesdale.

The Lackawanna, like nearly all trunk lines, absorbed a variety of short railroads that became feeders to the main stem. The company now has 952 miles of track, 675 locomotives and 30,000 cars. It is one of the most important anthracite carrying roads and has always been managed so wisely that it is one of the best railroad properties in the world. Under the able management of William H. Truesdale the value of the property has been greatly enhanced in the last seven years and very extensive improvements have been effected.

### Morris & Essex Railroad.

An important eastern connection acquired by this company was the Morris & Essex Railroad which was chartered in 1835. Work of construction was commenced in 1837, and the road was completed from Newark to Morristown, N. J., a distance of 22



miles, in 1838. Two locomotives built by Seth Boyden, mentioned in Chapter XVI., were the first motive power.

### Temperance for Railroad Builders.

A curious injunction was entered upon the agreement with the contractor of construction which read:

“For the preservation of peace and good order, to prevent riots and brawls and other disturbances along the line of this work, it is mutually agreed that no ardent spirits, nor any kind of intoxicating drink, shall be permitted by the contractors, who hereby pledge themselves to use all proper endeavors and to exert their best influence to prevent its introduction and use among the laborers employed upon the work.”

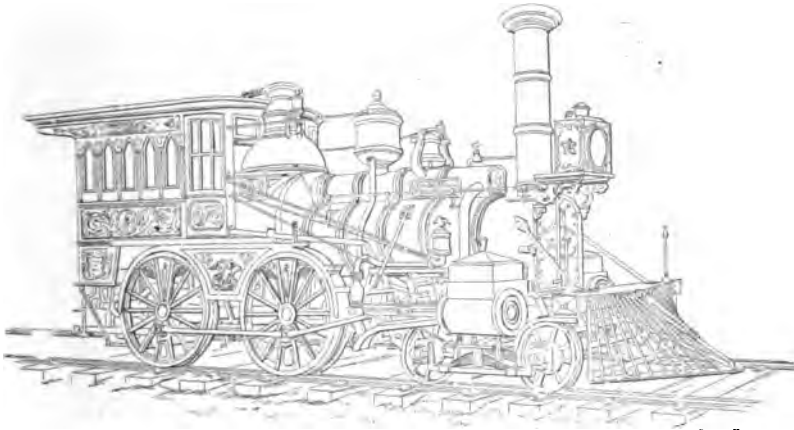

*Fig. 135. Loco. Eng.*

Fig 135. "Wyoming," Built by Richard Norris & Son, Philadelphia, for Lackawanna & Bloomsburg Railroad in 1857; Phleger Boiler and Water Grate

The first arrangement made by the Morris & Essex Railroad to reach Hoboken across the Hudson from New York City was by running over the New Jersey Railroad & Transportation Company's track, now part of the Pennsylvania Railroad. An extension to Hoboken was made in 1857. Extensions westward were pushed year by year till in 1867 Phillipsburg, 84 miles from Hoboken, was reached. In 1868 the Morris & Essex was leased by the Delaware, Lackawanna & Western Railroad Company, which used it as the Eastern connection with New York.

In 1870 what is known as the Boonton Branch was built which extends from Dover, N. J., by Paterson to Hoboken. The grades

are much easier than those of the Morris & Essex and that branch is now used as part of the main line.

The Delaware, Lackawanna & Western Railroad was always noted for keeping the motive power up to the latest designs and no road in the country has better locomotives, or engines that are kept in such splendid condition.



W. H. Truesdale, President Lackawanna  
Railroad System

# The Lehigh Valley Railroad and Its Motive Power

## CHAPTER XX.

### Stupendous Undertaking.

When Hannibal undertook to cross the Alps with a great army, he entered upon an achievement in travel of unparalleled difficulty. If the great Carthaginian general had advisers they doubtless did their best to deter their chief from his purpose, and the lower elements of the army, who had not reached the dignity of being advisers, no doubt sneered at and criticised the enterprise, which they felt certain would end in disaster. Such is the reception given to all uncommon projects.



On The Lehigh Valley

Early in the year 1852 a group of enterprising men entered upon the work of constructing a railroad through the Alps of America, from Mauch Chunk to Easton, Pa., an undertaking much more formidable than the work of transporting 100,000 soldiers over the Italian Alps. The railroad project was embarked in for the purpose of gathering some of the natural riches of the Lehigh Valley, but the ambition of the promoters received

scant sympathy and small financial support. Building railroads through mountain obstacles had not yet become popular. A recent writer recalling the discouragement that depressed this enterprise, says:

### Genesis of the Lehigh Valley Railroad.

“The early days of the Lehigh Valley Railroad were days of tribulation. There was lack of encouragement and lack of financial help. Skepticism of the feasibility of the project ruled in Lehigh Valley communities, and both skepticism and ridicule were meted out to its projectors by outside critics. Expressions of good will and wishes for success were not entirely absent, but the helping hand was withheld.”

The original preliminary survey of the Delaware, Lehigh, Schuylkill and Susquehanna Railroad, under which name the Lehigh Valley Railroad was incorporated in 1846, was made by Roswell B. Mason for a number of citizens living in New Jersey. There was a vague idea among them that the railroad would be used to convey coal and merchandise to the four rivers named in the charter for transport to the ocean, thence to the world of commerce. When, however, the incorporators came to investigate the character of the country to be traversed by their railroad, they lost courage, and the scheme was abandoned and lay dormant for several years.

In 1852 the charter was secured by Asa Packer, who had an unwavering faith in the resources of the Lehigh Valley, with the inflexible determination to utilize them. His foresight and faith in the enterprise in the face of difficulties that would have appalled most men, were backed by splendid courage and a tireless energy, which won victory for him and the faithful band of brave spirits who co-operated with him. The name of the road was changed by act of legislature in 1853 to the Lehigh Valley Railroad.

Asa Packer and the Chief Engineer Robert H. Sayre were the active powers of the road. Upon their shoulders rested the responsibility and work. The two represented the functions of all the departments that make up a railway organization of to-day; the one, the executive and financing departments, the other, the construction and operating departments. The little as well as the big things demanded their personal attention, exacting of them eternal vigilance.

### Mauch Chunk Inclined Plane.

New England is proud to claim the honor of having had within its borders the first railroad in America to carry wheeled vehicles. Pennsylvania comes next with its famous gravity railroad, opened in 1827, from the Lehigh River to Mount Pisgah, a peak of 1,500 feet above sea level, in the heart of a rich anthracite region. This inclined plane railroad was built for the transportation of

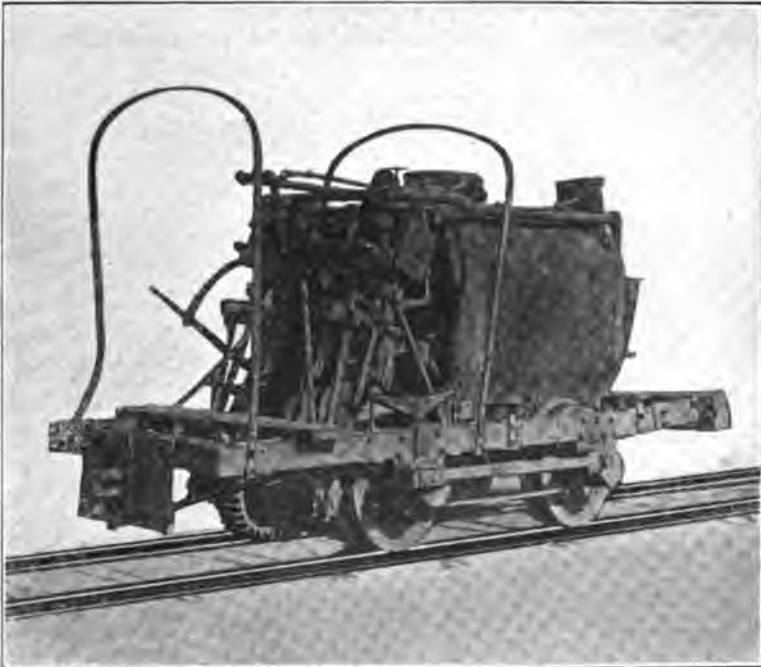

Fig. 136. Grice & Long Locomotive

coal to the river. It is now operated as a scenic railroad and draws multitudes of visitors every summer.

When we come to regard its oldest member as an integral part of a consolidated railroad system we have to credit the short, tortuous, inclined plane of Mauch Chunk as being the most ancient part of the Lehigh Valley Railroad.

### Beaver Meadow Railroad.

Another possession of ancient origin was the Beaver Meadow Railroad, which was projected in 1830 and put in operation in

1836. That was a famous little railroad in its day. Its purpose was to transport anthracite coal from the mines near Beaver Meadow in the Mauch Chunk region for shipment on the Lehigh Canal. Its location was through a remarkably rugged mountain district, where it wound by steep hillsides, over torrential streams, through swamps and forests by a route that involved the greatest difficulties of construction then encountered in railroad building. Although there was no direct connection between the undertakings the construction of the Beaver Meadow Railroad was a fitting introduction to the building of the Lehigh Valley Railroad.



Alexander Mitchell, Designer of First Consolidation Locomotive

The Beaver Meadow Railroad was as famous for different locomotives it possessed, as was the Lehigh Valley for the novel forms its people produced, in developing locomotives adapted to hauling heavy loads over steep grades.

The first locomotive that belonged to the Beaver Meadow Railroad was called the Samuel D. Ingham, after the president of the company, and was notable among the railroad motive power of that time. It was built by Garrett & Eastwick, of Philadelphia, was of the eight-wheel type, had a peculiar valve motion designed by Andrew M. Eastwick, reversing being done by a block sliding on the valve seats, and it was the first locomotive

in Pennsylvania to be provided with a cab for sheltering the engine crew.

### Extension and Consolidation.

The first section of the Lehigh Valley Railroad was no sooner opened than the company was flooded with business far beyond the most sanguine expectations of the promoters. At the head of the company were men of a pushing, enterprising character, who perceived the golden opportunities that their inroad into virgin territory had brought forth and they proceeded to make the best of them. A policy of extension and consolidation was adopted, and the management proceeded gradually to the absorbing of fragmentary roads calculated to be worked up into a great trunk line.

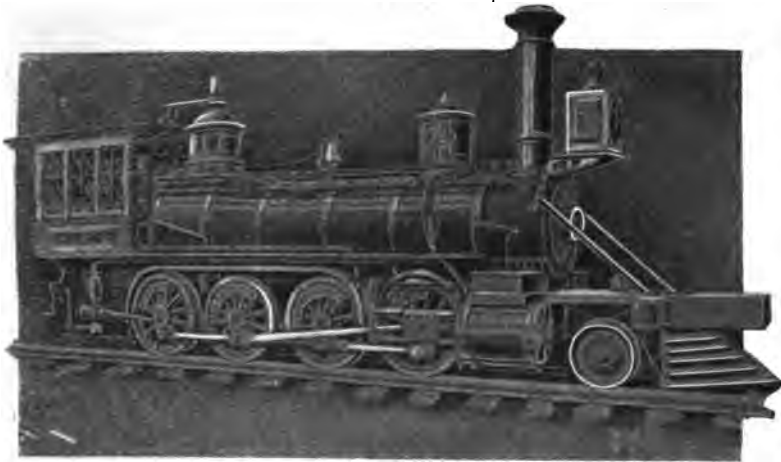

Fig. 137. Alexander Mitchell's "Consolidation"

In 1864 the Lehigh Valley Railroad Company absorbed the Beaver Meadow Railroad, an important move, for it took away a competitor and secured a valuable feeder from the richest anthracite regions. A few months later a consolidation was effected with the Penn Haven and White Haven Railroad. In 1866 another consolidation was effected, and the Lehigh and Mahanoy Railroad became part of the Lehigh Valley Railroad. This consolidation gave the name to the type of eight-wheel connected and leading pony truck locomotive designed by Alexander Mitchell and built that year. At the same time was purchased the North Branch Canal, extending from Wilkes-Barre to New York State line, a distance of 105 miles, with the privi-

lege of laying a track the whole distance. Other consolidations and absorptions followed, and now the Lehigh Valley Railroad Company operates about 1,400 miles of track, with about 800 locomotives and 40,000 cars.

### Grice and Long Locomotives.

The principal freight handled by the Lehigh Valley Railroad Company has always been coal and other minerals. The mechanical officials from the first displayed a leaning toward heavy motive power that would handle economically heavy freight over the steep grades. Before discussing particulars of their progress in this line, I wish to allude to a peculiar type of mine loco-

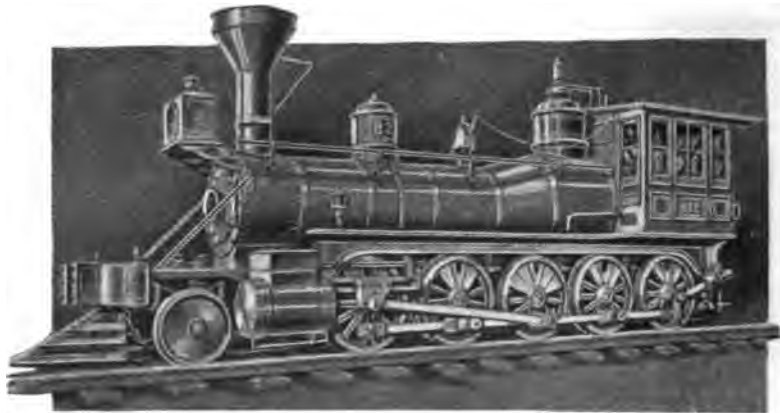

Fig 138. "Bee" Locomotive, with Ten Driving Wheels

tives used on some of the branches. Fig 136 illustrates one of these Grice and Long locomotives, which was at work at Packer No. 4 Colliery at late as 1901.

This was a four-wheeled locomotive, with built up frame. The boiler, which is of the internally fired, return tubular type, is placed over the front pair of wheels. The cylinders, which are placed nearly vertical over rear axle, are in the rear of the boiler. The connecting rods drive a cranked shaft on which a gear is placed. This gear in turn drives a pinion on rear axle. The wheels are inside the frame, and axles are cranked for parallel rods. Only the rear pair of wheels are equipped with springs. Shifting or so-called Stephenson link motion was used, and the lost motion in parallel rods was taken up on one end by taper key, on the other by a set bolt lock nut.



In spite of very persistent search, I have been unable to find out who designed these extraordinary locomotives, but it certainly was a man with some engineering ideas, the leanings being towards marine practice. They were evidently patterned somewhat after the Baltimore and Ohio Grasshopper engines, being made so short and compact that they would go round any curve, but the boiler was of a decidedly better form and the engine was likely to do its work on less steam, while it was very convenient for repairing.



Fig. 139. Hoffecker's 4-8-0 Engine

### Early Four Cylinder Engines.

Among curious locomotives possessed by the Lehigh Valley were two called the "Defiance" and the "Champion," built by the Niles Locomotive Works of Cincinnati, and purchased by the Beaver Meadow Railroad Company in 1857. They were designed for service on an inclined plane and had cog gearing for working on a rack rail. There were four cylinders, two inside and two outside, had four pairs of driving wheels connected outside, but no truck. They were equipped with the Walschaerts valve motion, or a radial motion of a similar kind, which was used all the time the engines were kept in service, probably twenty years. The engines were bought in Cincinnati at sheriff's sale, and were taken by river and canal to Penn Haven, thence to Weatherly by rail.

This information came to me from Alexander Mitchell, of Wilkes-Barre, Pa., who was long an official of the Lehigh Valley

Railroad, and put a permanent imprint upon the motive power of the world.

The first passenger engines belonging to the Lehigh Valley from 1855-1859 were wood burners; all freight engines burned coal. Wood burning locomotives were in use on that system as late as 1869, a curious practice to exist on a strictly coal carrying railroad.

In 1856 three engines with Phleger patent boilers and Norris cut-off valve motion were purchased of Norris & Son, of Philadelphia. As an evidence of the satisfactory performance of these



Fig. 140 "Audenried," with Clark's Independent Cut Off

engines a record of tonnage hauled is taken from the president's report for the year ending January, 1858: "During the six months from April to September, inclusive, the engine 'Catasauqua' ran 11,236 miles, and hauled 11,231 loaded and 11,246 empty cars of 5 tons each. In the month of July the engine 'Lehigh' made 26 round trips with an average load of 535 tons of coal per day." It is interesting to compare the performance of these engines with the present rating of freight engines over this same division.

The "Catasauqua" and the "Lehigh" were six-wheel connected drivers with a four-wheel leading truck and weight about 46,000 pounds.

#### Norris and Mason Engines.

In 1856 the E. A. Packer was purchased from Wm. Mason, of Taunton, Mass., and that builder continued to supply loco-

motives to the road as long as he lived. This engine was used in passenger service and was equipped with the Boardman boiler. The peculiar construction of the Boardman boiler required the use of eccentrics on a return crank attached to the main pin. This engine was also equipped with a "Low Moor Iron" fire-box, which was in constant use for eleven years without renewal. This was considered at that time the best obtainable material for fireboxes.

From 1855-66 the majority of the engines in use were either from Norris or Mason. There were some Baldwins, and a very few Brandt engines, built at Lancaster, Pa. James A. Norris was proprietor of the Lancaster Locomotive Works and John Brandt superintendent.

The Mason engines were favorites among the enginemen. They had the main wheel forward, which made them flexible on curves

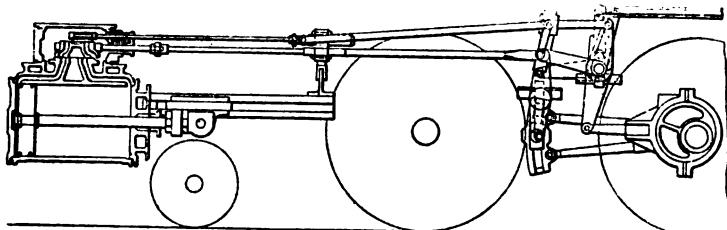

*Fig. 3 Loco. Eng.*

Fig. 141. Clark's Independent Cut-Off Motion

and free from nosing. They were very good steamers and powerful engines for their weight, the draw bar between engine and tender being offset so that in starting a heavy train part of the weight of the tender was thrown on the drivers.

The Norris engines, and also the Brandt engines, were equipped with the Hinkley cut-off, which had to be thrown in and out while the engine was in motion.

### Ready to Adopt Improvements.

All throughout the history of the Lehigh Valley Railroad it may be noticed that the men in charge of the rolling stock were always ready to adopt improvements and this company was among the first to reap the saving from a variety of inventions whose purpose was to reduce the cost of fuel and repairs, to prevent accidents, and to increase the comfort of train men.

By the time that the year 1865 opened the company possessed

a rather heterogeneous supply of locomotives, the aim evidently being to try all sorts to find out which kind produced the best results. R. Norris, Baldwin and Mason had been the principal builders, but there were engines from Brandt, of Lancaster, Pa.; Trenton Locomotive Works; Niles Locomotive Works, Cincinnati, Ohio; New Jersey Locomotive Works, Paterson, N. J.; Danforth & Cooke, Paterson, N. J.; A. Pardee & Co. and J. A. Norris.



Fig. 142. Strong's "Duplex" Locomotive

### **Master Mechanics Invited to Design Locomotives.**

About this time the management put upon the master mechanics the responsibility of producing locomotives especially adapted for the peculiarities of the system. The first result of this movement was the designing of the consolidation form of engine (Fig. 137) by Alexander Mitchell, master mechanic of the Mahanoy Division. That was in 1866. The engine was built by the Baldwin Locomotive Works and was a striking success

from the first. Within a very few years it became one of the most popular locomotives all over the world.

### **Company Builds Their Own Locomotives.**

In 1867 the Lehigh Valley Railroad began the practice of building their own locomotives as far as their shop facilities would permit. Engines were built at Delano, Weatherly, Wilkes-Barre, Sayre and at the South Easton shop.

This practice adopted by the company to build their own engines as far as possible furnished abundant opportunity to develop individual ability, a practice that had decided disadvantages. Every division master mechanic became a law unto himself concerning what form of locomotive he should build. The theory was that each master mechanic was the best judge of the kind of engine best adapted for the physical characteristics of that part of the line where he had charge.

The result was great rivalry among the different master mechanics, with train men active partisans ready to abuse or praise the engines, and frequently to put at a disadvantage those they disliked. There were Hoffecker engines, Campbell engines, Mitchell engines, Clark engines, and Kinsey engines, all differing from each other, the motive of difference sometimes being merely dread of imitation.

An undeniable result of the system of making every master mechanic independent of the others was the accumulation of an assortment of patterns such as no other railroad company ever possessed.

There was quite a variety of odd locomotives built by the Lehigh Valley people—some of them marking progress, others marking things and practices that ought to be avoided.

### **Clark's Independent Cut-Off Locomotives.**

Prominent among those oddities were certain locomotives built by David Clark, with a link motion and independent cut-off valve. This gear had six eccentrics, straps and rods, four rock shafts, two reverse levers and rods, two additional valves, valve seats, valve stems and stuffing boxes. The motion is illustrated in Fig. 141. The engines produced what were probably the finest indicator diagrams ever made by a locomotive, but it did not effect any saving of fuel over a common link motion engine of the same class.

In 1871 the Lehigh Valley Company purchased Mason's "Janus" 

(Fig. 91, Page 185), a double-headed engine of the Fairlie type. It did good work as a pusher, and was popular with the engineers, but it never was duplicated.

Alexander Mitchell tried to advance on the consolidation with two engines called the "Ant" and the "Bee" (Fig. 138), which had five pairs of drivers connected and a pony truck in front. The engines gave some trouble on curves, so the back pair of drivers were taken out and a pair of small carrying wheels substituted, making the first of the 2-8-2, or Mikado type. Two engines were built by the Norris Locomotive Works, Lancaster, Pa., in 1867. Quite a number of this kind of engine is now used in mountain service.

#### Searching for the Fittest.

Master Mechanic Philip Hoffecker attempted to improve on Mitchell's 2-10-0 engines by applying a four-wheel truck with all the wheels in front of the cylinders. Some of that class of engines are still in service, but they display no superiority over the consolidation engine, Rogers people built some Moguls with a four-wheel truck in front of the cylinders, but they never achieved popularity. Hoffecker also built 4-8-0 engines afterwards, known as twelve-wheelers (Fig. 139).

#### Strong's Duplex.

In the search for a passenger locomotive which could make time over mountain grades, and also haul a heavy train, the famous "Duplex," No. 444, was developed. This engine was built at Wilkesbarre in 1886. It was the first engine equipped with the Strong twin fire boxes for burning anthracite coal. The boiler was 33 feet long, and was composed of an outer shell in combination with a fire box of two Fox corrugated flues side by side, joining into a combustion chamber. Although the Fox corrugated flue was found very frequently in marine practice, and had been to a limited extent adapted to locomotives in Germany, it has not been a success on American locomotives. The total length of fire box and combustion chamber was 16 feet 4½ inches. The smallest diameter of flue was 38¼ inches. The length of fire box was 8 feet 9 inches.

The engine was a failure, and was a good illustration of what an amateur will do when he undertakes to design a locomotive.

#### Campbell's Audenried.

Another engine with a modification in the link motion was built by Mr. Clark in 1886. This was an eight-wheel engine, the

"Audenried" (Fig. 140), later changed to "John Campbell," intended for passenger service, was a sister engine to that with the independent cut-off built by David Clark, and had his cut-off valve placed above the slide valve. By means of this valve the cut-off could be varied. When it was not in use, the cut-off valve travelled the same path as the main slide valve. This cut-off valve rested on top of the main valve, which had steam passages through it and was operated by an extra eccentric placed on each side of the engine. The motion was transferred to the valve through the medium of a radius bar and slide block. This slide block on radius bar was connected to a lever in the cab by means of a lift shaft and reach rod. Here by means of a notched quadrant, the point of cut-off could be changed at will.

The engine, like Clark's first, was celebrated for the beautiful indicator diagrams it produced, but it did not pull any more cars or burn less fuel than the other engines, so the independent cut-off with its extra attachments was allowed to fall into innocuous desuetude.

Since that time the Lehigh Valley Railroad people have been contented to follow the beaten path in locomotive designing. No better power is to be found in the country, and the company may of late years apply to itself the aphorism "happy is the country that has no history."

Having published the foregoing in *Railway and Locomotive Engineering*, I received the following additional facts from Mr. A. S. Littleton, Cleveland, concerning the

#### Early History of the Lehigh Valley Railroad.

I read with interest the excerpt from "Development of the Locomotive" in your January issue of the most interesting railway paper published. I particularly noticed two things, the first was the omission of "Hazleton" from the list of shops, and later in the article you spoke of the "Audenried, later the John Campbell, having a valve motion like Clark's." Please correct these points. I am glad that I am able to give you the correct version, as well as a complete history of what is now one of the important divisions of the Lehigh Valley, organized and chartered as the Hazleton Railroad.

My informant was the late Ario Pardee, Sr., who organized the company, later leased it and then sold it to the Lehigh Valley. Another authority is a book written by the son of one of the members of the firm of Eastwick & Harrison, one copy of which is

in the library of Swarthmore College. A third was the late David Clark, as well as various engineers of the road before the merger.

### The Hazleton Railroad.

The Hazleton Company was chartered in 1836, built in 1837, and the shops were erected in 1839-40, and the first engine was built there in 1840. It was named the "Lehigh." The company had purchased a locomotive from M. W. Baldwin previously. This was named the "Hazleton," a single pair of drivers and in all respects a Baldwin of that date, except in one important feature, she was a hard coal burner. Mr. Pardee told me that the Hazleton road was the only road that never had a wood burner in service. There was no special arrangement of the boiler. The Lehigh was built on the same plan as the "Hercules" of the Beaver Meadow Railroad, which was the first locomotive to have an equalizer beam. A model of the Hercules was part of the Baltimore & Ohio exhibit at Chicago in 1892 and Mr. Pardee was the first to see the good points of this device (see Harrison's book).

### David Clark Takes Hold.

Mr. Alexander McCausland was the first master mechanic of the Hazleton Railroad until 1840, then a Mr. Merkel, and from 1841 until 1855 Thos. Evans held the position. On September 2, 1855, David Clark was called to the Hazleton Railroad. Mr. Clark found the road equipped with Eastwick and Harrison's four drivers, Hercules type Baldwin single pair, E. L. Miller type, and several six and eight driver Baldwins with the well-known Baldwin truck arrangement, also several engines of the road's own build.

Mr. Clark at once caused predictions of dire disaster by building an engine, the "Superior," with six drivers rigidly fixed and no truck. Every mechanic and engineer held that the Superior would never pass a curve. She did, however. The Superior was a six-wheeler, about 14 or 15 x 22 inches, 44-in. drivers, boiler about 42-in., with swallow-tail fire box similar to Winans, but with fire door at the rear. She burned anthracite coal and was scrapped in 1885 or 1886. The "Oswego," built about the same time, was in service in 1895 at Easton.

Mr. Clark used the same arrangement of rods as Baldwin, that is, main rod to rear driver and all wheels coupled. Encouraged by the success of the Superior, he built engines with eight drivers, rigid base, and in 1867 built engines with 20 x 26 in. cylinders, something rather strenuous in those days.



The Hazleton road was merged with the Lehigh Valley on June 2, 1868, and Mr. Clark then leased the shops until 1871 or 1872, when the Lehigh again took the shops, with Mr. Clark as master mechanic until his retirement in 1892.

### The Audenried.

The device on the Audenried No. 471 (changed to John Campbell because Mr. Campbell had renamed the "Delano" No. 66 the "David Clark") was not only like Clark's, but was Clark's. This device was patented in 1882 by David Clark and Thos. G. Blatch (now general manager Hazleton Iron Works Co.), and was first applied to the W. C. Alderson No. 400. This engine was built to run on the Easton and Amboy Division, Lehigh Valley Railroad and did make several trips in competition with the famous No. 171, Central Railroad of New Jersey, and the engine made as good time as was expected of her. The Alderson was withdrawn from this run because the Easton shops tried to improve the design and she finished her career climbing the mountains of Pennsylvania. Clark's valve motion was applied to the Wm. Brockie, No. 440 and the "Jupiter" No. 120, a ten-wheeler.

Clark built the first Wootten for the Lehigh Valley, the Jno. R. Fanshawe No. 357, which for some reason was rebuilt with fire box on top of frames. This engine for years pulled the fast passenger trains over the Wyoming Division and was one of the main reasons why the Duplex 444 was built—that is "Wilkes-Barre" tried to get something to beat "Hazleton." The Fanshawe was the first of the "Campbell" type; many others were afterward built.

At the time of Mr. Clark's retirement the Lehigh had 659 engines in service. Of this number 450 were built at their own shops (six in number), and of these 130 were Clark's. The eight-wheelers were pulling the fastest passenger trains; the ten-wheelers the fast freights on all divisions, so that you omitted a shop that built 30 per cent. of their engines, while 16 per cent. was the expected quota.

# Demand for Multi-Coupled Engines

## CHAPTER XXI.

### Increasing the Weight and Power of Locomotives.

Ever since the first section of railway was put in operation, there has been a steady movement towards making the locomotive equipment more powerful. The tendency has at times paused for a few years, people claiming that the economical limit of weight and power had been reached, then it would start again and a belief now prevails that the final limit is an engine

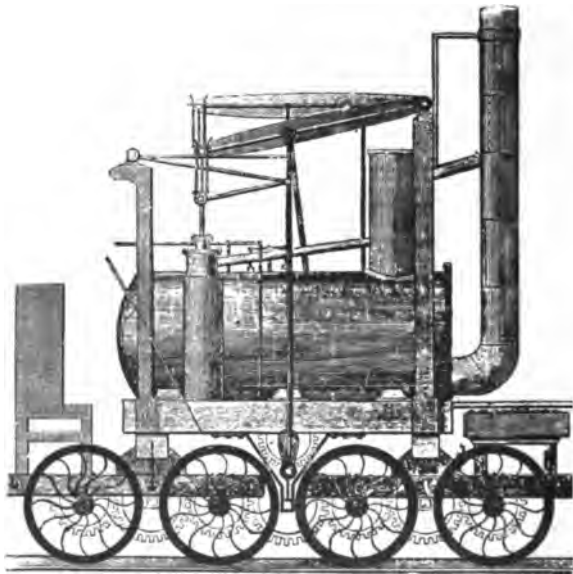

Fig. 143. Puffing Billy, First Eight-Wheel Connected Locomotive

that fits the restricting gauge of bridges and tunnels and cannot be made much larger unless the openings through which it has to pass are made wider and higher.

### Shortcomings of the Iron Rail.

The first restriction encountered to the growth of the locomotive was the comparatively fragile iron rail. The iron rail

wore so rapidly and laminated so badly under heavy or sharp wheel impact, that the prudent railroad manager generally restrained other officials in their zeal to increase the hauling power and, therefore, the weight of locomotives. Motive power officers would argue that they could make heavy engines that would impose no more weight or force of impact upon the rails than lighter ones because more wheels were employed in carrying them; but the permanent way department complained habitually about the destructive effects of heavy locomotives, no matter how many wheels they might have, and the road-master's complaint was listened to more readily than the master mechanic's theories about the action of lightly loaded driving wheels.

### The Inferior Iron Rail.

There were cases where the demands for moving a heavy volume of freight business were so imperative that the rapid wear of rails received little consideration. The coal carrying railroads of Pennsylvania, Maryland, New Jersey and New York, which frequently received more business than their motive power could handle, began about the middle of last century to use engines which were extraordinarily heavy and powerful for that time. The companies using such engines could afford to build and maintain very substantial permanent way and very heavy rails, but this was not the case with ordinary railways.

Until steel rails were introduced the subject of wear of rails was one of extraordinary solicitude to railway managers.

### Introduction of Steel Rails.

Steel rails began to come into use in the United States about 1867 and they very quickly pushed iron rails out of demand. This was not so much that the first steel rails had proved decidedly superior to good iron, but because the makers of iron rails had come habitually to lower the quality of their product. An expert rail maker testified before a committee of the House of Commons, which was investigating complaints about inferior rails being supplied to the railways of India, that the first question asked him by the chief director of a rail making company with which he was negotiating to take the position of superintendent was: "How much slag can you work into a rail?" The slag laden iron rails prepared the way for the rapid introduction of steel when its day arrived.

### **Relative Wear of Iron and Steel Rails.**

Engineers who have made the subject of rail material a special study, say that under the same conditions of road bed and rail section, a good steel rail is about 20 times more durable than a good iron rail of the same section and is less liable to breakage during the whole of its life.

### **Political Effect of Cheap Rails and Heavy Locomotives.**

The invention of cheap methods of making steel rails has exerted a tremendous effect upon railroad transportation, and has created social revolutions in certain parts of the world. It brought the cereals of regions west of the Missouri river, and of the remote Northwest, into competition with the grain raising districts of the Eastern States and with those of Europe and Asia. It threw many farms in New England and along the Atlantic seaboard out of cultivation; it caused a semi-revolution in farming business in the British Isles, and strongly affected the condition and fortunes of millions of people in other countries. Irish peasants used to go in thousands to England and Scotland to work in the harvesting of the grain crops and thereby earned enough money to pay the rent of their small holdings. Steel rails and Consolidation locomotives stopped the cultivation of so many wheat fields in the British Isles, that the help of the Irish worker was no longer needed, and the suffering and discontent arising therefrom led to the vigorous agitation for home rule in Ireland.

### **Trains That Haul Product of a County.**

The woes of Ireland were merely the preliminary manifestations of hardships inflicted through the grim ordeal of competition worked out by our cheapened methods of land transportation. The locomotive, now becoming common, that hauls a train weighing 3,500 tons containing 90,000 bushels of wheat, the product of 3,000 acres, is steadily forcing more grain raising farms of Europe out of cultivation and is raising a demand for protection against cheap land, just as our politicians have so long urged the necessity for protection against the cheap labor of Europe.

The movement inaugurated in 1904 by J. E. Muhlfeld, general superintendent of motive power of the Baltimore & Ohio, in introducing Mallet articulated double-end locomotives, par-

particulars of which are given in Chapter XIII and in following pages, has brought the power possibilities close to the limit unless some new design should be produced. The Erie double-ended locomotive, illustrated on page 197, could haul 16,000 tons on a level at the rate of 10 miles an hour. Under existing form of cars no train of that weight could be kept intact.

Should the policy be adopted of making huge locomotives of the type referred to, the regular freight train motive power, with cars designed to carry immense loads safely, their opera-



J. E. Muhlfeld, Gen. Supt. Motor Power, Baltimore & Ohio, Who Inaugurated the Movement Favoring Double End Locomotives

tion will dry up all the canals in the country and defy all modes of water transportation.

A few days before this chapter goes to the press, E. H. Harriman, the richest railroad magnate the world has ever seen, intimated that he may return to the six-foot track gauge, which he can do, if he is really in earnest, as his financial resources are unparalleled. If Mr. Harriman does this, 200-ton locomotives



First of the American Mallet Double End Compounds, Built for the Baltimore and Ohio Railroad, in 1904, in Schenectady Locomotive Works

will be common and a revolution will be effected in land transportation. Mr. Harriman's scheme has taken away the breath of certain railroad officials, and they are shouting that the thing is impracticable, but nothing of that kind is impracticable to enterprise and unlimited capital.

Speculation is not the part of a historian, but the fact is that railroad companies which have adopted large double-ended 200-ton locomotives have taken the lead into the impracticable. Engines of that weight are too heavy for modern rolling stock and to continue their use will eventually demand a revolution in all track and rolling stock.

About 60 years ago Great Britain abolished all duties on grain, which was the most important action towards free trade. By curious reasoning the statesmen believed that this policy would not only make the British Isles the manufacturers of the world, but that it would increase the prosperity of the agricultural communities as well. The first thirty years' experience of free corn did not seriously challenge the correctness of the free trade theory, for most of the American wheat lands were yet unbroken prairie or virgin forests, and our steel rail makers and locomotive builders were merely getting ready.

In 1850, shortly after the British corn laws were abolished, the leading agricultural States of the Union raised 63½ million bushels of wheat and 281 million bushels of corn, and there were 8,571 miles of railways. In 1870 the principal wheat raising States produced 141 million bushels of wheat, and the leading corn States raised 383½ million bushels of corn. The railroad mileage was 49,168. One decade later the wheat raised in one year was 214½ million bushels and 1,030½ million bushels of corn. The railway mileage had increased to 87,724. In 1899 the wheat produced in the leading States was 234 millions of bushels; the corn amounted to 1,114 millions of bushels.

### Effect of Steel Rails on Freight Rates.

Freight rates have been steadily reduced with the improvements in railroad rolling stock and permanent way. In 1858 the rate per bushel of wheat from Chicago to New York was 38.61 cents. The rate today is 11.4 cents. The distance from Chicago to New York is about one thousand miles. The following table will give an idea of rail rates per 1,000 miles haul, and in March, 1907, it applied to the whole American continent:

**Rates in Cents Per Bushel of Wheat and Corn from Chicago to New York.**

Year.	WHEAT.		CORN.	
	By rail.	By rail and	By rail.	By rail and
		water.		water
Cents.	Cents.	Cents.	Cents.	
1870 .....	26.11	19.58	24.37	19.32
1880 .....	19. 8	15. 8	17.48	14.43
1890 .....	14. 3	8.52	11.36	7.32
1900 .....	10. 8	....	10. 1	....
1904 .....	11.04	....	10. 6	....

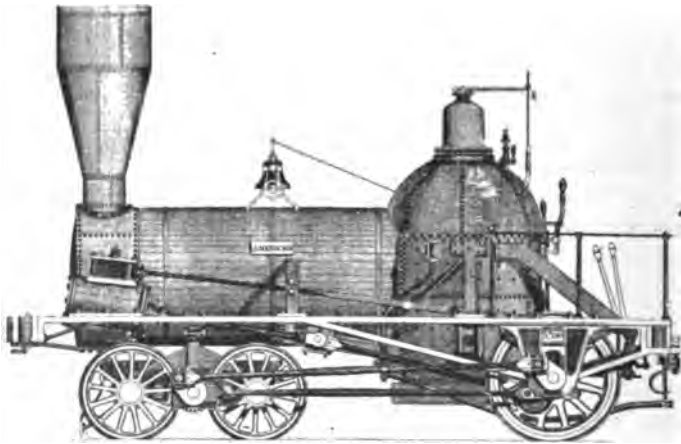

Fig. 144. Baldwin's Attempt to Utilize Truck for Adhesion, 1841

The effect of that cheapening of transportation in the United States has been very disastrous to Great Britain, for during the last thirty years there had been a shrinkage of 3,000,000 acres in wheat and another of 750,000 acres in green crops; an enormous amount of land had reverted to pasturage; the diminution of stock had been 2,000,000 head; the reduction of farming capital had been \$200,000,000; and the number of cultivators of the soil had declined 600,000 in thirty years—1,000,000 in fifty years.

That is a high price to pay for the devotion to a theory which fails to work out as expected.

The cheapening process represented by these figures involved changes that caused terrible affliction and suffering to a multitude of people, but their misfortune has been small compared to



the benefits conferred upon the many by the invention of Bessemer steel and the development of the hundred-ton locomotive.

### Development of the Multi-Coupled Locomotive.

The experiment made by the Camden & Amboy people in 1835 of introducing a very heavy locomotive was an act of progress that happened to be a little premature, but the movement towards heavy locomotives did not lag far behind. The Jarvis truck introduced the six-wheel engine with a four-wheel truck in front and a single pair of drivers behind, a very simple combination which appealed to the taste for simplicity of railway men. It made a very good engine for a light train and a level track,

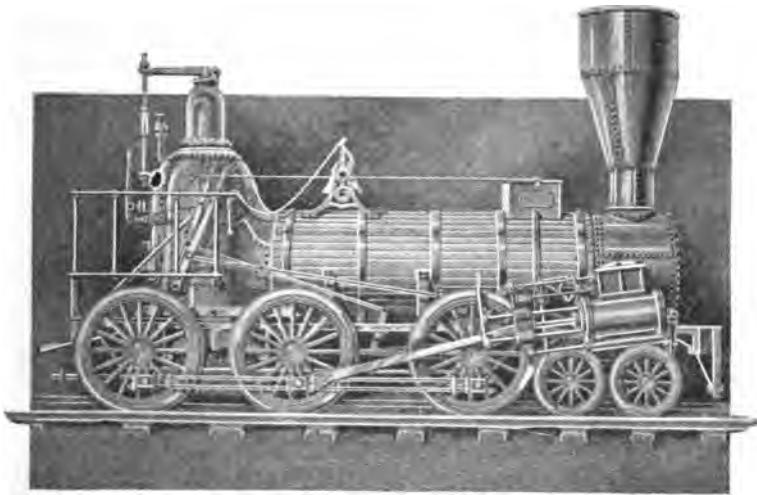

Fig. 145. Norris Ten-Wheeler "Chesapeake"

but increase of business soon demanded something more powerful which brought forth various forms of coupled engines.

### The Campbell Eight-Wheel Engine.

A stride towards increased tractive power was made when Campbell brought out his eight-wheel engine, and that type provided for a good many years of augmentation of capacity before more adhesion wheels were considered necessary except on coal carrying lines. The first American locomotive designer who produced a practical six-coupled engine which perpetuated itself was Septimus Norris, who patented a ten-wheel engine in 1847. This

Norris engine was recognized as the first of a progeny of ten-wheelers that were very fecund and have always stood in high repute with American railroad men in more than deserved repute, for under certain circumstances a ten-wheel engine is given to jumping the track through deficient weight on engine truck.

### Early Six-Coupled Engines.

In giving credit for the advance in locomotive designing produced by Campbell, Winans, Baldwin, Septimus Norris and others, we must not forget that multi-coupled engines were successfully used in other countries long before the time of these inventors. In fact, Trevithicks engine was four-coupled, and William Hedley, finding that his four-coupled engine was hard on the light cast iron

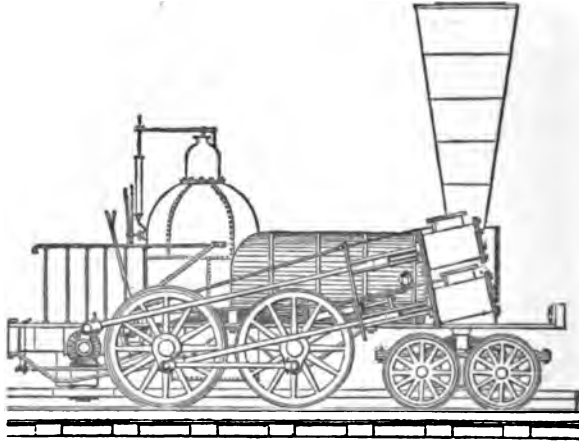

No. 146. Sellers' Hill-Climbing Locomotive

rails, in 1815 put eight wheels under an engine and coupled them by gear wheels (Fig 143). In the same year George Stephenson used a four-coupled engine and tried to secure the adhesion of the tender wheels by means of an endless-chain motion. This was the first attempt to utilize the weight of the tender for increasing the adhesion of the driving wheels, but it was afterwards attempted in a great many different ways. Most of the locomotives employed in operating the Stockton & Darlington Railway, which was opened in 1825, had four-coupled driving wheels, and one six-coupled engine was placed upon the road in 1827. From that time on, six-coupled engines were common in Great Britain, the

principal difference between them and United States multi-coupled locomotives being that the former had no trucks, all the weight being carried on the driving wheels, a practice largely followed by Winan in locomotives he built for the Baltimore & Ohio Railroad.

### Demand for Increased Adhesion.

M. W. Baldwin had been building locomotives only five or six years when he began to be impressed with the necessity for securing greater adhesion to meet the growing demand for more powerful locomotives. In 1839 he purchased for \$9,000 the exclusive right to use E. L. Miller's traction increaser, but that proved only a short lived remedy. He was decidedly opposed at that time to engines with four wheels connected, maintaining that the driving wheels could not be kept of even size and that they would greatly increase the resistance of curves. He also objected to increasing the number of parts.

### Baldwin Builds an Engine Geared With Truck.

Some means of obtaining more adhesion, however, must be devised, and in 1839 he applied for a patent on a geared engine, which was granted the year following. One engine was built in 1841 on this patent, and is illustrated in Fig. 144. The arrangement will be readily understood from the engraving. An independent shaft or axle was placed between the two axles of the truck, and connected by cranks and coupling rods with cranks on the outside of the driving wheels. This shaft had a central cog wheel engaging on each side with intermediate cog wheels, which in turn geared into cog wheels on each truck axle. The intermediate gear wheels had wide teeth, so that the truck could pivot while the main shaft remained parallel with the driving axle.

The engine was unusually heavy for that time, weighing 30,000 pounds. The cylinders were 13x16 inches, and the driving wheels 44 inches diameter. It was sold to the Sugar Loaf Coal Company, and very favorable reports were made of its performance in hauling heavy trains, but it never was duplicated.

In spite of his very positive objections to coupling two or more pairs of wheels by side rods, circumstances pushed Mr. Baldwin far beyond his original judgment on such matters, and in the course of a few years he became the principal builder of multi-coupled locomotives.

### Baldwin Builds Coupled Engines.

The first departure from his conservative practice was carried out at the instance of Ross Winans, who in 1842 induced Mr. Baldwin to build three locomotives for the Western Railroad of Massachusetts. They were delivered in 1843 and are illustrated on page 207. They were the first eight-wheel coupled engines used on this continent.

The die seemed now to be cast for that same year Baldwin built a six-wheel connected engine with the front four wheels forming a flexible truck. These engines gave great satisfaction in train service, the result being that three years later he began building eight-wheel connected engines, the four-wheel flexible truck being in front and one pair of wheels in front of the fire box and another behind.

The six-wheel engine illustrated on page 150 was directly in line of improving on the geared engine since he made the wheels of the truck the same size as the driving wheels, which enabled him to couple all the wheels by side rods, doing away with the extra shafts and cogs that formed part of the geared engine.

### A Mechanical Anomaly.

A flexible truck having wheels coupled to one or more pairs of rigid driving wheels looked like a mechanical anomaly, but that was what Baldwin successfully introduced into locomotive practice. The truck wheels had inside journals, running in boxes held by two wide and deep wrought iron beams, one on each side. These beams were not connected. The pedestals secured in the beams were bored out cylindrically and into them cylindrical boxes were fitted. The engine frame on each side was directly over the truck beam, and a spherical pin running down from the frame bore in a socket in the beam midway between the two axles. Thus each side beam independently could turn horizontally or vertically under the spherical pin, and the cylindrical boxes could also turn in the pedestals. In passing a curve the truck beams acted like a parallel ruler. The side rods were made with cylindrical brasses forming ball and socket joints that enabled them to accommodate themselves to the lateral movement of the wheels.

These locomotives performed an important part in the development of railroad motive power, and then gave place to forms better adapted to the work to be done. An engineer cannot, however, study the details of this construction without being struck with

the wonderful ingenuity displayed in producing smooth-working mechanism under the most serious difficulties.

### Septimus Norris Ten-Wheeler.

As a locomotive with six or more wheels connected without a leading truck was considered unfit for the fragile track of American railroads, Septimus Norris deserves credit for designing the ten-wheeler which was adapted to the existing conditions. The first engine of this type was built in 1847 by Richard Norris & Son for the Philadelphia & Reading Railroad, and was called the "Chesapeake," Fig. 145.

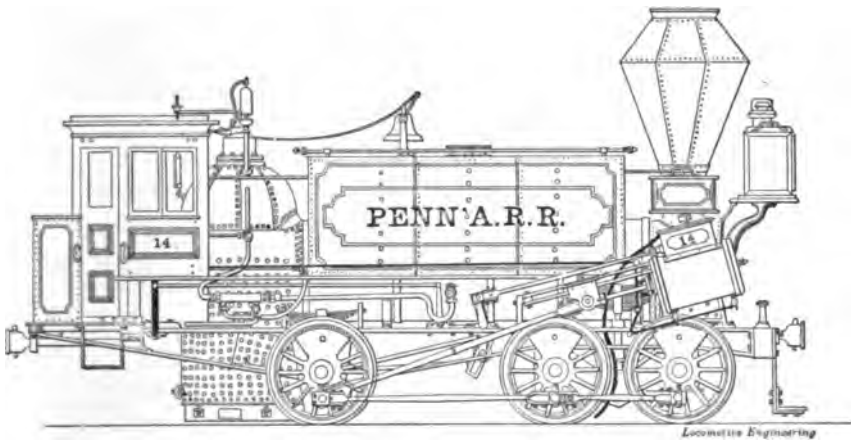

Fig. 147. Early Type of Locomotive Built by Baldwin for Pennsylvania Railroad

The engine weighed in working order 44,000 pounds, had cylinders  $14\frac{1}{2} \times 22$  inches set 75 inches apart, and the driving wheels were 46 inches diameter, axles 5 inches diameter. The boiler was 44 inches diameter, the fire box was  $37\frac{1}{2}$  inches square inside and 50 inches deep. There were 133 2-inch tubes 12 feet long, the total heating surface being about 880 square feet and the grate area about 10 square feet. The duty guaranteed was hauling 890 tons on a level track.

Fears were entertained that this engine would not stay on the track, but no trouble of this kind was experienced. On the contrary, the engines were so successful and popular that the Penn-

sylvania Railroad Company immediately ordered twenty of them, and it exerted a lasting influence on the motive power of that and other railroads.

A student of locomotive designs and development is certain to recognize the harmonious design of the "Chesapeake" when compared with its forerunners and of many locomotives subsequently built. The work of Septimus Norris was of a very durable character, for his example exerted great influence on locomotive building, and there were very few unmechanical looking freight engines built after his time. Nearly all the ten-wheel engines afterwards built by contract shops and railroad companies had a family likeness to Norris's "Chesapeake."

Septimus Norris was a highly cultured mechanical engineer and was author of several technical books that were very popular with the early reading classes of railroad men. He started the Schenectady Locomotive Works, but failing to make the enterprise a financial success, sold out to the interests that made these works so famous.

#### **Hill-Climbing Locomotives.**

About the time that Septimus Norris got out his ten-wheeler an agitation arose among engineers and railway men for some special design of locomotive to be used in hill climbing. As early as 1830, Charles Vignoles, a noted French engineer, who gets the credit in Europe of having designed the T-rail, and Capt. John Ericsson worked for some time together on a plan for a middle rail to be used on steep inclines. They achieved no practical results, but in 1847 George Escol Sellers, who had helped to build some of the first engines used by the Philadelphia & Columbia Railroad, put the idea of a middle rail to practical use by designing a form of locomotive with a pair of wheels on a vertical axis which gripped the middle rail and increased the adhesion. He had four eight-wheel engines built for the Panama Railroad after this design, which is illustrated in Fig. 146. It will be seen that there are two pairs of cylinders, one above the other, the upper one transmitting power through beveled gearing to wheels which gripped the middle rail, the latter being set four inches above the ordinary rails. For some reason the engines were never put into service on the Panama Railroad, probably because it was found that smooth wheels could climb the comparatively light grades of the road. The Sellers' plan was afterwards developed into the rack rail system which is now used so successfully in this country and in Europe.

There were other hill climbers of a different pattern built about this time, one of them having been turned out of the Baldwin Locomotive Works a few years afterwards for the Madison & Indianapolis Railway. It was a true geared railroad engine and is illustrated on page 129, its mode of operation being very apparent from the illustration. These special forms of grade-climbing locomotives were got out to a great extent through a misapprehension of what performances smooth wheel locomotives could achieve in climbing steep inclines.

### Pennsylvania Railroad Winning the West.

The American locomotive has been developed principally through the intelligent enterprise of locomotive builders encouraged by the co-operation of railroad companies. One of the most

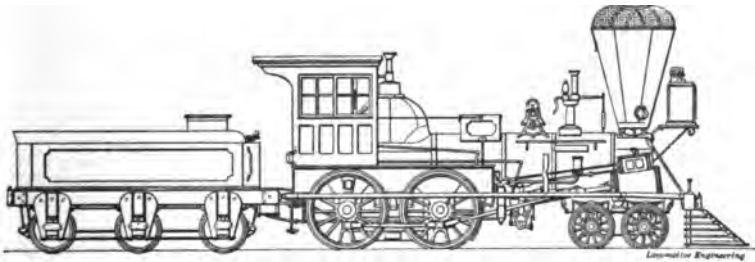

Fig. 147. One of Baldwin's First 4-4-0 for Pennsylvania Railroad

powerful influences in this line of progress has been the Pennsylvania Railroad Company.

I have devoted considerable space to relating facts about locomotive development on the Camden & Amboy and on the Philadelphia & Columbia Railroads, both of which afterwards became part of the great Pennsylvania Railroad system. Now it is time to tell something about the big company which absorbed many others in its process of becoming one of the greatest railroad corporations in the world, with its 5,190 miles of track, 4,023 locomotives and 158,900 cars.

The confluence of the Allegheny and Monongahela Rivers forming the Ohio River formed a trading point that had no equal when the United States was "winning the West." In the days when the trade products of the territories west of the Allegheny Mountains consisted principally of pelts and other products of the hunter's skill, the commercial interests of the Seaboard States did their best to secure the business. It was trading instincts more

than patriotism that sent Braddock to disaster in his expedition to take possession of Fort Duquesne, which then represented the Western interport of trade. In 1758 General Forbes redeemed the loss which Braddock had sustained and took possession of Fort Duquesne, which he called Pittsburgh. As trade developed through the steady increase of population in the forests and prairies of the West, Pittsburgh grew in importance as a distributing point of commodities. With this growth grew the desire of the coast cities to secure as much as possible of the business, the rivalry for this trade extending from Boston to New Orleans.

The Philadelphia & Columbia Railroad, built and operated by the State of Pennsylvania, had made connections with Pittsburgh, but the journey was so broken and tedious that other routes were generally preferred, especially for freight likely to be damaged from repeated handling.

### A Circuitous Journey.

A case of goods sent from Philadelphia to Pittsburgh in 1846 went by rail 81 miles to Columbia, there it was transferred to a canal boat and therein carried 180 miles to Hollidaysburg. Another transfer was then made to what was known as the Alleghany Portage Railroad, a wonderful undertaking in its day, where ten inclined planes and eleven levels took the cars to the Summit Tunnel, 1,339 feet above tide water. The descent from the tunnel to Johnstown was 1,171 feet in a distance of  $26\frac{1}{2}$  miles. On arriving at Johnstown our case of goods is again transferred to a canal boat, in which it goes to Pittsburgh by canal and river.

### Philadelphia Wakened.

Early in the '40's it became apparent to the commercial interests of Philadelphia, that the city was slowly but surely losing its natural share of this growing trade of the West, through the action of the Erie Canal on the one side and of the Baltimore & Ohio Railroad on the other, besides a growing tendency to send freight by New Orleans. The Ohio River had become a more important artery of commerce than ever, since steamboats were carrying settlers into the regions reached by the vast system of water transit connecting with that river. The growing population of the Western territories were raising crops that had to find a market in the populated States on the Atlantic seaboard, or in foreign countries, and they had to receive manufactured articles in return.



As commerce always follows the lines of least resistance, the growing trade of the West was drifting down the Mississippi River to New Orleans or through the lakes to Buffalo to reach New York by the Erie Canal. The Baltimore & Ohio Railroad, in its Westward movement, had reached Cumberland, Maryland, and was striving to obtain from the Pennsylvania legislature the renewal of a lapsed charter to traverse the State to Pittsburgh, where the forks of the Ohio River would put the railroad in touch with the trade of the Ohio and Mississippi Valleys. If that scheme were carried out Baltimore would be the receiving point of the Western trade.

The people of Philadelphia are not easily moved to wrath or readily stirred to violent action, but the prospect of the city being sidetracked off the commerce moving routes was more than the

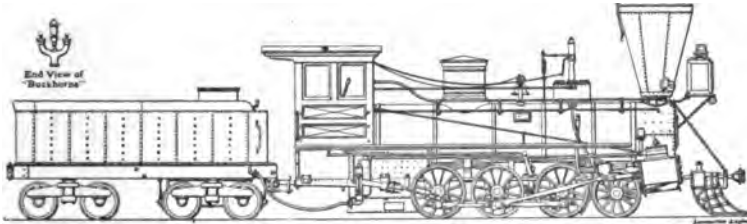

Fig. 148. One of Group of Engines Built by Smith & Perkins in 1852 for Pennsylvania, with Rigid Set Leading Wheels

people would endure. The mills of the gods grind slowly, but they grind exceedingly fine. The resentment of Philadelphia was roused to grind its rivals and the direct effect of it was that the citizens went deep into their pockets to supply the munitions of power for that purpose. A group of the most substantial citizens of Philadelphia organized the Pennsylvania Railroad Company, and in April, 1846, they obtained a provisional charter from the State Legislature, under rather onerous conditions, to construct a railroad from Harrisburg to Pittsburgh.

### Pennsylvania Railroad Chartered.

The charter mentioned stipulated that the stockholders of the Pennsylvania Railroad Company should, on or before July 30 of the following year, pay into the treasury of the company \$1,000,000 on account of stock subscribed, and that one-half of the portion of the road required to be put under contract for construction should be at the western part, beginning at Pittsburgh and extending easterly.

The subscriptions to the stock came in slowly and there was some fear that the required amount of money would not be raised in time, in which event the Baltimore & Ohio Railroad Company would be granted a charter to extend their line through Pennsylvania to Pittsburgh. In this crisis the City Council of Philadelphia came to the rescue and raised the required sum of money. This enabled the Governor to issue the letters patent chartering the Pennsylvania Railroad on February 25, 1847.

### **John Edgar Thomson Appointed Chief Engineer.**

One month later the stockholders elected a board of directors, which lost no time in appointing John Edgar Thomson chief engineer, one of the most important events in the history of the Pennsylvania Railroad Company. Mr. Thomson was from the beginning really general manager. To his supreme engineering ability and to his extraordinary business capacity the Pennsylvania Railroad Company was indebted for its rapid rise to the foremost place among the railroad corporations of this continent.

Tremendous difficulties had to be overcome from the initiation of this enterprise, in order to keep pace with the demands of those who were promoting this new route to the growing West. Surveys of a most difficult character had to be made, contracts had to be let and a department of transportation organized. The company had the opportunity of establishing a carrying business between Philadelphia & Pittsburgh by means of the Philadelphia & Columbia Railroad, with its canal and portage connections westward and the necessary organization for that purpose was established without delay. The Philadelphia & Columbia Railroad, State property, was operated as a public highway, on which any citizen could run vehicles on payment of the legal tolls. The Pennsylvania Railroad made the State road, as it was called, and a connecting road, the Harrisburg & Lancaster Railroad, the eastern links connecting Philadelphia and Harrisburg. The latter town was made the headquarters of the Pennsylvania Railroad and continued to be at that place until the line reached Altoona.

### **Vigorous Railroad Construction.**

The work of construction was pushed with extraordinary vigor. On July 7, 1847, ground was formally broken at Harrisburg, a contract for 15 miles of grading having been awarded some weeks earlier. Work was soon progressing steadily at both ends of the line. The general purpose was to push forward construction of

the Eastern Division, to make early connection with the Portage system at or near Hollidaysburg, which would enable the Pennsylvania Railroad to make rail connection from Philadelphia to Johnstown.

The physical features of the country traversed made railroad construction difficult and in some portions the obstacles to be overcome were stupendous, yet the forward progress of the work was steady as fate. About three years after the first sod was cut at Harrisburg, connection was made with the Allegheny Portage Railroad at Hollidaysburg. That was in September, 1850.

### The Portage Railroad.

The Allegheny Portage Railroad is now merely a reminiscence, with marks of its footprints to be traced in wild woods and moun-



Walter de Sanno, Raised on Philadelphia & Columbia Railroad. Father Was Master Mechanic

tain gorges, where it originally defied the Allegheny Mountains to stand as an insurpassable barrier to stop the western current of civilization. The Allegheny Portage Railroad was the first achievement of carrying a railroad over a chain of mountains, and it was for years visited as one of the wonders of the world. The railroad, with its planes, was thirty-six miles long and reached an altitude of 1,339 feet.

Charles Dickens crossed the Portage Railroad in 1842, and wrote: "It is very pretty, traveling there at a rapid rate along the

heights of the mountain in a keen wind, to look down into the valleys full of light and softness; catching glimpses through the tree tops of scattered cabins, children running to the doors, dogs bursting out to bark, whom we could see without hearing, terrified pigs scampering homeward; families sitting out in their rustic gardens, men in their shirt sleeves working on unfinished homes, and we riding onward high above them like a whirlwind. It was amusing, too, when we had dived and rattled down a steep pass.



Ruins of Old Portage Roadbed

having no other moving power than the weight of the carriages, to see the engine, released long after us, come buzzing down like a great insect, its back of green and gold so shining in the sun that, if it had spread a pair of wings and soared away, no one would have had occasion for the least surprise."

#### No Inclined Planes for Engineer Thomson.

During the various surveys made by the engineers of the Pennsylvania Railroad in search of the easiest route over the mountains, a prevailing belief existed that inclined planes would

have to be used on the steepest portion. A celebrated engineer, Moncure Robinson, demonstrated that the railroad could be carried over the mountains by the aid of one inclined plane; John Edgar Thomson demonstrated that it could be carried over without planes. Mr. Thomson's location was adopted.

### The Pennsylvania Railroad Organization.

In 1852 the Pennsylvania Railroad opened an all-rail line between Philadelphia and Pittsburgh. During the five years the railroad company had been in existence, Chief Engineer Thomson, who had also been made general superintendent, was steadily organizing the operating force, so that by the time the through line was opened the Pennsylvania Railroad organization was becoming celebrated for its efficiency.

When the engineering difficulties surrounding the construction of the railroad were practically overcome in 1852, Mr. Thomson was elected President of the company. Herman J. Lombaert was

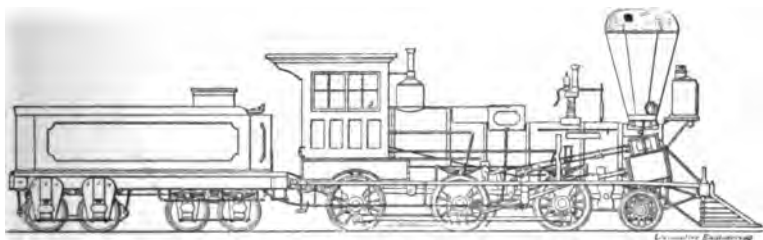

Fig. 149. One of Group of Engines Built by Baldwin for Pennsylvania Railroad 1852 with Rigid Leading Wheels

made superintendent, with four assistants, Enoch Lewis being second assistant, in charge of the Motive Power Department. He was the first of a succession of mechanical superintendents who have displayed eminent engineering ability in improving and developing the railroad rolling stock of the world.

### Enoch Lewis, First Superintendent of Motive Power of Pennsylvania Railroad.

Enoch Lewis was born of Quaker parentage at Wilmington, Delaware, on Dec. 1st, 1821. At the age of fifteen years he began an apprenticeship with Eastwick & Harrison, locomotive builders, of Philadelphia, remaining with them from 1836 to 1842, when he became of age. In 1844 in the employ of Eastwick & Harrison he went to Russia to take charge of a shop at Alexandroffsky,

near St. Petersburg, and superintended the building of cars for the St. Petersburg & Moscow Railway. He remained there two and a half years, returning to the United States in 1846. Between 1846 and 1850 he filled the positions of foreman, first in a general machine shop at Trenton, N. J., and afterwards at Ballardvale, Mass., where he had charge of the manufacture of locomotives and machine tools. In 1850 he entered the service of the Pennsylvania Railroad, taking charge of the round house and repair shop at Mifflin. In 1851 he went into the office of Herman J. Lombaert, then superintendent at Harrisburg, and on Dec. 1st, 1852, was made second assistant superintendent of the Pennsylvania R.R., in charge of the Middle Division, and of the motive power of the road, being located at Altoona.

In 1857 he resigned to enter the employ of A. Whitney & Sons, car wheel manufacturers, remaining with them two and a half years. He returned to the Pennsylvania Railroad in April, 1860, as general superintendent, holding that position throughout the War of the Rebellion, and resigning December 31st, 1865.

On May 1st, 1866, the position of purchasing agent of the Pennsylvania Railroad was created and given to Mr. Lewis. This position he held until December 1st, 1893, when he resigned it because of advancing years. He died on November 15th, 1902.

By this time the motive power department had become very important, as the company had been purchasing locomotives ever since it was organized, and a great many new ones were ordered to handle the great increase of traffic incident to the opening of the line through to Pittsburgh.

### Receiving Locomotives.

The Baldwin Locomotive Works supplied the Pennsylvania Railroad with the first locomotives used. They were the standard engines that the works were turning out. In 1849 three engines of the type shown in Fig. 148 were bought from Baldwin's. They were called the "Mifflin," "Blair," and "Indiana." The general dimensions were cylinders 14x20 inches, driving wheels 72 inches diameter, weight 47,000 pounds. These were high speed passenger engines and were not kept long in service before their performances suggested the changing of new engines to other forms.

### President Thomson's Selection of Locomotives.

President Thomson had ideas of his own concerning the kind of locomotives best adapted for working the trains over the numer-

ous grades of the road, so he contracted for certain engines from Baldwin's and from Smith & Perkins that were delivered in 1852. The Baldwin engines are illustrated in Fig. 149; the Smith & Perkins in Fig. 148. The approximation of a certain weight was specified and the builders were given the option of putting a two-wheel or a four-wheel truck in front. A few of each make had two wheels leading, but most of them of that kind were changed because there was too much weight resting upon a single axle.

The engines built by Smith & Perkins were of the same form as Millholland's Pawnee class built the same years as the first of this Smith & Perkins group. They were six-wheel connected engines with a pair of carrying wheels behind the cylinders. It was



Fig. 150. "Wilmarth," Built 1852 for Pennsylvania Railroad

becoming apparent that small wheels in front of the drivers were necessary to prevent flange cutting on crooked roads, and the wheel arrangement shown was part of the experiments that led to the Mogul.

The cylinders of these engines were 17x22 inches and the driving wheels were 44 inches diameter. The weight of the engine was 54,000 pounds. The valves, which were plain slides without a cut-off, were driven by drop hooks. The boiler, as may be noted, was straight, but two of the group had wagon top boilers, then in an experimental stage.

### The Rotten State Road.

The State Railroad was managed by the politicians of Pennsylvania, and its operation became a fearful example of how deeply corruption could sink into men who were accountable

to no person out of their own clique. The only test of efficiency among the men carrying on the operation of the railroad was loyalty to the politicians. While the railroad was doing a good business, for which an excellent revenue was received, State officials permitted so many friends to secure the transportation of persons and freight free of charge that the losses increased the State debt so steadily that bankruptcy was becoming imminent to the people of Pennsylvania. Then the conscience of the people was roused, and they rose *en masse* and elected a legislature which sold the railroad to a private corporation at more than its value, but at about one-fourth of the amount of public money expended upon the Philadelphia & Columbia Railroad.



Fig. 151. Old Northumberland Baldwin, 1853

### Pennsylvania Railroad Buys the State Road.

In December, 1855, President Thomson, acting for the stockholders of the Pennsylvania Railroad Company, offered \$7,500,000 for the main line from Philadelphia to the Monongahela and Allegheny Rivers, including all the equipment and real estate.

The offer was not accepted, but on June 25, 1857, the whole of the property was sold at auction to the Pennsylvania Railroad Company for the sum previously offered. On the first of August following the Pennsylvania Railroad Company took possession of the property, including the Philadelphia & Columbia Railroad, and the reign of politicians as railroad officials terminated.

The first through train between Harrisburg and Philadelphia made its trip on the day the sale referred to was effected. The



train was hauled by the "Butter," a Baldwin engine built for the State road. The Harrisburg & Lancaster Railroad was used by the Pennsylvania Railroad to make this through connection and it was shortly afterwards absorbed by the greater company.

### Reliable Baldwin Records.

It is now impossible to obtain particulars concerning the pioneer locomotives supplied to the Pennsylvania Railroad, except those built by the Baldwin Locomotive Works, where records are still preserved and are readily given out to investigators. From that source I have learned that in 1847 they built two locomotives called the "Dauphin" and the "Perry" for the Pennsylvania Rail-



Fig. 152. Baldwin, 1854. Never Changed. Old Number 106

road Company. These were the regular eight-wheel, coupled with flexible beam truck. The next engine, delivered in 1849, was named the "Mifflin," of the type shown in Fig. 147, already described.

Between the time these engines were finished and 1852 four four-wheel connected engines with four-wheel trucks were delivered. These were in 1849 the "Juniata" and the "Huntington," with cylinders 14x20 inches and drivers 54 inches diameter. In 1850 were delivered "Allegheny" and "Clarion," with cylinders 14½x20 inches, drivers 54 inches diameter; "Clinton," "Columbia," "Elk," "Erie," "Venango" and "Centre," with cylinders 15x20 inches and 54-inch drivers; "Wyoming" and "Armstrong," cylinders 13½x22 inches and driving wheels 60 inches diameter.

In 1851: "Clearfield," "Crawford" and "Bradford," with cylin-

ders 15x20 inches and 54-inch drivers. In 1852: "Butler" and "Susquehanna," with cylinders 13½x22 inches, with 60-inch drivers; "Fayette" and "Green," with cylinders 15x20 inches, with 54-inch drivers; "Somerset," "Pike" and "Union," with cylinders 15x20 inches and 60-inch drivers.

Two eight-coupled engines with the Baldwin flexible beam truck were built in 1850. One, the "Westmoreland," had cylinders 17x22 inches, with 43-inch drivers; the other, the "Beaver," had cylinders 14½x18 inches, with 42-inch drivers.

Six ten-wheel engines were built in 1852 for the Pennsylvania Railroad named "Bradford," "Dauphin," "Lawrence," "Mercer," "Lebanon" and "Berks." These had cylinders 18x22 inches, with 44-inch drivers, with chilled tires, and weighed about 56,000 pounds. They were equipped with eight-wheeled tenders, having



Fig. 153. Baldwin, Built 1854

a tank capacity of 1,800 gallons. These engines were originally covered in an order of twelve eight-wheel six-coupled engines, the leading wheels and axles of which were held rigidly in pedestals on the main engine frames.

The six engines mentioned were altered before leaving the locomotive works, and a four-wheeled center bearing truck was substituted for the single pair of leading wheels. The same type of engine built by Smith & Perkins (Fig. 150) had the small pair of wheels behind the cylinders removed and a four-wheel truck put under the smoke box.

As to four-coupled eight-wheel engines of the 4-4-0 type built in 1854, we find the following: "Montgomery," "Montour," "Monroe," "Northampton," "Perry," "Potter" and "Sullivan," with

cylinders 17x20 inches and 54-inch drivers; "Blazing Star," "Chamois," "Gazelle," "West Wind," with cylinders 16x22 inches and 66-inch drivers; "Belle" and "Flirt," with 16x22-inch cylinders and 72-inch drivers.

This is as far as it is necessary to dilate upon the pioneer locomotives supplied to the Pennsylvania Railroad, since it shows clearly the trend of locomotive growth. By that time this railroad had adopted the forms they adhered to for many years. That was the 4-4-0 type for passenger service and 4-6-0 or 2-6-0 and 2-8-0 for freight.

### Pennsylvania Railroad Early Locomotives.

In December, 1857, the Pennsylvania Railroad owned 211 locomotives in serviceable condition. Of these 70 had been bought



Fig. 154. Winans' Camel, Built 1856, Rebuilt 1863

along with the State Railroad. Of the remaining 171 bought originally for the Pennsylvania Railroad, there were:

Baldwin. . . . .	85
Norris. . . . .	27
Winans. . . . .	11
Wilmarth. . . . .	3
Smith & Perkins. . . . .	15
	—

141

The history of the development of the locomotive on the Pennsylvania Railroad may be graphically followed up to 1870 by the

illustrations of this chapter beginning with Figure 147. Every succeeding form shows signs of progress which has been steadily followed up to the present day.

### Abolishing Names of Locomotives.

All these engines had names, but a system of numbering was adopted in 1857, the names being removed as fast as practicable. The year 1857 distinctly marked a new era in the locomotive practice of the company. All new engines above No. 211, especially for freight service, differed decidedly from those formerly used. They all had the cylinders set horizontally, or nearly so, link motion was applied without separate cut-off valves, injectors were supplied and casings were put over cylinders and steam chests.



Fig. 155. Lancaster, 1857

Six-wheel connected freight engines had the front driving wheels well forward, and the second and third pairs of wheels well apart to make room for a long fire box, as in Figs. 151 and 157. All the four-wheel trucks were spread to make room for the cylinders, outside frames were abandoned. Red and green paint had embellished the old engines giving the butterfly appearance that Charles Dickens noted on the Portage Railroad engines. That was given up for the sombre green and black. The Pennsylvania Railroad engines were given the lead in working towards modern appearance.

### Improving the Pony Truck.

In 1861, when John P. Laird became superintendent of motive power, he soon began experimenting with a two-wheel truck for

the purpose of preventing the driving wheel flanges from cutting, which they did very freely on the numerous curves. The first pony truck, from the point of view of to-day, was very crude and was not even provided with springs. The axle was made with large collars shrunk on inside of the journals. In a projection on top of the journal boxes was formed a sponge box filled with waste, and it was bolted to two rectangular horizontal equalizer bars, extending to the rear far enough to have the rear end attached to the front hanger of the front driving spring, the rear end of which was hung from the main frame in the usual manner. To the equalizer bar on each end of the locomotive was attached a fulcrum shoe, flat on top, bearing against a plate fastened to the inside of the main frame, with lips in front and rear to limit the



Fig. 156. New Jersey Locomotive & Machine Co., 1867

fore and aft movement of the equalizer, and used as a substitute for the center pin of to-day. Most of the pony trucks were at first applied to eight-wheel connected engines, the first pair of drivers being removed to make room for the truck.

Mr. Laird simplified that arrangement later by adopting the Bissell truck. All six-wheel coupled engines were at first equipped with four bar guides, an awkward arrangement which Mr. Laird obviated by applying the peculiar double bar guide and cross-head which bear his name.

### The Motive Power Department.

The motive power department of the Pennsylvania Railroad has never been noted for the adoption of revolutionary changes.

They have always proved that which was good before adopting new forms or new attachments, but they have always been ready to try things that promised to be improvements. When steel rails began to come into use, about 1867, the Pennsylvania Railroad were among the first lines to adopt the more durable material, and they proceeded steadily to increase the weight of their rolling stock, justified by the improved conditions of track. No railroad officials were more active than those at Altoona in trying stronger material for motive power, as it was offered for use. Steel fire boxes, steel tires, steel boilers, steel wheel centers and steel frames were hastened into popularity by the influence of the Pennsylvania Railroad Company.



Fig. 157. Baldwin, 1857

### Theodore N. Ely.

In acknowledging this progressive policy, it is fair to give due credit to Theodore N. Ely, chief of motive power, whose progressive influence has done so much to make the practice of his department a safe guide for others to follow. Mr. Ely entered the engineer's department of one of the Western lines of the Pennsylvania Railroad in 1868. He has been in turn engineer, superintendent, superintendent of motive power, general superintendent of motive power, and now chief of motive power, in every position, performing his duties with credit to himself and profit to the Pennsylvania Railroad Company.

### Pennsylvania Railroad Organization.

The Pennsylvania Railroad Company have always been celebrated for their fine organization, which defines the duties and responsibilities of every department and section.

It was inaugurated by President J. Edgar Thomson and has grown steadily to keep pace with the increase of the company's business. The plan of organization as now printed resembles a reversed genealogical chart with the stockholders on the top, followed by the Board of Directors and President. Beneath come the various Vice-Presidents, with lines leading to the officials of the various departments.

Take the First Vice-President, for instance. His "lines of



Theodore N. Ely, Chief of Motive Power, Pennsylvania Railroad

force" run direct to the Comptroller, Assistant Comptroller, as all officers are naturally subservient to the head of this department. The General Manager seems to receive information direct from the Second Vice-President, and his direction goes direct to the General Superintendent, who in turn directs official subordinates to them. On the other branch the General Manager deals directly with the General Superintendent of Motive Power, who controls the mechanical engineer, engineer, the engineer of tests, the chemist, etc.

To portray all the ramifications of this elaborate system of railroad management would take more space than I can afford to give it, and moreover the details are hard to understand without a diagram. Suffice it to say that the system is as nearly perfection as such a thing can be made and that it has produced the most harmonious relations throughout the whole service of any plan of railroad management ever introduced. There is no railroad in the world where the esprit de corps is better than it is on the Pennsylvania Railroad system.



Fig. 158. Pennsylvania Railroad, Built 1870



# Railroads Westward Ho!

## CHAPTER XXII.

### Little Locomotive Building in the West.

In writing a history of the Development of the Locomotive Engine, it has been impracticable to expatiate to any extent on railroad history beyond the influence which certain railroads exercised on the development of the motive power. In this respect the railroads west of the Allegheny Mountains took little part. They purchased their locomotives from Eastern makers and were satisfied with the progress made as manifested by the work of contract builders.

Several attempts were made to establish locomotive building works west of the mountains, but none of them met with permanent success except the Pittsburgh Locomotive Works, of Pittsburgh, Pa., the Porter Locomotive Works, Pittsburgh, and the Brooks Locomotive Works, Dunkirk, N. Y.

### Alluring Strangers to Our Gates.

Enjoying the use of railroads to a limited extent for twenty-years exercised a most stimulating effect upon the prosperity of the country. A fair gauge of the progress of the United States or of any sparsely settled country is the number of immigrants arriving annually to devote their labor to the development of the country.

During the decade from 1821 to 1830, 143,439 immigrants landed in this country. This incoming flow of strangers increased with the activity of railroad construction, until in the ten years from 1841 to 1850, the number of immigrants was 1,713,251. The railroad enterprises were so numerous that this vast mass of newcomers readily found employment where they could establish comfortable homes.

After railway construction began, a part of the westward movement of population was surging in advance of railroad building, the enterprising people being contented to go forward and wait for the railroads that would give them easy communication with the commercial world by the time they had produce to sell

and were ready to purchase the commodities that the outer world would supply. They went by rail, by boats on lakes and other waterways, and then by prairie schooner found their way to the more fertile regions open for settlement.

It was not safe, however, to settle far from a point of shipment by rail or water, because produce could be carried by wagons but a short distance before the cost of transportation would equal the value of the load.

### **Westward Ho!**

During the decade from 1851 to 1860 there was a strong tide of population moving to fill vacant spaces in the West, and railroad construction became active in regions where ten years earlier the sound of a steam whistle or safety valve roaring the song of industrial activity had never been heard, and as a result locomotive building tended to follow the flag.

The railroad builders during the genesis of Western railroads encouraged people to engage in locomotive building, with the idea that they might have to depend upon local manufacturers for supplying their motive power. Under this sentiment concerns in Cleveland, Cincinnati, Dayton, Covington, Detroit, Chicago, St. Louis, Louisville and many other places began to build locomotives much to their subsequent sorrow.

Among these were Cuyahoga Steam Furnace Co., Cleveland, Ohio; H. & F. Blandy, Zanesville, Ohio; C. Cooper & Co., Mount Vernon, Ohio; Niles & Co., Cincinnati, Ohio; Moore, Richardson & Co., Cincinnati, Ohio; A. L. Greer & Co., Covington, Ky.; Kentucky Locomotive Works, Louisville, Ky.; H. H. Scoville & Son, Chicago, Ill.; Menominee Locomotive Works, Milwaukee, Wis.; Palm & Robertson, St. Louis, Mo.; De Graffe & Kendrick, Detroit, Mich., and E. Thrasher & Co., Dayton, Ohio.

### **The Cuyahoga Works.**

The most famous of the defunct Western locomotive works was the Cuyahoga Works, at Cleveland, O. They were general machine shops doing all sorts of engineering jobbing, mostly the repairing of steamboat machinery. The works began building locomotives about 1850, Elisha Sterling being manager and Ethan Rogers superintendent. When they decided to build locomotives T. L. Simpson, a master mechanic on the Michigan Central Railroad, was engaged to supervise the locomotive depart-

ment. Simpson must have been a good designer for they turned out locomotives that were famous wherever they were known. The desire for high speed locomotives was then in vogue and the Cuyahoga Works built some eight-wheel engines, with drivers 6 feet diameter. The Cuyahoga cut-off was also famous and I have frequently been requested to illustrate it in the articles that have formed the basis of this book. It appears in the Chapter on Valve Motion.

I am tempted to repeat a story told in "Locomotive Engineering" years ago by F. J. Holloway, a famous engineer, who was one of the originators of the American Society of Mechanical Engineers. Mr. Holloway was a graduate of the Cuyahoga shops and felt much personal pride in the locomotives built there. He wrote:



Fig. 159

### The "Louisville."

To those whose memories stretch back more than half a century, the sight of the Louisville (Fig. 159) will excite into view scenes long passed away. This engine was one of the famous Cuyahoga productions, built for what was fondly called the three C's—that was the Cleveland, Columbus and Cincinnati.

A few changes had been made upon the engine before this photograph was taken. Originally the steam chest had been inside the smoke box where it suffered from overheating and was difficult to reach for valve facing. The running board was originally carried straight from the cab to smoke box, an awkwardly connected link motion had been applied in place of the old V-hook motion, but the cut-off had been retained at the sword-arm for regulating the travel, is very conspicuous.

### Victory of a Cuyahoga Locomotive.

There were good talkers among the engineers of those days, who were not afraid to express in language, often more expressive than polite, what they thought in favor of their own engines or in disparagement of others, and many a summer day was made warmer as a group of engineers on the shady side of the round-house whittled, bragged and bantered each other. Once, after an unusually warm debate over the performance of a newly-arrived Eastern engine, as compared with a pet engine built at the "old Cuyahoga," it was decided to have a trial of the two engines in order to settle the matter.

The consent of the master mechanic having been obtained, a trial was arranged which in every respect differed from the trial trips as now made. What they wanted to know was which of the two engines, having the same quantity of wood and water, could go farther on the same day, and over the same track. So it was arranged that the "Cuyahoga" engine and the Eastern should both start on an equal footing from Columbus, and run as far as they could towards Cleveland without replenishing fuel or water. It may well be understood that each engine was put in the best possible trim, and each engineer and fireman was at his best. Along the line at every town were gathered the railroad men, from the wood sawyer to the station agent, to greet and cheer their favorites as they sped along northward, until, at last, the Eastern engine struck the descending grade several miles outside Cleveland, and by its aid it managed to crawl into the depot bereft of wood, water and steam. Then the query was, where was the Cuyahoga engine, of which so much was expected? Had it gone dead and cold somewhere back in the woods, and would another engine have to be sent out to drag it in, lifeless and disgraced?

For a while it looked blue for the Cleveland boys, but not long, for soon their pet engine was seen bowling down the grade, and as it neared the depot the crowd parted to clear the track, when the engineer motioned to open the switch leading to the Lake Shore track. Then with a defiant blast of victory, it dashed on towards Buffalo and never stopped until it reached Painesville, thirty miles away. The test was considered complete in favor of the backwood built engine.

### Niles Locomotive Works.

At that time two locomotive works were in operation in Cin-

cinnati, the principal one being the Niles Locomotive Works, of which the venerable Dr. Coleman Sellers writes me:

“The Niles company consisted of two men, Jonathan, the eldest, and James, and they were the only members of the firm. For many years beginning at 1846, I was intimate with these gentlemen, and in my superintendence of the Globe Rolling Mill I bought machinery of them at which time they were engaged principally in sugar mill work, machine tools and shafting and steam engines generally. In 1851 they decided to start an establishment for building locomotives, there being but one other builder of locomotives in Cincinnati at that time. During '49 '50 and '51, when I had to do with the building of locomotives which were designed by my brother George Escal Sellers for



Early Niles Locomotive

the Panama Railroad and intended for hill-climbing, Mr. Jonathan Niles consulted me about his locomotive works, and in the beginning of 1852 I was employed by him to arrange the accounts of the establishment; but very soon thereafter I took charge of the works as foreman and continued with him until the end of '56.

“The first engines built by Niles were designed by a Mr. Mann, but there was nothing remarkable about them. It was not until the Niles firm secured the services of Mr. John L. Whetstone, who was with me in the Panama engine building, that any important improvements were introduced and experimentally a few engines were built with plate frames, but abandoned for the bar construction. The chief work which Whetstone did was to perfect the link motion and by careful and well made drawings and systematic attention to the work, a great deal of the “cut and try” methods of setting the valve motion of these engines were

done away with, and the engine went out with what would not be considered extraordinary at the present time, but was remarkable at that time, namely, that the action was absolutely uniform in the forward and back motion of the link.

"We also at that time built two engines for a road in Pennsylvania. These were built of the hill-climbing type, but never used in that way. We also continued the single and eccentric valve motion, the lead being obtained from the cross-head. This I think was described by Whetstone at my instance in a paper read before the Franklin Institute. It was a type of radial motion afterwards made popular by Walschaerts.

"The Niles engine did good work on the Western roads and they had a succession of orders which kept the establishment full until I left them and joined with the firm of William Sellers & Company at the end of 1856. It was not many years after this, that the Niles retired from business and moved to Hartford, Conn., where they resided until they died."

### Chicago Appears.

As early as the decade 1831 to 1840 a small stream of people looking for a new location was flowing into Northern Indiana and Illinois. These people were the select of the human tide moving towards the setting sun, for only the most hardy, the bravest and the most vigorous will venture into regions where danger is ever present and comfort always absent.

These people began to drift into a small hamlet at the mouth of the Chicago River, and the first footing of the town of Chicago was established, not by the lawless, the idle and the reckless men we have so often found to be parasites on pioneer towns, but the bravest, most industrious and most enterprising of their kind brought together by the law of natural selection.

### The Locomotive "Pioneer."

The first locomotive to raise noise echoes in Chicago was the "Pioneer," whose antique appearance is familiar to people who visit the Field Museum in Chicago. The engine is well worthy of careful examination by people who appreciate the great benefits conferred upon humanity by the locomotive engine.

After tedious research I have succeeded in tracing the history of this old locomotive, which is an object of keen interest to many people, especially those about Chicago. The "Pioneer" was



Tablet Placed on C. & N.-W. Ry. Station, Wells and Kinzie Streets,  
Chicago

By courtesy of "Railway Age"

the thirty-seventh locomotive built by M. W. Baldwin, and was turned out in 1836 for the Utica & Schenectady Railroad. After a few years of service in the Mohawk Valley, the engine was sold to the Michigan Central Railroad where it was known as the "Alert." While in Michigan a few changes were made on the engine. As originally built it had a single fixed eccentric for each cylinder with two arms extending backwards having drop hooks to engage with a pin on a rocker arm which actuated the valve rod. That motion was removed and double eccentrics with V-hook put in its place, the motion now found on the engine.

When the Galena & Chicago Union Railroad Company were



Marvin Hughitt, President Chicago & North-western Railway, who saved "Pioneer" from destruction

ready to begin tracklaying in 1848 they bought the Alert from its owners and called it the Pioneer, a proper name for the first locomotive to perform service west of the lakes.

The Pioneer is the same type as Baldwin's second engine the Miller, described on page 60, long a favorite pattern with Mr. Baldwin, but is larger and has two inches longer stroke, but the other details are the same except the improved valve motion.



### The Pioneer Tries a Feed Water Heater.

Extract from a letter written by Richard W. Bushnell, for many years master mechanic of the Burlington, Cedar Rapids & Northern Railway, giving reminiscences of the Pioneer, will add interest to the engine:

"I had been working in the machine shop in 1855, ambitious to run an engine. John Ebbert, the master mechanic, said that I could have the Pioneer and I was delighted. She was then in the shop under repairs and a feed water heater, patented by Peter Ebbert, was being applied.

"The heater consisted of vertical pipes placed around the inner side of the inside pipe of the smoke stack and connected at top and bottom by return bends, the pump forcing the water through these pipes to the boiler.

"The stack was of the ordinary pattern for wood burners in those days, but to get ample surface for the water heater, the inside pipe was made very large to get as many pipes in as possible. To cap this and to retain heat in the stack the cone was made unusually large.

"When the engine was ready Mr. Ebbert, round-house foreman, the patentee of the heater, was to run the engine on the first trip while I was installed as fireman. The incidents of the trip from Chicago to Sterling, 110 miles, would fill a book. I paid for lodgings at two stopping places. The trouble was want of steam. We would run four or five miles then the engine would stop and remain raising steam. The longest night has an end and the worst steaming engine will get there with time and patience. When we reached Sterling Peter Ebbert jumped off the engine and informed Burgess, the foreman, that we had had a splendid run but he could not wait to take the engine back to Chicago and recommended Burgess to take the pleasure trip with the Pioneer. Burgess was willing, but first he removed the cone and cut it down to about the size of a small wash basin.

"With that change the trip had its difficulties. There was a story current among the train men that, being unable to get over one of the hills, Burgess went to a farmer who was plowing and hired him to bring his yoke of oxen to help the engine over."

Mr. Bushnell did not say what became of the feed water heater, but was probably removed after proving a failure, for Mr. Bushnell pulled the pay car with the engine for several years. He had many close escapes from head collisions but no serious

damage was ever sustained and the engine passed through all perils to reach the glorious haven of a museum at last.

### Chicago and Northwestern Railway.

The management of the Chicago & Northwestern Railway, and particularly Marvin Hughitt, the president, deserve much credit for their good sense in preserving this old engine for years and then bestowing it upon a museum where it will be an educational lesson to generations of unborn seekers after knowledge.

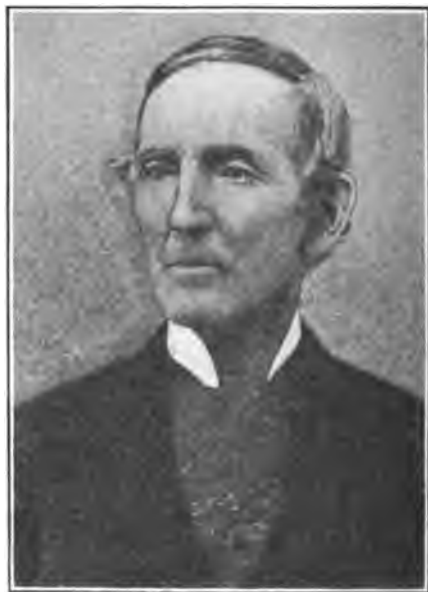

John Ebbert, First Engineer of "Pioneer,"  
First Master Mechanic of Chicago  
& Northwestern Railway

As a class railroad managers in this country displayed sad lack of sentiment toward articles possessing historical value. Utilitarianism was so rampant among the early managers that the scrap heap swallowed thousands of things that would now form valuable educational mediums. Those were the kind of men who would readily melt the Liberty Bell for the metal it contains. European railway managers displayed much more liberality and far-sightedness which kept from destruction such relics as Hedley's Puffing, Billy Stephenson's Rocket, and hundreds of other articles which are preserved in museums.

By his sensible act in saving the Pioneer Mr. Hughitt introduced a new fashion which is still popular and has saved many interesting articles to a better fate than the melting pot.

The company which brought it to Chicago also deserve particular mention. In 1836, when there was not a mile of railroad west of the Ohio River, some enterprising citizens of the small village of Chicago were agitating the project of connecting Chicago and the Mississippi River by means of a railroad. The result of their zealous labors was a special charter granted by the State Legislature for the Galena & Chicago Union Railroad, authority being given to build a railroad into the prairie country on towards, if not to, the Mississippi River, near the lead mines at Galena, Ill.

### Salt of the Earth Seasons Chicago.

The spirit that brought forth that charter at a time when the far spreading prairie land of Illinois was mostly a possibility was the dauntless spirit which raised the population of Chicago from 4,170 in 1837 to 1,698,575 in 1900. The energy and sturdy ambition displayed in securing the charter were not however equal for several years to perform the task of building the railroad. The potentialities of wealth, and the building of a city that might some day rival lordly Boston, were in the eyes of the promoters; but their purses were light and their commercial operations were principally confined to trading on a small scale by barter.

The scheme had been under agitation, carried on vigorously enough for fourteen years, when, in 1847, what might be termed the first overt act happened by the beginners of a location survey. The chief engineer of this operation was Richard P. Morgan, whose services were considered worth \$2.50 a day. In 1848 dirt began to fly, as Westerners say, the Pioneer locomotive appeared upon the scene and rails of strap iron began to creep westward towards the Mississippi and the limitless territory beyond. It was a stupendous event, whose effects are not properly realized, or it would be the subject of epics in ink and marble.

The rapid progress of the railroad in that thinly settled region may be judged by the increase of locomotives, for no enterprise of that character is worth anything without the motive power plying its vocation through increasing numbers and size of engines.

From "A History of the Chicago & Northwestern Railway System," compiled by W. H. Stennett, I reproduce the following table:

## Locomotives Belonging to the Galena & Chicago Union Railroad.

Name of Engine.	Name of Maker.	Put in Service	Weight in Tons.
Pioneer.....	Baldwin, Philadelphia, rebuilt.....	October 24, 1848	10
Chicago.....	Norris & Bros., Philadelphia, rebuilt.....	July 17, 1849	24
Elgin.....	Norris & Bros., Philadelphia, rebuilt.....	November 6, 1849	24
Illinois.....	Norris & Bros., Philadelphia, rebuilt.....	October 17, 1851	24
Belvidere.....	Norris & Bros., Philadelphia.....	November 6, 1851	24
Rockford.....	Norris & Bros., Philadelphia.....	November 2, 1851	24
J. B. Turner.....	Rebuilt from Whittlesey, by Galena & Chicago Union Railroad.....	January 1853	12
Marengo.....	Schenectady Locomotive Works.....	August 11, 1852	12
Minnesota.....	Norris & Bros.....	September 19, 1852	24
Iowa.....	Norris & Bros.....	September 21, 1852	24
Kishwaukie.....	Norris & Bros.....	September 27, 1852	14
Shawboney.....	Schenectady Locomotive Works.....	October 29, 1852	24
Waubensee.....	Norris & Bros.....	November 15, 1852	25
Winnebago.....	Exchanged with Chicago & Aurora Railroad for Whittlesey.....		
Ariel.....	Lowell Machine Shop.....	June 27, 1853	20
Cloud.....	Lowell Machine Shop.....	June 28, 1853	20
Du Page.....	Rogers, Ketchum & Grosvenor, Paterson.....	July 29, 1853	20
W'g Thunder.....	Rogers, Ketchum & Grosvenor, Paterson.....	August 18, 1853	23
De Kalb.....	Schenectady Locomotive Works.....	August 25, 1853	25
Des Plaines.....	Schenectady Locomotive Works.....	September 13, 1853	25
Kehotaw.....	Schenectady Locomotive Works.....	September 24, 1853	25
Enterprise.....	Chicago Locomotive Works.....	October 10, 1853	25
Wabashaw.....	Schenectady Locomotive Works.....	October 18, 1853	25
Black Hawk.....	Galena & Chicago Union Railroad.....	January 1, 1854	24
Falcon.....	Chicago Locomotive Works.....	February 6, 1854	25
Beloit.....	Schenectady Locomotive Works.....	March 14, 1854	25
Kansas.....	Chicago Locomotive Works.....	April 1, 1854	25
Geneva.....	New York Locomotive Works.....	April 21, 1854	24
Dixon.....	Schenectady Locomotive Works.....	April 21, 1854	25
W. McQueen.....	Schenectady Locomotive Works.....	May 9, 1854	28
John Ebbert.....	Schenectady Locomotive Works.....	May 10, 1854	28
Oregon.....	Schenectady Locomotive Works.....	May 31, 1854	28
Sterling.....	Schenectady Locomotive Works.....	June 5, 1854	28
W. H. Brown.....	Chicago Locomotive Works.....	June 17, 1854	25
Thos. Dyer.....	Chicago Locomotive Works.....	July 27, 1854	25
Fulton.....	Schenectady Locomotive Works.....	August 23, 1854	25
Nebraska.....	Rogers, Ketchum & Grosvenor.....	September 13, 1854	28
W. S. Hudson.....	Rogers, Ketchum & Grosvenor.....	October 16, 1854	28
Hercules.....	Rogers, Ketchum & Grosvenor.....	November 16, 1854	24
Samson.....	Rogers, Ketchum & Grosvenor.....	November 18, 1854	24
Achilles.....	Rogers, Ketchum & Grosvenor.....	November 18, 1854	24
Winnebago.....	Schenectady Locomotive Works.....	April 18, 1855	28
Como.....	Chicago Locomotive Works.....	April 18, 1855	25
Sauganash.....	Schenectady Locomotive Works.....	April 20, 1855	29
No. 1.....	Rogers, Ketchum & Grosvenor.....	August 18, 1855	25
Clinton.....	Schenectady Locomotive Works.....	August 20, 1855	28
Lyons.....	Schenectady Locomotive Works.....	August 27, 1855	28
Wayne.....	Schenectady Locomotive Works.....	September 24, 1855	28½
Savannah.....	Schenectady Locomotive Works.....	October 8, 1855	28½
Franklin.....	Rogers, Ketchum & Grosvenor.....	October 15, 1855	28
Pecatonica.....	Schenectady Locomotive Works.....	November 1, 1855	26
Grey Hawk.....	Galena & Chicago Union Railroad Company.....	December 1, 1855	26
Nevada.....	Manchester (N. H.) Locomotive Works.....	January 25, 1856	28
Malta.....	Manchester (N. H.) Locomotive Works.....	June 19, 1856	28
Nachusa.....	Schenectady Locomotive Works.....	August 4, 1856	29
Afton.....	Schenectady Locomotive Works.....	September 11, 1856	28
Madison.....	Schenectady Locomotive Works.....	September 18, 1856	28
Fox River.....	Chicago Locomotive Works.....	July 4, 1857	25
Freeport.....	Schenectady Locomotive Works.....	August 31, 1857	28
Caledonia.....	Schenectady Locomotive Works.....	September 30, 1857	28
Roscoe.....	Schenectady Locomotive Works.....	October 15, 1857	28

### Encouraging Growth.

It will be seen that in twenty years the company had come into possession of sixty-one locomotives, representing the product of ten different shops. Of the number named twenty-six had been built at Schenectady and they were popularly known as McQueen engines, from the name of the superintendent of the works. Rogers sold them nine engines and the Chicago Locomotive Works seven.

### Story of a Chicago Built Locomotive.

There are few of my readers who will know that the Chicago Locomotive Works, owned by Scoville & Co., were ever in existence. There is an engineer story wherein a McQueen and

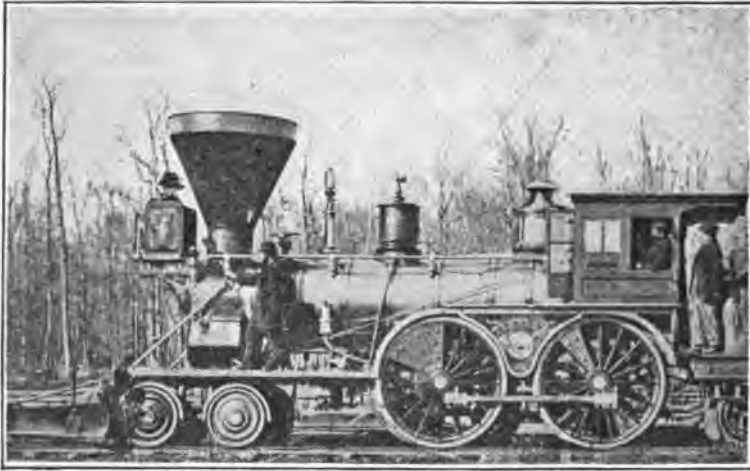

Fig. 160. The "Persian," a Detroit Built Locomotive

a Scoville engine engaged, competing performances which is worth repeating.

Scoville & Co. went into the work of locomotive building ambitiously in 1853. They had a shop known as the Chicago Locomotive Works, at the corner of Canal and Van Buren streets, well filled with tools, and fairly well adapted for the work they were going into. The burning ambition of Mr. H. H. Scoville, the head of the firm, was to build locomotives that would eclipse the McQueen engines, which were then the pride and boast of Western railroad men. He had at one time some connection with the Norris Locomotive Works, in Philadelphia, and he

believed that the Norris engine could beat creation, and his first engine was modeled after the Norris pattern.

This engine was called the "Enterprise," and had the hemispherical fire-box and other features so well known to Norris engines. Before that locomotive was sold, the builders found that the world of locomotive design was advancing, and that haystack fire-boxes were no longer in demand. The next engine turned out in 1854 was the "Falcon," which had the ordinary wagon top boiler, and the intention was to demonstrate with it that Chicago builders could make locomotives that would leave other builders away behind. The engine had cylinders 15×22 inches and two pairs of driving wheels 66 inches diameter. It was intended for the heavy passenger service of the time.

At this time the Galena & Chicago Union Railroad was considered the crack line of the West. The road was stocked largely with McQueen, as Schenectady engines were called, and the men running them were firm believers in their superiority to anything running on wheels.

### Famous Galena Engineers.

The Galena road was supposed to have a set of the ablest engineers that ever pulled a throttle lever. Nearly all of them afterwards filled positions of importance and trust in the railroad world. Among them were George I. Chalender, who was afterwards superintendent of motive power of the Chicago, Burlington & Quincy; John Ebbert, the first locomotive engineer on the road, who afterwards filled several important positions; Thomas Burgess, who became master mechanic of the Chicago & Northwestern; I. B. Bowen, I. D. Johnson, Robert Hoffman, Wm. B. Brown, Dan McMann, H. P. Vedder, Aaron Hathaway, George Rolf, and others of almost equal celebrity. All old Western railroad men will recognize these names.

The Galena road bought the first five Scoville locomotives, and a spirit of emulation seized the men assigned to the engines to compete successfully with the McQueen already in service. The Falcon was assigned to Robert Hoffman, who was an intimate personal friend of the builders, and was noted among railroad men as a noisy, pretentious, whoop-her-up type of engineer. He guaranteed to hustle the engine into the front rank on the first fair trial. This was to be made as soon as the engine was in good running order on the morning passenger train west bound from Chicago.

When the eventful day arrived, the Falcon coupled on to sixteen passenger cars and pulled out in the midst of an ovation given by the friends of the builder and the admirers of Hoffman. Hoffman was noted for overweighting the safety valves, and it was understood that he carried on this occasion over two hundred pounds of steam. At all events, it was discovered before he was done competing that the crownsheet was bagged between the stay-bolts through the effects of excessive pressure. On this occasion, however, carrying recklessly high pressure did not avail, for he lost two hours in the run of 120 miles to Freeport.

Next day a McQueen engine, of the same size as the Falcon, coupled on to the same train, but consisting this day of seventeen passenger cars, and pulled out thirty-five minutes later, Thomas

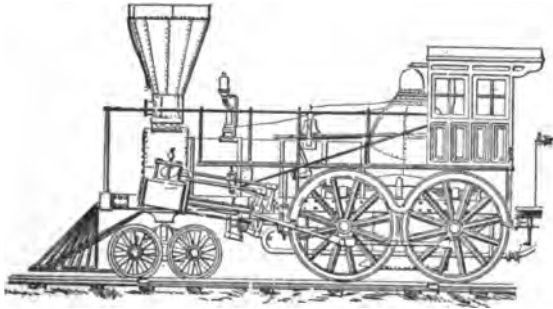

Newcastle Co. (Delaware), 1852. For Newcastle & Frenchtown  
Railroad

Burgess being engineer. This train ran to Freeport and made all the stops and reached the end of the trip five minutes ahead of time. The Falcon was beaten, and Chicago's locomotive enterprise received a blow from which it never recovered.

All Hoffman's energy and schemes failed to make the engine a success. It was tried on all kinds of service, but in every case failed to come nearly up to the performance of other engines of the same class. Other engines subsequently built by the same firm did their work about as well and as economically as the McQueens, but the Falcon was worthless. It turned out to be the kind of bird that would neither fly, run nor pull, and Hoffman gave the engine up in disgust and accepted a position as master mechanic on a road in Wisconsin.

### Belief in Mysterious Influences on Engines.

The belief which still lingers among many railroad men that a group of engines may be built from the same templates, and that one engine may turn out much better or much worse than the others, was very strong in those days, and most of the engineers and other mechanical men belonging to the Galena road believed that the trouble with the Falcon was some species of incomprehensible but incurable perversity.

### Cause of Failure.

Most of the people directly interested in getting the engine to work properly gave it up as a hopeless case. This opinion was not, however, shared by Wm. Wilson, who was for years superintendent of machinery of the Chicago & Alton Railroad, who was then a gang boss in the Galena shops at Chicago. One day when the engine was in for repairs he obtained permission to give it a thorough investigation. In the first place he went over the valve motion and found that to be in about the same condition as the valve motion of the other engines. Then he took the dome cap off and examined the throttle, and found that nothing obstructed the admission of steam into the dry pipe. The steam passages between the steam chest and cylinders were next subjected to searching scrutiny, but there was nothing there to prevent the steam from passing through freely. The case looked puzzling, but Mr. Wilson had infinite faith in steam acting the same part in that engine that it did in others, if permitted to reach the cylinders; so he determined to follow the passages back to the throttle valve. As a preliminary, he took down the steam pipes and found they were in about the same condition as the steam pipes of the other locomotives. Then he got up to the branch pipe with the intention of feeling inside the dry pipe, but there an obstruction was found. The branch pipe was taken down, and it was discovered that a centering plate which was fastened to the dry pipe when the joint was being turned, had not been removed, and all the opening left for the steam to pass through was two  $\frac{3}{8}$ -inch holes which were in the plate. When the plate was removed, the Falcon proved as good an engine as any of its inches on the road, but its first bad performance inflicted such severe injury to the reputation of its builders that it hastened their failure, which came a year or two later.



### Illinois Central Railroad.

What is regarded by many people as the most important railroad in the West was the Illinois Central chartered in 1851 and heavily subsidized by the State of Illinois. The purpose was to traverse the whole State from Chicago to the southern line. The work was very expeditiously done for those days and for years the Illinois Central was the longest railroad in the world.

It exerted no influence on the development of the locomotive, therefore it does not come within the scope of this book. But the company inherited from one of its proprietary lines, a pioneer locomotive now in the Field Museum, which deserves



Fig. 161. Illinois Central Locomotive "Mississ'ppi"

some attention. This is the "Mississippi" which belonged to the Natchez & Hamburg Railroad.

#### The Locomotive "Mississippi."

The meager history preserved of the engine says that it was imported from England about 1836, but I am inclined to doubt the correctness of this statement. It has none of the characteristics of any English builder of that period. It is on record that Samuel B. Dougharty, for some years assistant to W. T. James, had gone to work for H. R. Dunham & Co., of New York, who had engaged in the business of partly building, partly assem-

bling locomotives, and that in 1836 he took several locomotives from New York to the Natchez & Hamburg Railroad. The likelihood is that the "Mississippi," now to be seen in the Field Museum of Chicago, was one of these. H. R. Dunham & Co. bought parts mostly in England, and put them together, making the minor fittings in their own shops, and contracting in New York for the boilers. In 1835 they built for the Engineering Transportation Company a locomotive which was spoken of as being the most thoroughly American locomotive ever built, so it is highly probable that the Mississippi was of a similar pattern, for it is thoroughly American without a single English feature.

The latest record we have of the engine is, that in 1868 it was removed from Natchez to Vicksburg. It was used there switching for a time and was then put in a remote siding, where it became buried in sand, until 1878 when it was exhumed and put to work on the construction of the Meridian, Brookhaven & Natchez Railroad. When that short line was finished the Mississippi was employed pulling trains until 1891. The engine weighed 14,000 pounds, had cylinders  $9\frac{1}{2} \times 16$  inches and driving wheels 43 inches diameter.

#### Dr. Lardner's Passive Testimony.

About the year 1845 Dr. Dionysius Lardner, a celebrated English writer on transportation problems, visited the United States for the purpose of investigating the progress of railroad construction. During his tour he traveled in Mississippi, probably behind the engine "Mississippi," and he thus describes part of the journey: "To the traveler in these wilds, the aspect of such artificial lines of transport (railroad) in the midst of a country a great portion of which is still in the state of native forests, is most remarkable and strongly characteristic of the irrepressible spirit of enterprise of its population. Traveling in the back woods of Mississippi, through native forests where, till within a few years, human foot never trod, through solitudes the stillness of which was never broken even by the red man, I have been filled with wonder to find myself drawn on a railway by an engine driven by an artisan from Liverpool, and whirled at the rate of twenty miles an hour by the highest refinements of the art of locomotion. It is not easy to describe the impression produced as one sees the frightened deer start from its lair at the snorting of the pon-

derous machine, and the appearance of the smokelike train which follows it, and when one reflects on all that man has accomplished within half a century in this region."

Dr. Lardner was a most bigoted Englishman, and he would not have failed to mention it if the locomotive had been of English manufacture.



Stuyvesant Fish, President of Illinois Central,  
Whose Influence Preserved the  
Locomotive "Mississippi!"

# Locomotive Boilers

## CHAPTER XXIII.

As a locomotive is a combination of boiler for generating steam and engine for using the steam to the best advantage in the performance of work the history of both progress together.

### Considerations of the Designer.

Persons who design boilers for supplying steam to engines follow certain well-established rules in order to make the boiler suitable for its purpose. In the first place they have to calculate how great a volume of steam per minute or hour the boiler will be required to generate, and they arrange the proportions to meet the requirements. With a certain velocity of draft the surface of a boiler exposed to the fire may be depended upon to evaporate a certain weight of water per hour when the grate is large enough to burn the fuel freely. The three leading factors in boiler design are therefore: the character of the draft to be employed; the amount of heating surface, as the parts exposed to the fire gases are called; and the extent of grate area.

Besides arranging that a boiler shall be equal to the requirements of steam making, there are several other important considerations that demand the care of the designer. Among these are strength sufficient to resist the pressure inside, durability, smallness of bulk and weight, free circulation of the water, ease of access for inspection or good provision for cleaning, and economy of fuel.

### Survival of the Fittest.

There is a great variety of steam boilers in use, and a vast variety of forms have been tried and abandoned as unsuitable. The best known existing forms of steam boilers have held their own through a prolonged process of natural selection, and have been adopted because they were the fittest for their purpose.

### Globular Boilers.

The globular boiler was the first form employed to generate steam much above atmospheric pressure, and was no doubt chosen

because it is the strongest natural form for resisting pressure. It was also the first move of progress above the domestic caldron, the first steam making boiler. With a globular vessel pressure within puts equal strains on the whole of the surface, and there is no tendency to distort the contour. Soap bubbles, toy balloons and numerous other objects supply illustrations of how strong the globular form is to resist inside pressure.

The experiments made with steam engines and boilers during what has been called the "speculative era" of the steam engine were all carried out by philosophers and scientists, so it was natural that they should cling to the strongest theoretical forms in designing boilers. The globular boiler was the favorite form in use until the improvement of the steam engine fell into the hands of practical mechanics. The first form of furnace used was a plain

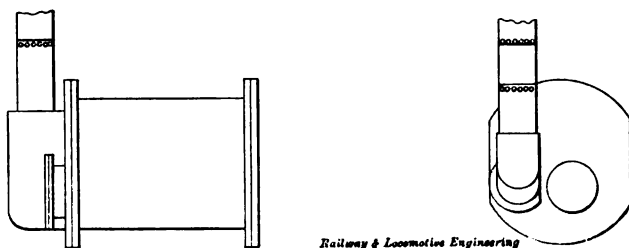

Fig. 162. Trevithick's Return Flue Boiler

hearth made of brick or other refractory material, and the first important improvement effected was the raising of the fire and placing it upon grates, which permitted the air necessary for combustion to enter beneath the fire.

Although the solid hearth was early abandoned by steam makers, owing to the difficulty of supplying the necessary air to the fuel, its use was several times revived by inventors of smoke preventing furnaces, and it is now employed largely in metallurgical operations.

### The Cylindrical Boiler.

The principal shortcoming that a globular form of steam boiler suffers from is that it provides very little heating surface. When practical mechanics began to work out the necessary appurtenances of a steam engine that would do work more cheaply than other forms of power, they quickly adopted the cylindrical form of boiler, which is strong, of simple shape and provides a large surface for the fire gases to act upon to heat the water within.

In connection with the cylindrical boiler the oblong furnace with a bridge in front came into use. In this arrangement heat is applied directly to the bottom of the outside shell. The bridge was not applied for many years after the oblong furnace was introduced, but the combination is nearly as old as the modern steam engine. With skillful firing, and with means provided for admitting air over the fire, this furnace can be made to burn coal as economically and as free from smoke as any ever invented. Another good thing about this furnace is, that there is nothing in its construction which a common fireman cannot understand.

### **The Cornish Boiler.**

An improvement on the plain cylindrical boiler, which had the furnace outside and had merely the bottom plates for heating surface, was the Cornish boiler, which had a large single flue through the center of the water space and had the furnace at one end of this flue. The next step in boiler development was to put in a return flue, so that the fire gases passed twice through the boiler. The first practical locomotive, or at least the first locomotive to perform everyday work of hauling cars, had a boiler of this kind. It was built by William Hedley in 1813. It had previously been used by Richard Trevithick, and is shown in Fig. 162.

An improvement on a single large return flue was two smaller ones, which gave much more heating surface for the space occupied. This line of development gradually led to the modern multitubular boiler. When a boiler flue is smaller than 3 inches diameter it is usually called a "tube." This brings up to the modern locomotive boiler.

### **Development of the Locomotive Boiler.**

Those pioneer engineers who gave to the world the high speed locomotive with all the essential parts complete, performed a very difficult problem when they designed a suitable boiler. Before the work was done the difficulties seemed insurmountable. Two conflicting elements had to be harmonized. The problem called for the lightest form of boiler that had ever been used, and at the same time it must generate steam ten times faster than the boilers most commonly in service.

American inventors, whose genius had been stimulated by the demand for fast steaming boilers for river steamers, had made the engineering world familiar with various forms of multitubular and water tube boilers, but neither of these seemed suitable for loco-

motives, as most of them required a built-up furnace. To use an internal furnace in a large flue and then small return tubes above, called for a larger boiler than was considered permissible with a locomotive. A fire box seems a simple expedient after we have seen it applied, but it was a tremendously difficult undertaking for those who first experimented on that arrangement.

### Invention of the Fire Box.

Various inventors and engineers had proposed employing a fire box in combination with the multitubular boiler for locomotives, but there were difficulties of construction in the way that the pioneer boiler makers were slow to overcome. The first engineer to apply to practical use the combination of a multitubular boiler and fire box was Mr. Marc Seguin, of the St. Etienne Railway of

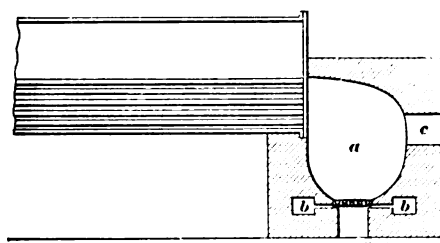

*Railway & Locomotive Engineering*

Seguin's Multitubular Boiler, 1827

France. In the beginning of 1829, he changed the boilers of two locomotives bought from the Stephensons, and built them in the form shown in Fig. 163. In this the water did not surround the fire box. Referring to the engraving it will be seen that the fire box was a detached chamber, so secured that the fire gases passed directly into the boiler tubes. A fatal objection to this form of fire box was that the material soon burned out. When it was lined with brick the rattling of the engine quickly shook the structure apart.

Detached fire brick boxes have been experimented with a great deal at various times during the last sixty years. Not a few modern engineers believe that a fire box lined with fire brick would be more economical than the common form, which has plates surrounded by water, because a higher furnace temperature would be maintained. The Verderer boiler, which was tried in Germany about 1880, had a brick-lined fire box. Apart from the tendency of this form of fire box to shake to pieces, a still more serious difficulty arose against its use. The boiler tubes received the

fire gases at such a high temperature that no means could be devised to keep them from leaking.

### The Modern Fire Box.

Seguin's experiment with the detached fire box with solid sides was a highly important step forward, but the prototype of the modern fire box appeared in Stephenson's "Rocket," which was built in 1829. The general arrangement of this fire box is shown in Fig. 164. The furnace is a double box, one inside the other, with a water space separating the two shells. It was secured to the back boiler-head, and had circulating pipes on each side to keep the water moving between the body of the boiler and the fire box. Within the two years after this fire box was put into use the locomotive

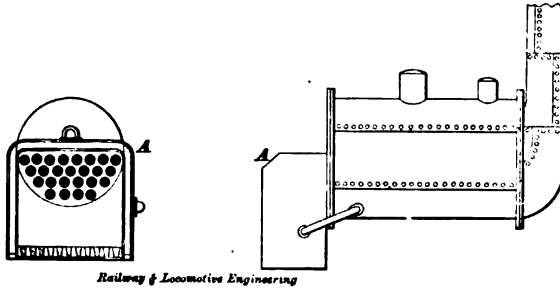

*Railway & Locomotive Engineering*

Fig. 164. Stephenson's "Rocket," 1829.

fire box reached its present shape in small forms of engines. Very few locomotives were afterwards built without fire boxes.

No invention connected with improved methods of transportation received such general and cordial adoption as the locomotive fire box. Yet, strange to say, there is no part of the locomotive except the link-motion that has been the object of so much fault-finding. It is reputed to be the worst kind of form to withstand pressure successfully, it does not lend itself conveniently to the putting in of a large enough grate, it is awkward to make and hard to maintain in good order, while its particular sides are a vicious form of heating surface. Substitutes without number have been offered, and the highest engineering indorsements testified that they were likely to be much superior to the fire box, yet somehow this ridiculous paradox on engineering perfection would not be suppressed, and it continues to hold its own, while all its rivals slip one after another into quiet oblivion.



Stephenson's Rocket took the prize at the Rainhill trials of the Liverpool & Manchester Railway in 1829 principally through the efficiency of the boiler. Engravings of two other boilers used on engines that took part in that contest are shown, viz., Hackworth's return tube boiler, Fig 165, and Ericsson's combined water tube and furnace boiler.

### Vertical Boilers for Locomotives.

Vertical boilers were in decided favor among those who first built locomotives for railroads in the United States. Cooper used a boiler of this character for the small locomotive he had built for the Baltimore & Ohio Railroad in 1829, and others enlarged on his form, particulars being given in Chapter V.

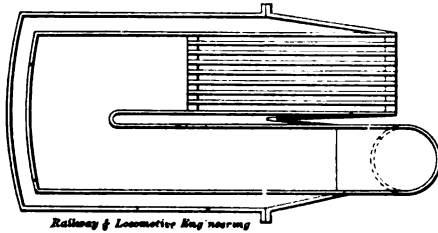

Fig. 165  
Hackworth's Return Flue Boiler. Used in  
"Nonpareil" Engine, that was in com-  
petition with "Rocket," 1829.

Cooper's tiny engine had a multitubular boiler, gun barrels having been employed as tubes. American locomotive engineers never considered that the Stephensons deserved particular credit for introducing a tubular boiler, for that form had long been used in the United States for steamboat service. In 1825 Colonel John Stevens built a small locomotive and ran it about his grounds in Hoboken to demonstrate that railroads were practicable. That engine had two lantern tubular boilers with tubes arranged vertically in circles about the furnaces. One of these boilers is still preserved in the Stevens Institute of Technology, Hoboken, N. J.

### Bury's Boiler and Its Influence.

The form of locomotive boiler that led the way to the shapes of to-day was the type, Fig 167, designed about 1829 by Edward Bury, of Liverpool, England. Many Bury locomotives were im-

ported into the United States in early railroad days. This boiler had a hemispherical fire box which gave it the popular name of the "haystack" boiler. That form found much favor among railroad mechanics. The plan of the fire box was the form of the letter D, the perpendicular side being the tube plate. Baldwin adopted it in his second locomotive, and for a time nearly all locomotive builders in the United States, excepting those in New England, followed the same practices.

### The Stephenson Boiler.

New England locomotive builders followed the lead of the Locks & Canal Company in their imitation of Stephenson's small engines

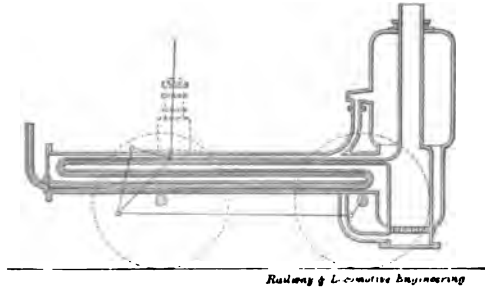

Fig. 166. Boiler of Ericsson's "Novelty"

which had the fire box outside sheets raised about six or eight inches above the top line of the boiler. Hinkley built some engines with square fire boxes, the top being flush with the barrel of the boiler. Some of those who did not use the Bury boiler seemed to perceive the advantage of having liberal steam room above the fire box and they raised the top from six inches to about twelve inches. This practice was very common in Europe. The abrupt rise made a weak spot at the waist and that feature of construction was gradually abandoned.

### Dripps Boilers.

As early as 1832 Isaac Dripps, of the Camden & Amboy, had straight boilers made for locomotives built in Hoboken. They had an unusually large fire box, Fig. 168, for that period and a short combustion chamber which was the first ever applied to a locomotive. There was a large dome set near the smoke stack and a raised manhole immediately in front of the fire box.

Considering the time of its construction, only three years after the first water protected fire box and multitubular boiler appeared, this was a remarkably well designed boiler and embraced forms and proportions that approach the best modern practice. The leading features are heating surface equal to the engine's requirements, large fire box and liberal grate area, plenty of steam room and a form that combines maximum strength with lightness.

Another striking thing about the pioneer boiler was the ingenious provisions made for spark arresting. There are the deflector plates above each row of tubes, an invention claimed years afterwards by various candidates for engineering honors, and the double pipe smokestack with cone, which was the basis of successful smokestack making up to the time that the use of coal as fuel became general.

In 1847 Dripps brought out a peculiar form of boiler, shown on

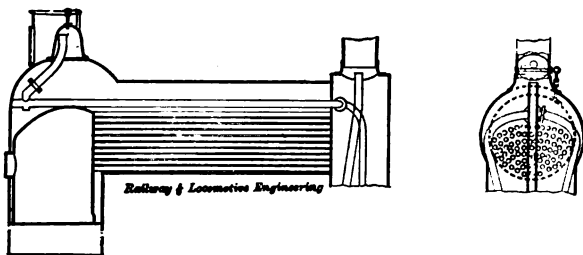

Fig. 167. Bury Boiler, 1840.

page 95, for some Crampton engines that were built by Norris. The fire box was 6 feet long and 3 feet 6 inches wide, giving a grate area of 21 square feet. A very large dome was located well forward.

These boilers burned anthracite fairly well, but they appear to have exercised no influence upon the permanent development of the locomotive boiler.

The De Witt Clinton; had a huge dome in the middle of the boiler, and some of the early Hinkleys were built in the same way. Wilson Eddy had good ideas concerning the strength of boilers and adopted the straight shape without any dome. The steam was drawn from a perforated dry pipe, with the throttle valve in the smoke box. This is the strongest boiler that can be made.

About the time that the change from the Bury boiler was made some straight boilers came into use, but they were never so popular as those with the wagon top. The leading advantages claimed

for the wagon top boiler are that it provides for more tubes being used than a flush top fire box, it gives more steam room and also more room for workmen, and thereby facilitates construction and repairs.

### Rogers Applies Wagon Top.

Rogers applied a wagon top boiler to an engine in 1850 and the change to that form progressed steadily. With increase in the other dimensions of the locomotives the Bury fire box was too small for the increased quantity of fuel that had to be burned, so a very good servant had to go the way of all the earth. No boiler was ever more popular on American locomotives.

The change from the Bury boiler and from those that had a

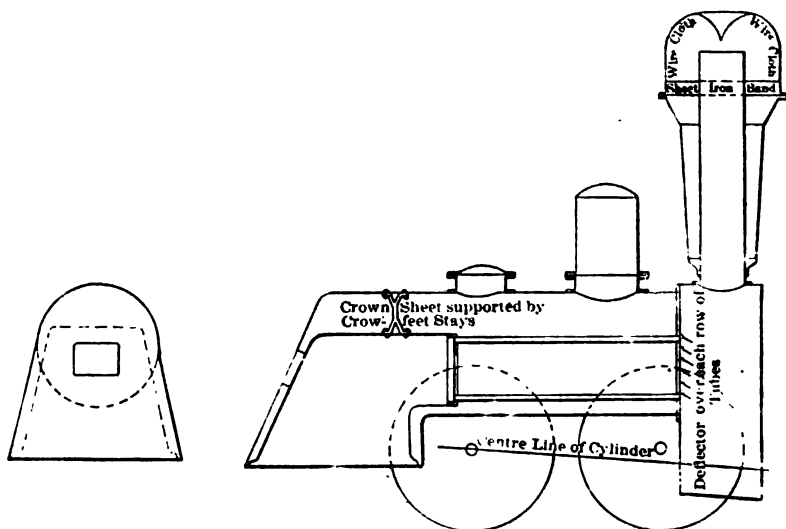

Fig. 168. Dripps Boiler, 1832

slightly raised fire box shell crowned by a dome, as in the early Stephenson locomotives, brought that part of the engine up to modern practice, most of the advance being in the form of enlargement and the introduction of what is known as the extension wagon top. Many experimental boilers were tried, but they all passed away except the Belpaire, the straight boiler and a few others of modern design.

### European Practice.

European locomotive boiler practice, both in Great Britain and on the Continent, began with the Stephenson type, having the

raised fire box. British designers worked gradually to the straight boiler with deep fire box between the frames, although of late years our shallow fire box extending over the trailing wheels is coming into fashion. A few locomotives are to be seen there with Belpaire fire boxes, and the Great Western has been introducing an odd form of wagon top boiler, but the standard practice is straight boilers.

Continental practice gradually drew away from the Stephenson boiler and straight boilers with huge domes came into favor. In some quarters numerous Belpaire boilers are to be seen, especially in Belgium, where the inventor was a railway engineer.

### Peculiar Forms in United States.

A great many peculiar forms of boilers were produced in the United States through efforts, first, to burn anthracite coal, and

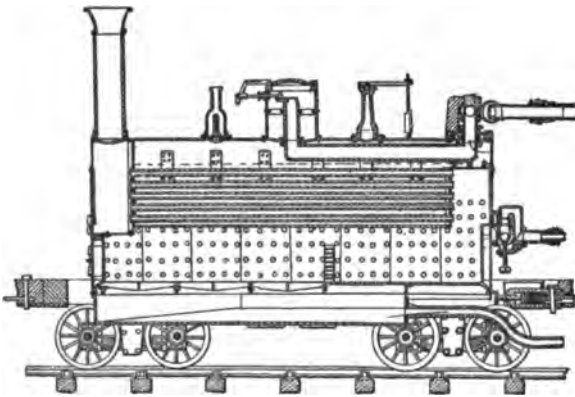

Fig. 169. Boiler of Nichols' "Novelty"

second, to use soft coal as fuel. The first recorded attempts of this character were made by Isaac Dripps, already referred to.

The small experimental engine which Peter Cooper had built for the Baltimore & Ohio Railroad burned anthracite and several of the pioneer locomotives burned the same fuel, but they all suffered from contracted grate area. The first successful attempt to produce a locomotive to burn anthracite successfully was made by Ross Winans in some engines which he built for the Philadelphia & Reading in 1847. The boilers of these engines were 42 inches diameter with tubes 14 feet long. The grate area was 18 square feet and the total heating surface was 957 square feet. The fire

box is illustrated in Fig. 121, Chapter XVIII, which was a sort of two-story box with two fire doors, but only one set of grates. That form of locomotive was gradually developed until it assumed the Camel type which burned any kind of coal successfully.

James Millholland, of the Reading Railroad, did valuable work in developing the anthracite burning boiler, particulars of his work being given in Chapter XVIII. A boiler that Millholland condemned was the freak illustration in Fig. 169, designed by G. A. Nichols for



Mr. O. H. Reynolds, Mechanical Engineer,  
Who Gave Valuable Assistance on  
the Chapter on Boilers

the Philadelphia & Reading Railroad to burn anthracite coal. It has already been described.

In 1854 Zerah Colburn, mechanical engineer of the New Jersey Locomotive & Machine Works, designed some engines for the Delaware, Lackawanna & Western, one of which, the Lehigh, had a fire box 7 feet 6 inches wide and 6 feet long, full particulars being given in Chapter XIX. This was, no doubt, the progenitor of the wide fire box engine known among train men as Mother Hubbard, and of the Wootten.

The Wootten boiler which was patented by John Wootten of

the Philadelphia & Reading Railroad in 1877 differs from the Colburn boiler in being made to extend over the driving wheels while that of Colburn extended behind the wheels. There were also some minor differences in details.

A compromise between the Wootten and the ordinary locomotive boiler is that having a wide fire box extending outside of the frames first introduced in 1892 on Baldwin's Columbia, but better known in connection with Atlantic type engines.

### Vanderbilt Boiler.

In 1899 Cornelius Vandervilt made a bid for popularity and improvement with a fire box consisting of a single corrugated flue. Its chief merit was in doing away with the necessity for stay bolts.

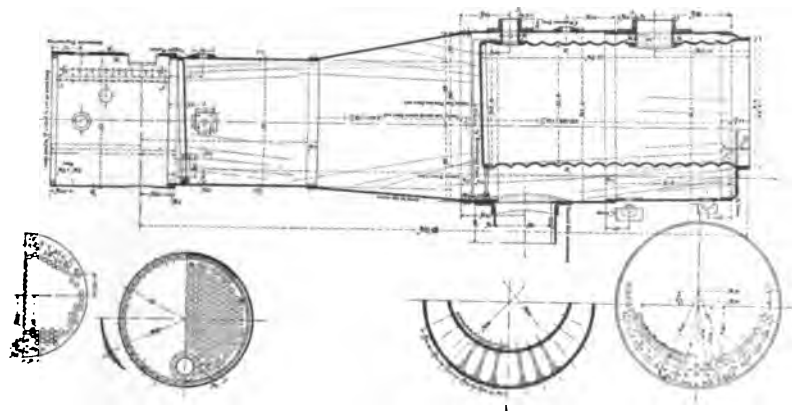

New York Central Locomotive Boiler, with Corrugated Furnace. Designed by Cornelius Vanderbilt

Several engines with that form of furnace were put into service but they proved short lived.

The purpose of Mr. Vanderbilt's invention was of the very first importance, and it would have succeeded under ordinary circumstances, but it would not endure the terrible usage it was subjected to. The boiler made steam so freely that the engine was forced in many instances to perform double service, with the result that the sheets were distorted from excess of heat. The merits of the boiler proved its undoing. It would endure excessive forcing without showing distress, where stay-bolt boilers would have displayed warning signs, so in some instances it was given double duty to perform. Because there was a limit to its endurance and because it departed from the stereotyped forms, it failed to achieve popularity.

Experience with the Vanderbilt boiler using liquid fuel, for which it was particularly well adapted, gave valuable experience lessons as to how far the ordinary fire box will withstand high temperatures long sustained. The Vanderbilt furnace did not collapse under extraordinary forcing of oil flame, and attempts were made to make stay-bolt fire boxes approach the performance of the corrugated furnace, with the result that they failed immediately. The inability of the ordinary fire box to withstand the heat of the high combustion is due to the fact that natural circulation will not cover the heating surface with water as fast as it is evaporated.

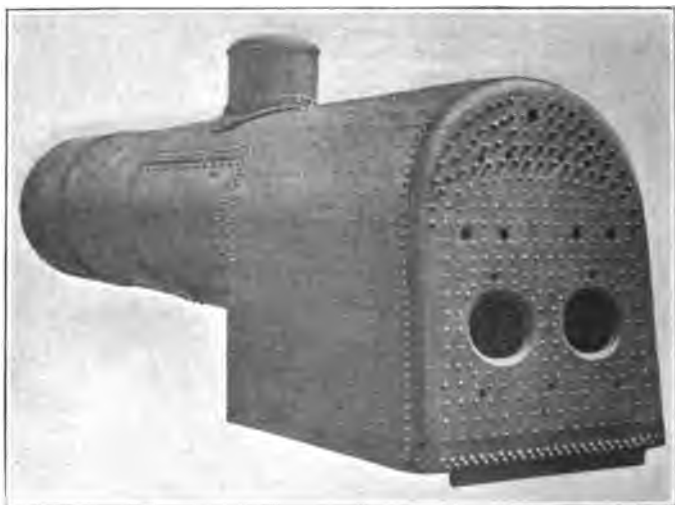

A Modern Locomotive Boiler

The lesson impressed upon railroad men was that boilers cannot be indefinitely forced with impunity.

Even more ambitious than the Vanderbilt experiment was that made by George S. Strong. His engine had two circular corrugated furnaces joined to what was called a breeches pipe, leading to a corrugated combustion chamber. The boiler was intended to burn anthracite but its performance was not superior to ordinary types made at one-third the cost.

What may be called the leading modern improvements on locomotive boilers have been the abandoning of crown bars for radial stays and the close attention given to rivetted joints, which are



invariably of the butt joint type with welt strips for the longitudinal seams giving an efficiency of about 90 per cent. of the solid plate. This care in design and construction is rendered necessary by the high steam pressure that has become regular practice.

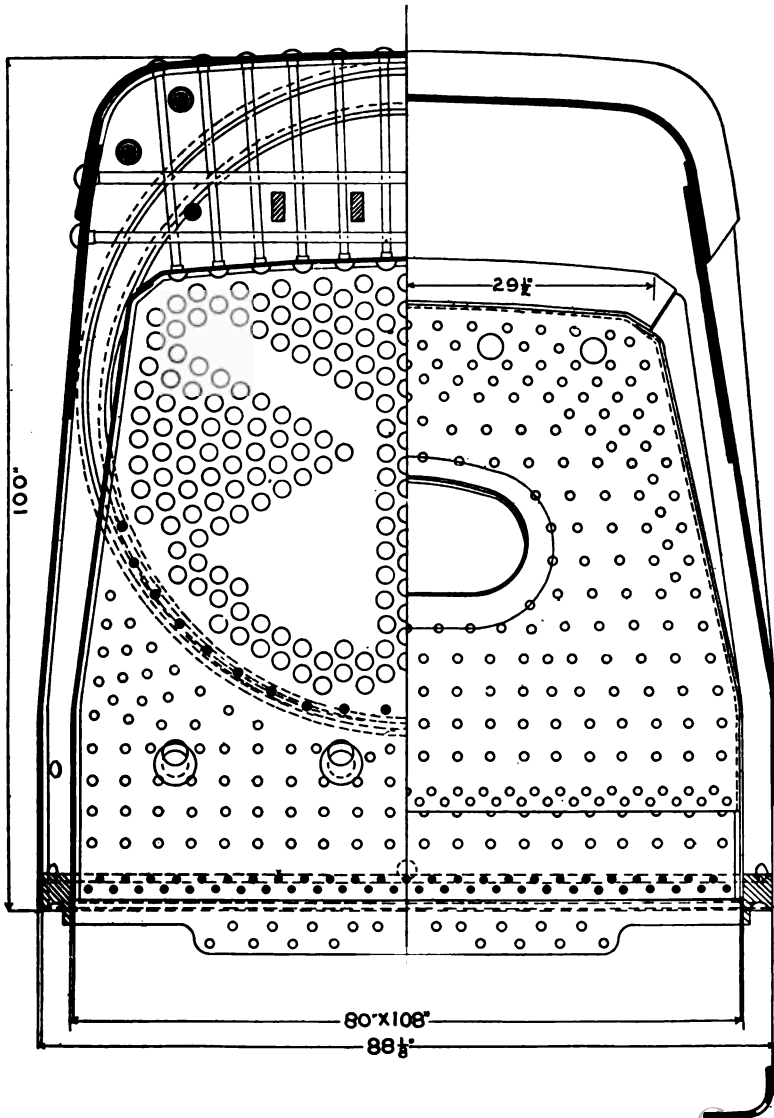

# Smoke-Preventing Appliances

## CHAPTER XXIV.

The locomotive had been only a few months in use when a demand for smoke prevention arose. In 1813 when William Hedley's celebrated engine, Puffing Billy, was put into service the people objected to its use on account of the smoke it made. To cure this the inventor conducted the smoke into a reservoir and through a pipe leading from thence into the stack. At the same time the exhaust steam was passed through the smoke stack to whiten the smoke. This, however, created a draft through the smoke stack

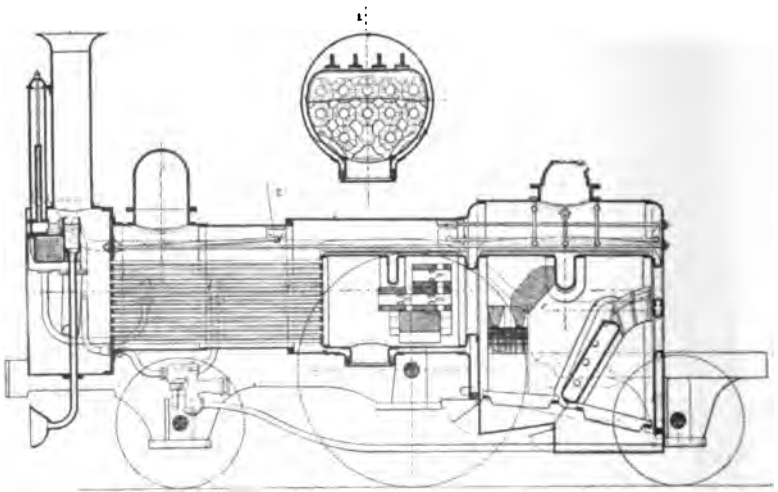

Fig. 170. Beattie's Smoke-Preventing Boiler

which drew sparks from the fire, creating a new complication, which had to be dealt with in the course of time by the inventing of spark arresters.

### Introduction of Coal Burning.

The most important question occupying the attention of railway mechanical men during the fifth and sixth decades of last century, was the burning of bituminous coal in locomotive fire boxes. Most of the difficulties encountered originated in the fall-

acy that bituminous coal could not be burned in fire boxes designed for the combination of wood or coke without radical changes in design being carried out.

### Smoke Prevention Demanded.

The prejudice that existed among the mass of the people against railroads in the early days, led to the imposition of many embarrassing restrictions upon the companies, one of them being that the locomotives should burn coke or consume the smoke if bituminous coal was burned. That condition was imposed upon those who built engines for the Liverpool & Manchester Railway Company and for the locomotives operating all British railways. It was also imposed by the directors of the Baltimore & Ohio Rail-

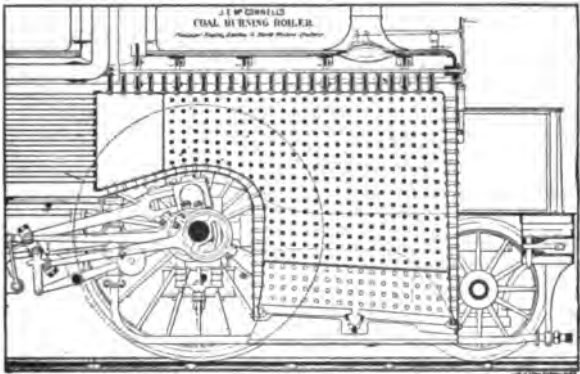

Fig. 171. McConnell's Coal Burning Fire Box

road when they offered a prize of \$4,000 for the best native built locomotive.

### Prejudice Against Coal Burning.

The burning of coal was by no means common in the United States for domestic purposes in the middle of the nineteenth century, and there seems to have been strong prejudice against its use. Its smoke producing properties also raised prejudices against "sea coal" in Great Britain, for as late as 1850 D. K. Clark, the celebrated engineer, who was an exponent of scientific opinion, wrote: "Coal, at least of the ordinary bituminous kinds, ought not to be used as a staple fuel at all. It is the mere raw material of fuel—the ore from which coke is extracted, and contains some valuable compounds which, on the one hand, ought never to be thrown into the

furnace, and, on the other, ought not to be wasted by the prevailing method of coking. At some time hence it will be difficult to believe that those hydro-carbons, some of which were in themselves so valuable, are actually burned off and lost in the process of coking. The more difficultly manageable of these compounds are obtainable from the coal at temperatures so low and so easily, and yet are so valuable from the oil alone, that the fact cannot fail much longer to attract spare capital and open up a new manufacture of which we cannot meanwhile guess the extent. Ultimately green bituminous coal will be entirely abandoned as the staple fuel for either locomotives or any other class of boilers."

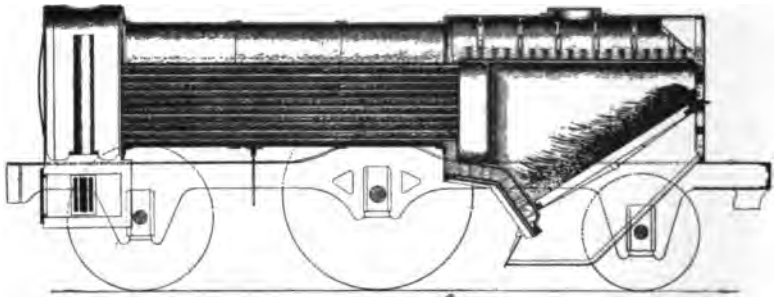

Fig. 172. Cudworth's Coal Burning Boiler

That was one of the prophecies that proves the sense of the saying, "Don't prophesy unless you know," but the sentiment was popular in the scientific world at the time it was written.

Owing to the restrictions concerning the smoke nuisance, the railway companies in Europe inaugurated the operation of their locomotives by burning coke. Although Cooper's "Tom Thumb," the first native built locomotive of the United States, burned anthracite coal, nearly all its early successors burned wood, which was the popular fuel of the country.

### Call for Reduction of Fuel Bills.

For the first ten years of railway history the cost of fuel for operating locomotives received little consideration, because those in charge of the motive power, devoted their attention principally, to the developing of an engine that could be depended upon to haul trains punctually without failures of any kind. When this had been accomplished, the inevitable ques-

tion of fuel economy came into prominence. European engineers were compelled to work out the problem of substituting bituminous coal for the expensive coke, which had lost a large proportion of heat producing elements of the coal in the process of making. Wood soon began to be expensive in those portions of the United States, where railroads were most numerous, and railway master mechanics were compelled to devote themselves to the work of adapting the locomotives to the combustion of coal.

### Influences That Opposed Common-Sense Fire Boxes.

There were two influences which combined to render the task of adapting the locomotives in use to the combustion of

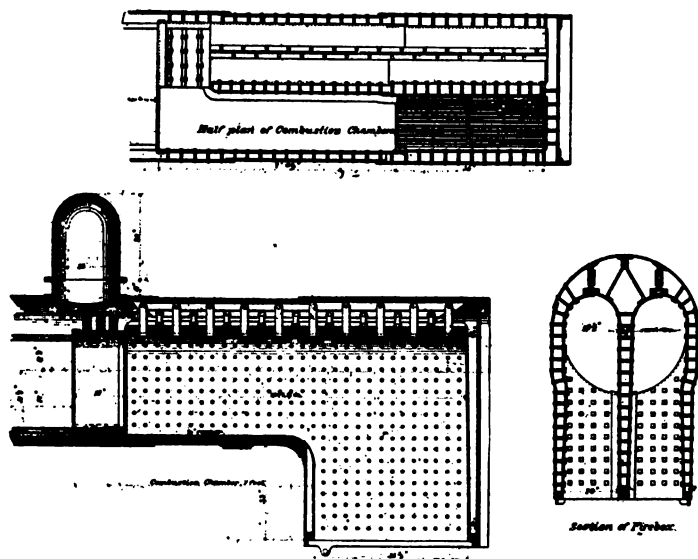

Fig. 173. Another McConnell's Coal Burning Boiler

coal extremely difficult and erected obstacles that were largely imaginary. Scientific writers, whose councils were accorded to be of the utmost importance, insisted that air should be thoroughly mixed with the fuel gases, and a journey as long as possible given to the products of combustion before they entered the tubes. On the other hand, a multitude of inventors of coal burning locomotive boilers came into the field, and all insisted that the use of their boiler was the only way that railroad companies might expect to profit from the use of cheap fuel.

### The Beattie Boiler.

The teaching of scientific pretenders, and the claims made by people interested in special forms of so-called coal burning boilers, led to the invention of a multitude of complex fire boxes, of which the Beattie furnace, illustrated in Fig. 170, was for a time considered the nearest approach to sound scientific principles. In this invention the fire box was divided transversely into two compartments by the inclined water space. The two compartments had each separate grates, fire doors, ash pans and dampers. A combustion chamber extended into the barrel of the boiler with a manhole and cover. From this chamber

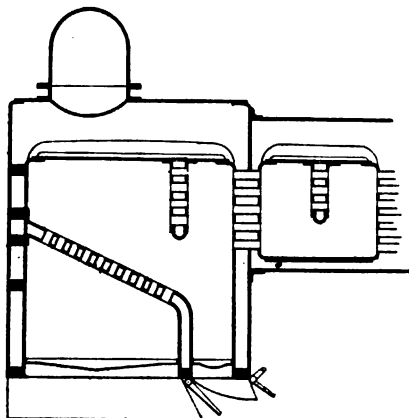

Fig. 174. Dewrance Fire Box

extended the tubes, as in ordinary boilers, but they were unusually small and short. A hanging bridge extended from the crown sheet of the fire box and another from the roof of the combustion chamber. A grating of fire bricks spanned across from the top of the water space to the back of the furnace between the two doors. An arch of fire brick segments was sprung across in front of the combustion chamber. From the top of this arch another set of fire brick reached up to the side of the hanging bridge. In the combustion chamber there was a faggot of fire brick tubes. The doors had each 200  $\frac{3}{8}$ -inch holes for the admission of air.

A great many locomotives belonging to the London & South Western Railway, of which Joseph Beattie was locomotive superintendent, were equipped with his coal burning furnace

between the years 1854 and 1859, and it was said to be a perfect smoke preventer when firing was carefully performed. It is, however, inconceivable that such an elaborate system of gas mixers could be operated except under the influence and supervision of the inventor. Of course, every person familiar with the introduction of inventions pretended to improve railroad machinery know that many worthless or even ridiculous things are made for a time successful when some influential personage is interested, as in the case of the Webb three cylinder compound locomotive; but the test of time passes only things that are fit for their purpose.

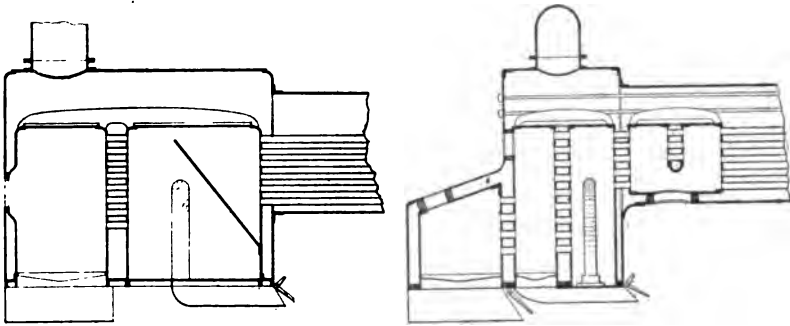

Fig. 175. John Dewrance's Fire Boxes

Incidentally, it may be noted, by students of locomotive engineering, that Beattie's locomotive comprehended several appliances that have been at various times the object of patents in the United States. Conspicuous among these are the feed water heater and the funnel for operating an air ejector in the smoke box.

#### Elements Used in Beattie Boiler.

Beattie's furnace had no new feature even for that early day, but it comprised a variety of inventions which were supposed to constitute a superb combination. The split bridge was invented by Josiah Parker in 1820 and was elaborated about twenty years later by C. Wye Williams, the celebrated apostle of smoke prevention. The water bridge was first applied to a steamboat boiler fire box by Robert L. Stevens, of Hoboken, in 1837. The combustion chamber was patented in England by Stubbs & Gryll in 1846, and perforated openings, by admitting air above the fire were employed long before the days of loco-

motives. The patentees of the combustion chamber did not apply the invention to a boiler, and, as far as I can learn, that was first done in 1832 by Isaac Dripps, as already mentioned in the preceding chapter.

### Inventors of Smoke-Preventing Fire Boxes.

In Great Britain, nearly every locomotive superintendent became the inventor of a smoke consuming fire box, and the best known patterns are here illustrated. The Clark jet arrangement, with openings through the walls of the fire box through which currents of air were induced by steam jets, became the most popular form of smoke preventer, and was used long after the more elaborate devices were abandoned. Before Clark designed the jets for supplying air to the surface of the fire, several inventions had been tried for whitening the smoke by steam

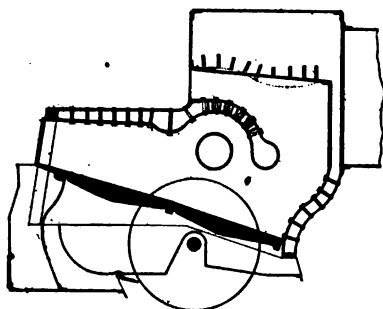

Fig. 176. Craig's Coal Burning Fire Box

forced into the fire box; but, being based upon ignorance of the principles of combustion, they were little used.

### Griggs Applies the Brick Arch.

The pioneer of the United States in the introduction of a smoke preventing fire box was George S. Griggs, of the Boston & Providence Railroad, who, in 1857, applied the brick arch, which is almost the only invention remaining in popular use out of the thousands of devices designed for the purpose of preventing smoke. George Richards, who was associated with Mr. Griggs when the fire brick arch was first applied and who succeeded Mr. Griggs as master mechanic, has given me the following information about the work of his chief:

Mr. Griggs changed a locomotive from a wood burner to a coal burner in 1857. The invention was first applied as a shelf,



straight across the fire box, and consisted partly of fire brick and partly of iron. The second one applied was of common fire brick, 2x4x8 inches each, forming an arch and supported by angle irons bolted to the side sheets.

The third arch was composed of four curved blocks of fire brick 12 inches wide, forming an arch which was supported on T-bolts which were screwed into the side sheets. The changes followed in quick succession and all the locomotives were changed to coal burners as fast as the work could be done.

The cost of wood fuel, the year previous to the introduction of coal, was 35 cents per train mile. The cost of coal during the year that followed the change was 8 cents per train mile.

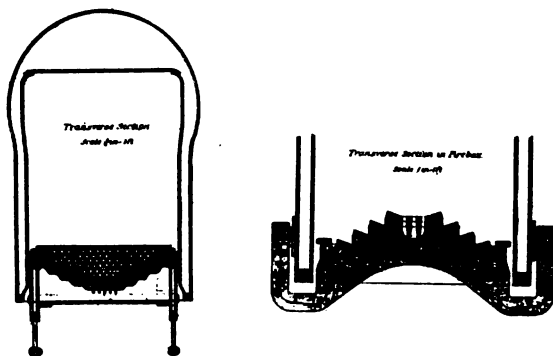

Fig. 177. Jeffrey's Coal Burning Step Grate

The first coal burners had the old wood burning stack with a coarse netting. Next improvement was putting a cover on top with a circular opening 12 inches diameter. Mr. Griggs soon decided that the large wood burning stack necessary for wood burning, even when modified, was not satisfactory, so he designed the diamond stack and it was applied in substantially its present form.

#### Work of American Master Mechanics.

The attitude of American railway master mechanics on the introduction of coal burning appliances was different from that of their compeers, the locomotive superintendents of Europe. The latter were their own engine builders and designers, and upon them devolved the responsibility of introducing the changes required by the progress of the times. By this time the demand for coal burning arose; most American railroad companies had

adopted the practice of depending upon locomotive building firms for their supply of motive power, and these builders were expected to provide the improvements demanded by advances in engineering science or practice. On this account few master mechanics of the United States were designers of coal burning appliances, Griggs, Head, Yates, Millholland, Hayes, Buchanan and Eaton of the Great Western of Canada being notable exceptions.

### Designing Smoke-Preventing Fire Boxes.

In a general way the problem which the coal burning furnace inventors endeavored to work out was supplying to the fire all the

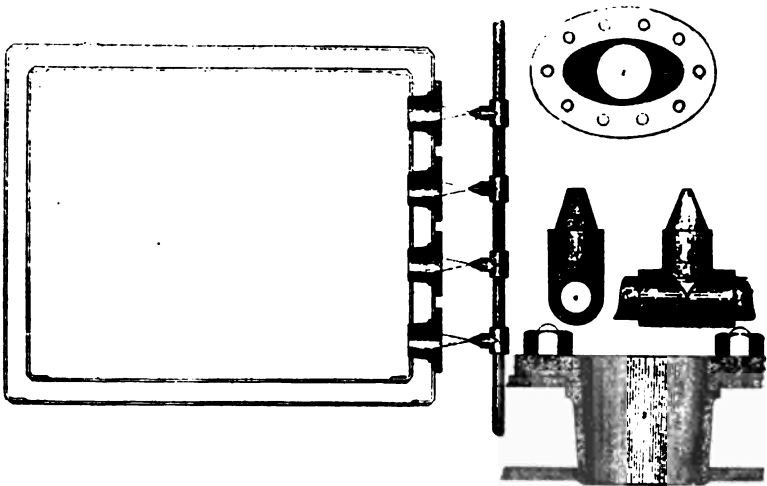

Fig. 178. D. K. Clark's Steam Jets

air necessary for complete combustion, mixing it with the fire gases and maintaining a furnace temperature sufficiently intense to prevent any portion from falling below the igniting temperature. These were conflicting conditions and efforts were made to overcome their difficulties by elaboration of furnace attachments. Water tables and mid feathers were for a time highly popular, but experience demonstrated that they took away so much heat from the gases, that loss of fuel ensued and smoke was caused by part of the fire box becoming chilled below the igniting temperature.

### The Combustion Chamber.

An object of high and persistent hope was the combustion chamber. Nothing seemed more susceptible of demonstration to the

scientific mind than the theory that by prolonging the passage of the heat gases from the grates to the flue openings, increased opportunity must be given for the chemical combination that produces the highest development of heat. To meet this perfecting condition, all sorts and sizes of combustion chambers were devised. The favorite combustion chamber was open in direct connection with the fire box, but others were near the middle of the boiler with large tubes that were not supposed to extinguish the flame intervening between the fire box and chamber. As the combustion

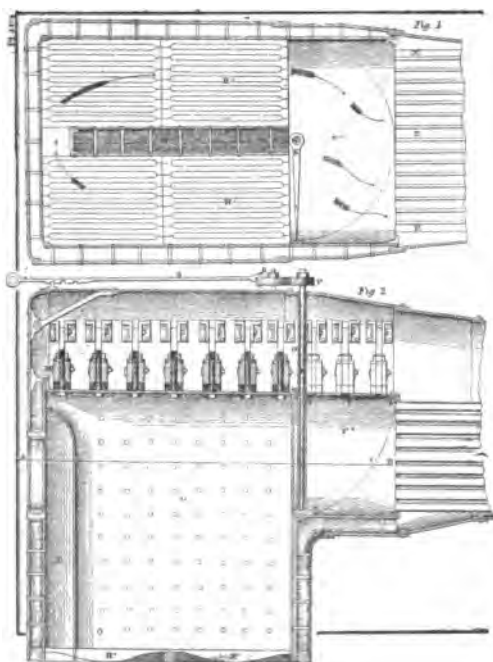

Fig. 179. Head's Fire Box

chamber was the vessel where the final combination of oxygen with the hydro-carbons was to occur, inventors did not fail to provide a direct supply of air at that point. Strange as it may appear, and contrary to nature's laws as read by the ordinary observer, that source of air supply was never opened without reducing the steam generating capacity of the boiler. Those operating locomotives so equipped soon learned that shortness of steam pressure quickly followed admitting air direct to the combustion chamber, so they left the openings in innocuous desuetude,

In spite of all the theories that complete combination of the gases would be promoted by the space provided in a combustion chamber, tube surface was never substituted for that space without producing an improvement in the steaming properties of the boiler.

It seems to me, however, that the development of the twentieth century locomotive, with short wide fire box and enormously long tubes, gives the opportunity for the introduction of a combustion chamber that would increase the efficiency of the boiler. In the old engines the combustion chamber made the tubes too short for efficiently absorbing the heat from the fuel gases. In boilers that now have tubes 20 feet long, or more, four feet could

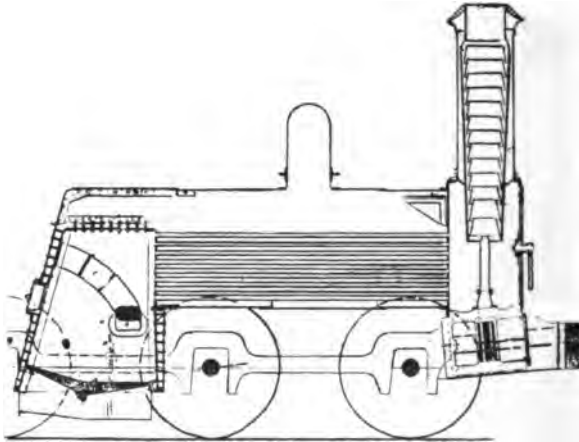

Fig. 180. Eaton's Smoke Consuming Boiler

be cut off them with advantage and converted into a combustion chamber.

#### Workers on the Coal-Burning Problem.

The illustrations which I publish of the leading British and American coal burning locomotives constitute a graphic history of the subject.

I have never seen a drawing or engraving of Grigg's invention, but it possessed no complex features, being a plain brick arch with means for permitting the admission of a limited supply of air above the fire through fire door perforations.

About the time that Griggs introduced the use of the brick arch, cast iron deflectors were tried by Samuel J. Hayes, of the Illinois Central; W. S. Hudson, of the Rogers Locomotive

Works; H. Uhry, of the New Jersey Locomotive Works, and others; but the life of cast iron exposed directly to the heat of a fire box was short lived and the refractory fire brick came gradually into use.

### Means of Admitting Air Above the Fire.

All through the earnest labor attending the efforts to produce a fire box that would burn coal rich in hydro-carbons, without causing a nuisance from smoke, the fire door has been a favorite point for the admission of air and that connected with a baffle plate, designed to project the entering air upon the surface of the fire, has been one of the best combinations ever applied for the prevention of smoke and it is still in very successful use on thousands of locomotive. It is not known who first applied the baffle-plate, hood, or deflector, as it is variously called, but it may be

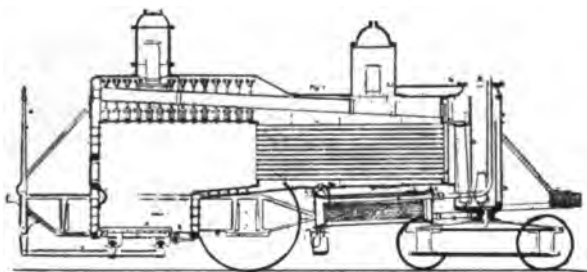

Fig. 181. Rogers' Coal Burning Boiler

accepted as certain that some observing fireman first suggested its use. When a fireman would push the shovel upside down into the fire box, a common practice, to enable him to examine the surface of the fire, he would notice that smoke ceased passing out of the chimney so long as the inverted shovel was injecting air upon the surface of the fire. The man who first reasoned between cause and effect and proposed some sort of permanent scoop on the fire door originated a very valuable invention.

The pioneer coal burning fire box inventors provided a great variety of plans for the admission of air above the fire. One writer on smoke prevention advocated that 4,000 small holes be provided to admit air through the back walls of the fire box and his advice was followed in a modified form. Hollow stay bolts came largely into use and many fire boxes were so profusely perforated that the fiery furnace made a pyrotechnic display as trains rushed through space on dark nights.

### Admitting Air Above the Fire Box.

The condemning difficulty with all arrangements for admitting air above the fire has been want of proper means of regulation. At one time the quantity of air admitted would be so near right that smoke would be prevented, so long as the rank gases were distilling from the coal, but when that ended the amount of air would be too profuse, lowering the temperature of the furnace and wasting fuel to heat a superfluous volume of air. Clark's jet [Fig. 178] already alluded to, was the most successful appliance ever tried for the admission of air above the fire, because the supply could be regulated by a little care on the part of the engineers.

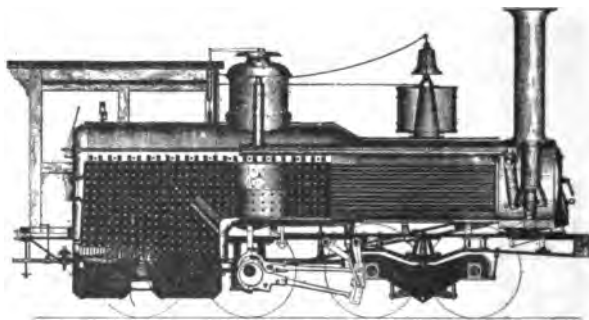

Fig. 182. Baldwin's Coal Burning Boiler

### Head's Fire Box.

A fire box that displayed ingenuity of design was that shown in Fig. 179, patented by S. H. Head, of Boston, in 1859, and applied to engines on the Fitchburg Railroad. As will be seen by the engraving, it had a mid feather cutting the fire box in two longitudinally with independent fire door door grates and ash pan for each side. There was a short combustion chamber with a damper, K, which could be operated to close one side of the fire box. The idea was to close the side of the box when firing was going on, so that the products of combustion had to go around the mid feather. It was a pretty scheme in the estimation of the inventor and gave the fire gases a long journey, but somehow railroad master mechanics generally thought it called for too much manipulating.

### Eaton's Boiler.

Fig. 180 illustrates a coal burning boiler designed by Richard Eaton, of the Great Western Railway of Canada. The fire box

had a water arch projected from near the top of the back sheet and extending downward below the lower row of flues. A notable feature of this boiler was the smoke stack which had a series of flounces intended to regulate the draft. There was also a tubular feed water heater in the smoke box.

### Rogers Coal Burning Boiler.

The boiler illustrated in Fig. 181 was that advocated by the Rogers Locomotive Works for coal burning. Its leading features were a fire box with shaking grates and a rather long combustion chamber. The grates were the invention of Hudson & Allen and that with the other parts of the combination were highly popular for a few years. An engine thus equipped belonging to the Great

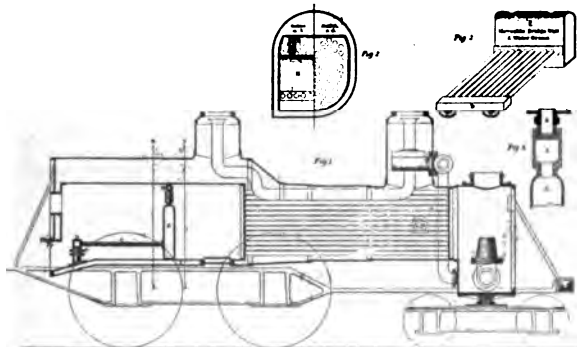

Fig. 183. Norris' Coal Burning Boiler

Western Railroad of Illinois had one set of grates in constant use for three years. A peculiar feature of these engines was the tubular feed water heater shown in the engraving. The shaking grates was the only element in this pioneer coal burning boiler that became a permanent attachment.

### Baldwin's Coal Burning Boiler.

The coal burning boiler made by the Baldwin Locomotive Works, shown in Fig. 182, had an unusually large fire box, a cast iron deflector at the opening of the combustion chamber which contained what the builders called a transverse diaphragm provided for the purpose of thoroughly mixing the gases while maintaining the igniting temperature.

In this connection it is well to mention that M. W. Baldwin was one of the first makers of locomotive boilers to take the stan<sup>1</sup>

that with careful firing no extra attachments were necessary to make an ordinary fire box burn bituminous coal satisfactorily. The transverse diaphragm in the combustion chamber of his coal burning boiler would have been difficult to maintain and the annoyance resulting would probably help Mr. Baldwin to the conviction that special smoke preventing appliances were a superfluity.

### Norris Coal Burning Boiler.

A coal burning boiler patented by Septimus Norris and built for locomotives by William Norris & Son had several very curious features. The fire box was unusually long and had a movable bridge wall and water grate. An opening at the back end of the grates was covered by a movable plate which acted as a dump grate. The length of fire box proper and of the combustion

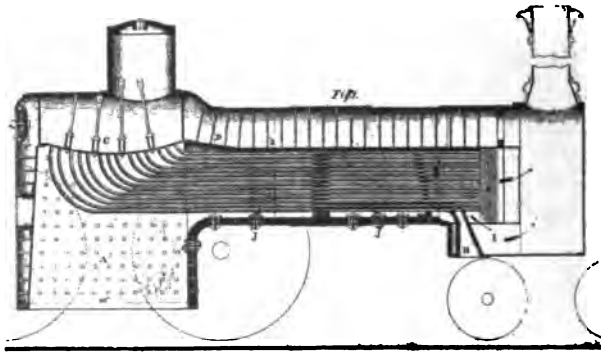

Fig. 184. Dimpfel's Coal Burning Boiler

chamber was regulated by the position of the water bridge, which could be advanced or drawn back by lengthening or shortening the water grate tubes. The whole arrangement will be readily understood by an examination of Fig. 183.

### Dimpfel Water Tube Boiler.

Although locomotive builders and master mechanics made some effort in the designing of coal burning boilers, those that became best known in the United States during the early days of coal burning were patented boilers pushed into use by proprietary interests. Among the best known of these was the Dimpfel water tube boiler, shown in Fig. 184. This boiler was used to a considerable extent on the Philadelphia, Wilmington &



Delaware Railroad, when Mr. S. M. Felton was president. He took a very warm interest in smoke preventing boilers and considered the Dimpfel designed on sound scientific principles.

Engines with the Dimpfel boiler were afterwards made a limited success on the road where they had President Felton's good will, and they did fairly well on other railroads, the persistence and energy of the patentee having helped their operation during the period of first trials, when careful nursing often prevented failure. But when the water tubes burned or wore out, most of the boilers were converted to the ordinary gas tubular type and performed the work of steam generation just as well as when they had the water tubes.

While designers of locomotive boilers kept insisting that a long flameway was essential for the co-mingling of the fuel gases to insure fairly economical result, the Dimpfel seemed an ideal

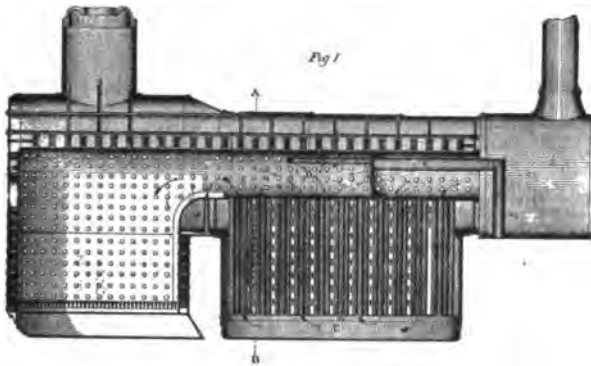

Fig. 185. Boardman's Boiler

boiler, because the whole length of the tubes formed a combustion chamber. This long flameway requirement was insisted on because it was necessary with stationary and marine boilers of natural draft. It took years of experience to demonstrate that the violent blast of a locomotive mixes the fuel gases almost the instant they come together.

### The Boardman Coal Burning Boiler.

Another patented boiler which obtained a brief popularity on a few railroads in the United States, was the Boardman [Fig. 185]. In this boiler a large **U** shaped flue extended from the fire box directly through the smoke box and having a plate iron partition secured across the flue at about two-thirds of its length from the

fire box. A series of vertical tubes descended from the flat bottom of the flue to an ash pan below; but by the interposition of the partition mentioned, the fire gases went down through but about two-thirds of the total number of tubes and rose again through the remainder, passing thence into the smoke box. A pipe extended from the bottom of the smoke box back into the the combustion chamber, as shown, for the purpose of aiding combustion with an additional supply of air. The boiler had flat sides which were stayed together.

### Phleger's Coal Burning Boiler.

The Phleger boiler [Fig. 186] resembled the Septimus Norris, only a little more complicated. It had a hanging bridge, water wall and water grates, besides other curiosities. The Norris people supplied these boilers to several railroads perhaps through fellow feeling towards the patentee. The barrel of this boiler, 3 feet 10½ inches in diameter, was packed full of tubes, 230 of them, 2

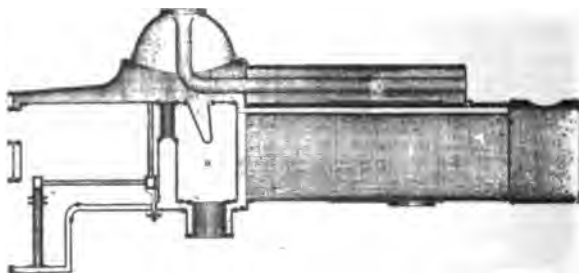

Fig. 186 Phleger's Boiler

inches diameter, 11 feet long, steam space being provided in a steam chamber of the modern steam drum order. This boiler gave an early test of excessive heating surface, the fire box and combustion chamber having been 11 feet long, but its performance did not encourage railroad people to perpetuate the type.

The Pennsylvania Railroad Company purchased seven locomotives with Phleger boilers and ran them until rebuilding was necessary, when each one was changed to suit the taste of the mechanical engineers of the time.

### Chain Grate and Automatic Stoker.

A great many of what might be called minor patents were secured on coal burning and smoke consuming furnaces between

1850 and 1870, but few of them went further than the Patent Office records. Some of them, however, attained passing newspaper celebrity and then disappeared forever. Among those was a movable chain grate arrangement which was applied to several locomotives about New York City in 1850, and was partly an automatic stoker. The New York Evening Post predicted that the invention would effectually end the smoke nuisance, and said: "It consists of what may be called an endless chain of bars forming the bottom of the furnace on which the live coal blazes. The chain moves very slowly, not more than one inch a minute. At the end of the furnace the chain moves round and goes back beneath. The apparatus is fixed on a car and can be run into place on rails so that the whole bottom of the furnace can be dragged out, giving every facility for cleaning and renovating. The coal is laid in a hopper at the door and the supply of coal regulated by a sluice slide."

Like all the other smoke consuming furnaces, this one soon disappeared, but it had automatic stoker features which were afterwards successfully applied to stationary boilers.

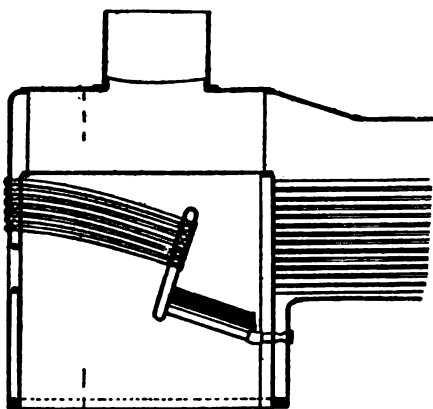

Fig. 187. McQueen's Boiler. Patented by  
Walter McQueen of Schenectady  
Locomotive Works

# Spark Arresters and Draft Appliances

---

## CHAPTER XXV.

---

An alarming ordeal was undergone by a party of pleasure seekers who had the honor of riding on the first train of the Mohawk & Hudson Railroad. A gala day was observed on August 9, 1831, to celebrate the opening of the new railroad and none but politicians and distinguished people obtained permission to ride on the train that was to inaugurate a new departure in land transportation. The cars, which were old stage

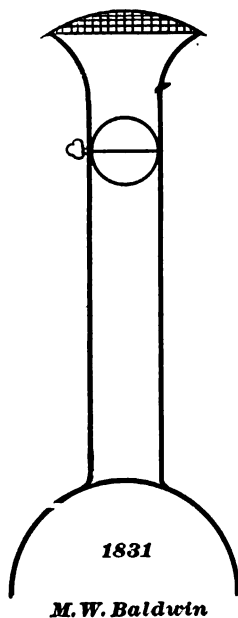

Fig. 188

coach bodies, were loaded with the distinguished people inside and out. When the train started, the sharp exhaust of the locomotive threw out a stream of burning sparks from the pine wood burned, that descended like a shower of red hot hail upon the passengers, passing into every crevice of their gar-

ments, roasting their ears, necks and other exposed parts and setting fire to the clothing of many of the distinguished people.

That trip, and many other similar experiences, abundantly proved that something must be done to prevent locomotives from throwing sparks. The invention of spark arresters was thus commenced early in the railroad era, and it has not entirely ceased on this day of grace, March, 1907.

The evils of spark throwing had been recognized before the Mohawk & Hudson pleasure seekers had received their baptism of fire, for early that year Mr. Baldwin had applied the form

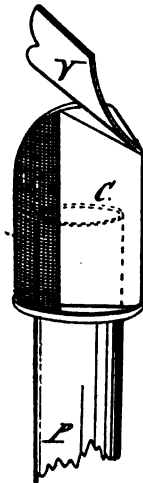

Fig. 189. Espy's Patent

of spark arrester shown in Fig. 188, which may be fairly termed the prototype of the smoke stack spark arrester.

### Patented Spark Arresters.

Shortly after that date the patented spark arrester began to appear, the first one having been secured by James P. Espy and illustrated in Fig. 189. It consisted of a cap which was fitted to turn on the top of the stack and was pointed, or inclined, on its front side and kept to the wind by a vane. The opening on the rear side of the cap was covered by a sheet of wire gauze. This stack was tried on the Philadelphia & Germantown Railroad and on some steamboats, but it soon disappeared forever.

### Classes of Spark Arresters.

Starting with the original Baldwin spark arrester of 1831 as a basis, the numerous proposed designs, as well as those actually put in use, have been worked out on two general lines; first, appliances located in the stack, and, second, those located in the smoke box and used with an open stack. Of the multitude of these, of both classes, that have been produced, but few are worth examination, fewer still have gone into service at all, and scarcely any now survive except the diamond stack and the various detailed forms of smoke-box deflector and netting.

### Dripps Smoke Stack.

The development of the 1831 or the stack type of spark arrester may be briefly traced, as it embodies only two steps of

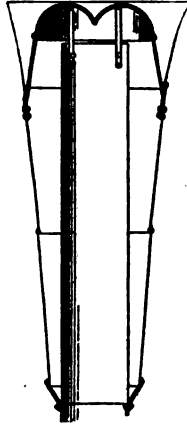

Fig. 190. Dripps Smoke Stack Applied to Locomotive John Bull in 1831

improvement which remain to any substantial extent in present practice; first, the addition of the central cone, and, second, the change of the casing to the diamond form. The deflecting cone was doubtless designed by Isaac Dripps, on the Camden & Amboy Railroad in 1833. This design, which is illustrated in Fig. 190 and was not patented, embodies all the elements of the so-called "balloon" or "bonnet" stack which, at a much later date and for a considerable period was almost universally used on American railroads.

Many of the improved spark arresting smoke stacks which were Dripps design, with a few useless features added, were

patented and drew large sums for royalty from American railroad companies.

The second stage of development and popular form of spark arrester of this type was the diamond stack first brought out by George S. Griggs and illustrated on page 200.

### Matthew's Spark Arrester.

When the notable run already described was made on the Mohawk & Hudson Railroad, David Matthew was the engineer. Matthew had worked in the West Point Foundry, New York, and helped on the construction of several of the first locomotives built in this country. He became master mechanic of the Mohawk & Hudson Railroad and it is not surprising to find that he devoted much attention to spark arresters.

In a pamphlet, published in 1859, Matthew gives engravings and descriptions of his spark preventing inventions. In a note addressed to railroad officers he says: "Have made many improvements gratuitously for the advancement of railroads; for which, though morally entitled, I have never yet, and do not expect to receive any reward. Among these may be enumerated the snow plow, steam pipes for heating water in tenders and keeping pumps from freezing, the arrangement of the semi-circular or circular engine house with turntable, the wheel press for putting on and taking off wheels, the hand car and other improvements."

The spark arresters shown in Plate 1 give particulars of Matthew's labors in developing the spark arrester. His design marked 9 was developed into the arrangement illustrated in plate 4 through which it was intended to convey the sparks back to the fire box. The idea was not original with Matthew, for in 1838 a patent had been granted to W. S. Montgomery for a deflector and pipe to be employed in arresting the sparks and carrying them back to the ashpan. Many succeeding attempts were made to convey the sparks back to the fire box, while others of a similar character aimed to convey smoke and sparks over the train, but they all ended in failure. Attempts of this kind have been made since the twentieth century began.

The stack marked 1836 was furnished by Mr. Baldwin and was presumably his invention.

The stack marked 8, of date 1841, was used considerably on the lines now forming part of the New York Central System.

**DAVID MATTHEW'S COURSE OF EXPERIMENTS.**

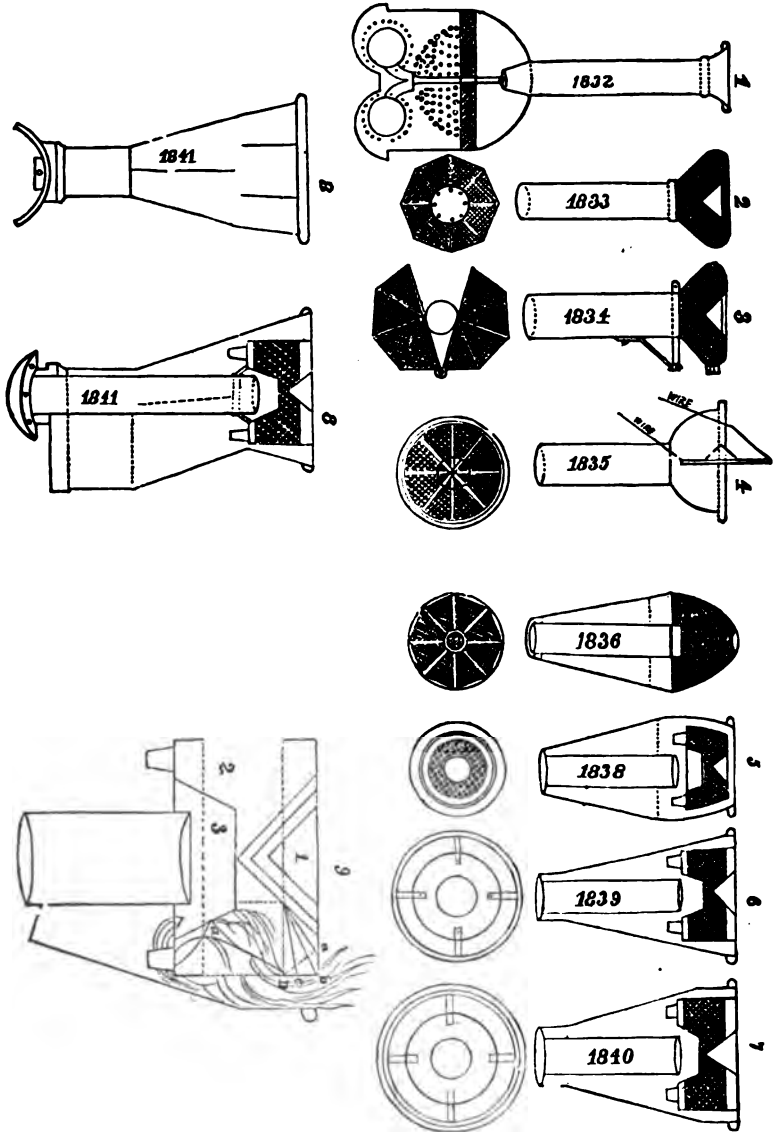

Plate I.



### Labors of Master Mechanics' Association.

The American Railway Master Mechanics' Association have devoted extraordinary attention to spark arresters almost since the association was formed in 1868 and their committees labored hard to find a practical route between too conflicting conditions. In the dry climate of North America, with inflammable material lining every right of way, it was found imperative to restrain the free movement of sparks from the fire box through the tubes and smoke box into the air. Every obstruction put between the exhaust nozzle and the atmosphere, restricted the flow of draft so that increased velocity of the exhaust steam had to be resorted to so that steam could be generated in sufficient volume to perform the work required to be done. The history of spark arresting has been, obstructing the escape of the fuel gases on the one side and of increasing their velocity on the other. The workers in this line always had Scylla on the one side and Charybdis on the other.

### Henry B. Stone's Report.

A most exhaustive report on spark arresters was made by Henry B. Stone and published in the Sixteenth Report of the Master Mechanics' Association. It is very elaborately illustrated with a multitude of spark arresters used or patented. In a masterly analysis Mr. Stone arranges the different forms of spark arresters into four groups with exhibits illustrating the inventions as follows:

Exhibits 1 to 37—To illustrate different forms and combinations of netting and cones.

Exhibits 38 to 87—To illustrate extinguishing and pulverizing sparks by centrifugal force, by plunging into water, and by jets of air and steam.

Exhibits 87 to 107—To illustrate the conveyance of sparks after having been arrested.

Exhibits 109 to 115—To illustrate extended smoke boxes with and without screens and deflectors.

It is impracticable for me to reproduce the vast array of illustrations to Mr. Stone's report, but I shall give enough examples to display each line of invention.

Plate 2 shows a variety of stacks that have been enlarged and loaded with obstructions to the escape of sparks, some of them having "treasuries," as they were called, for retaining the

sparks until they could be drawn off at convenient points after the engine stopped.

Plate 3 has four figures illustrating methods that were strongly recommended as an effectual preventative of spark throwing. In these the sparks were caught in the stack and, after being pulverized by centrifugal force, were conveyed to a water tank where they were quenched—drowned out of all evil doing.

Plate 4 illustrates appliances for conveying the arrested



Henry B. Stone, who computed Valuable  
Report on Spark Arresters

sparks to a place of safety, generally to the fire box where they belonged.

Plate 5 illustrates the growth of the extension smoke box, all of them dating after 1880. Twenty years earlier John Thompson, of Boston, introduced an extension smoke box which led several New England railroads to use that form of spark arrester, but it lacked deflection plates and was by no means satisfactory until improved. The deflection plate arrangement was used by Isaac Dripps in 1832, as can be seen on several of his boilers illustrated, and it was applied in various shapes by others, as in Fig. 193, which was patented in 1859. In that arrangement the exhaust pipe is surrounded by a netting

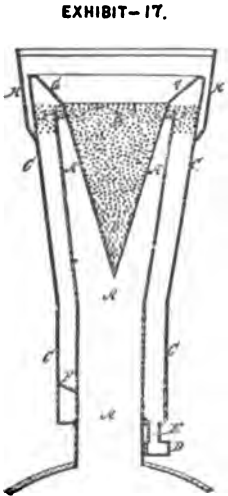

A. Keagy—Patented April 29, 1842.

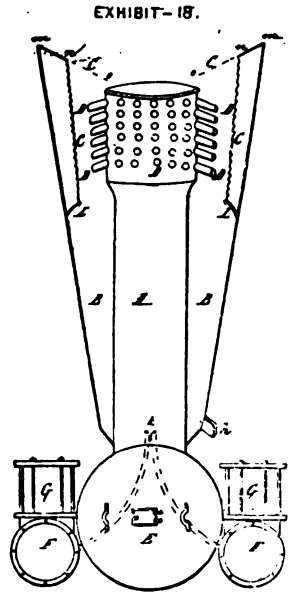

J. Eckler—Patented Oct. 7, 1842.

EXHIBIT-20.

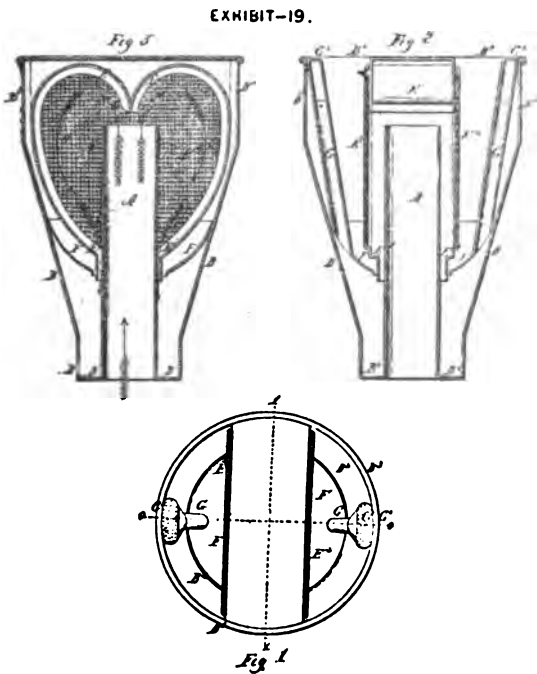

S. Sweet, Jr.—Patented August 26, 1846.

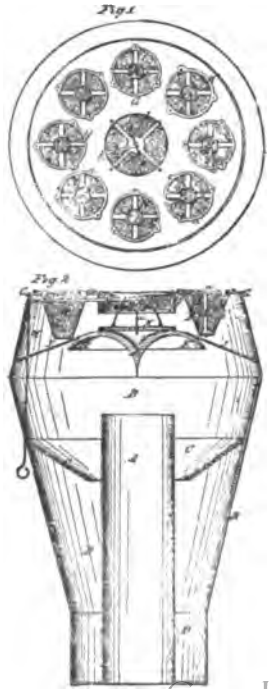

S. Sweet—Pat. Oct. 25, 1851.

formed in a reversed cone, and would no doubt act as a satisfactory spark arrester. The conical netting was several times an element on patented spark arresters.

A curious thing about some elements of spark arresting appliances was that they were patented repeatedly and railroad companies paid royalties for the privilege of using spark arresters that did not possess a solitary "new and useful" feature which is supposed to be necessary to the granting of a patent.

### Proprietary Smoke Stacks.

At one time nearly every railroad of any importance had a smoke stack patented by some official who did not fail to see that his smoke stack was kept in use and the royalties regularly paid. In many cases the patent smoke stack was cause of great annoyance to the men responsible for the successful operating of locomotives, especially to engineers and firemen as the draft was so badly obstructed that free steaming was often out of the question. There was a huge, ungainly stack that was very common on some Western roads which the trainmen called the "ice freezer." When the engine so equipped jumped the track, through a short-switched rail or any other cause, that smoke stack never failed to topple to the ground, bowling over switchmen or others who might be in its way. Not a few men lost their lives by this extraordinary projectile.

### Upside Down to Improve.

I knew of a case where a master mechanic patented a smoke stack with the expectation that it would produce revenue, and much interest was manifested on the result of its first trial. It was applied to an engine run by Tony Shultz, a droll German, whose report upon the stack's behavior might be relied upon. Tony was on a local run so that he went to Junction one day and returned the next. On the evening of his arrival from the round trip, not a few interested persons were waiting when the engine arrived at the turn table.

"Well, Tony, how did she go?" inquired Master Mechanic Jones. "Vell, Meister Jones," replied Tony, "she vent all de vay rount, but dere is von leetle change vould improve dot schtach. If you vould durn him up side down he do petter, for all de draft goes down dot schtach."

### Diamond Stack and Extension Fronts Hold the Fort.

It took a long time but the time came by degrees when the diamond stack and some form of extension smoke box monopolized the spark arresting functions, except on railroads where wood was still burned. The American Railway Master Mechanics Association performed valuable services to railroad companies by the ably conducted investigations their committees carried on, to demonstrate the forms of spark arresters that were most efficient while offering the least possible obstruction to the escape of steam and of the fuel gases.

Extension smoke boxes had been tried about 1860 with little promise of success, but the open smoke stack appealed to many of the ablest motive power officials, as the proper manner for

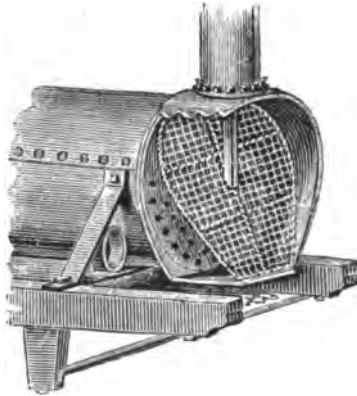

Fig. 191. McIlvain's Smokebox Spark Arrester, 1833

passing the exhaust steam and product of combustion into the air. It had many points in its favor. Even if more sparks passed out than cones, nettings, and stack obstructions permitted, when escaping through an open stack they were thrown high into the air and were not so dangerous after alighting as sparks that had made a lower flight. Then the open stack permitted the smoke to ascend into the air preventing the trailing action over trains which was so disagreeable to passengers.

### Groesbeck's Spark Extinguisher.

Shortly after the use of the extension smoke box became fashionable a variety of improvements were introduced in the

EXHIBIT-52.

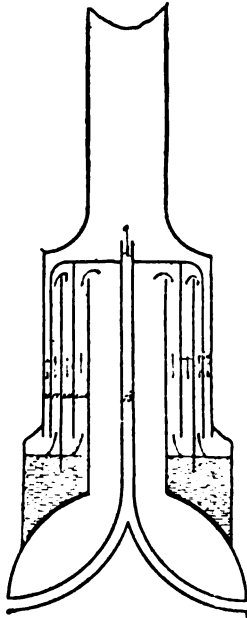

J. A. Roebling—Pat. Feb. 16, 1843.

EXHIBIT-52.

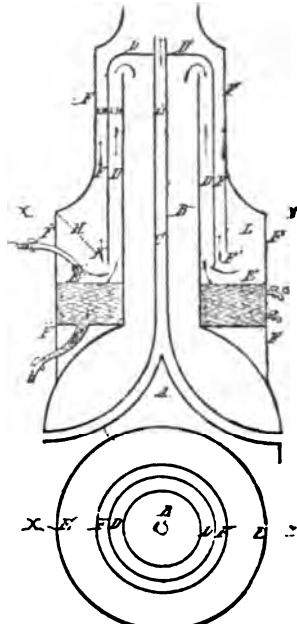

The same.

EXHIBIT-53.

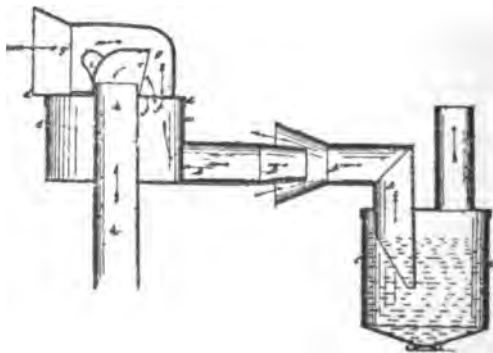
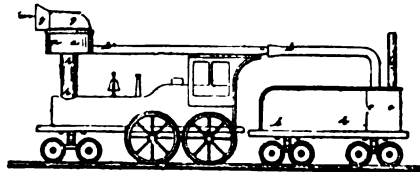

C. B. Keys—Patented June 19, 1866.

Plate III.

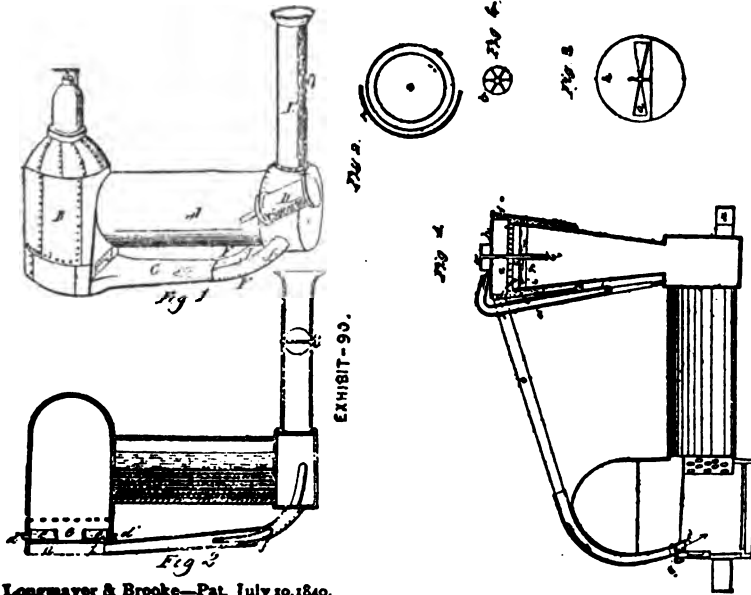

Longmayer & Brooke—Pat. July 10, 1840.

J. Montgomery—Patented January, 1847.

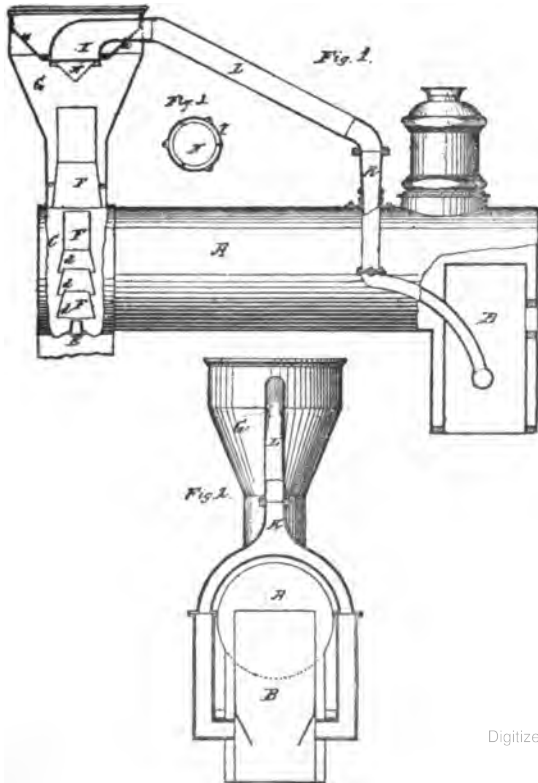

G. H. Griggs—Patented September 10, 1872.

shape of water tanks carried under the smoke box for the purpose of extinguishing the sparks. The best of these was patented by Groesbeck, Stirling and Ball, in 1883. Groesbeck was a retired banker who made inventing spark arresters a hobby. I have ridden in the cab of an engine, equipped with this spark extinguisher, pulling a heavy freight train and working very hard. It was at night and not a spark was to be seen issuing from the stack.

These considerations gave the extension front end popularity and it forced its way gradually into favor. By 1890 extension front ends were becoming so common and the draft appliances so varied that agitation began to be made in favor of some standard form of combination that would be suitable for all locomotives.

#### **Quagle's Report on Exhaust Nozzles, Etc.**

In 1894 a most exhaustive report was made by a committee of which Robert Quagle, of the Chicago Northwestern was chairman. They made a series of tests on a special testing plant provided by the Chicago Northwestern Railway. Work was continued by that committee for three years and the final report submitted in 1896 covers 86 pages of the proceedings. The subject was Exhaust Nozzles and Steam Passages, but it covered everything relating to draft appliances.

The conclusions arrive at as to what constituted the best arrangement of draft appliances seemed to be as decisive as any investigation of the kind can be, but the Association did not accept it as final.

In 1902 a new committee, of which H. H. Vaughan, of the Lake Shore & Michigan Southern, was chairman, was appointed to report on Locomotive Front Ends. This committee worked for three years and enlisted the co-operation of Professor Goss, of Purdue University, who carried on tests and experiments on the locomotive testing plant belonging to that institution. A report was made in 1903 but the work was continued.

The final report was made to the convention in 1906, and for the present may be regarded as final. The following is a summary of that report:

#### **Outside Stacks.**

The tests of outside stack involved two different heights, namely, 29 inches and 47 inches. The 29-inch height only is



EXHIBIT-115.

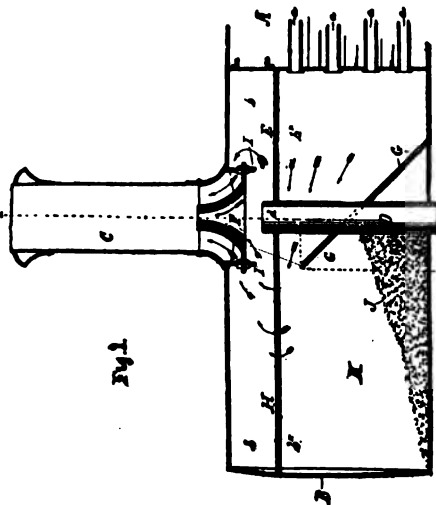

Fig. 1

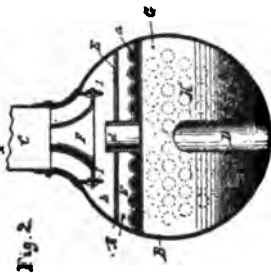

Fig. 2

EXHIBIT-114.

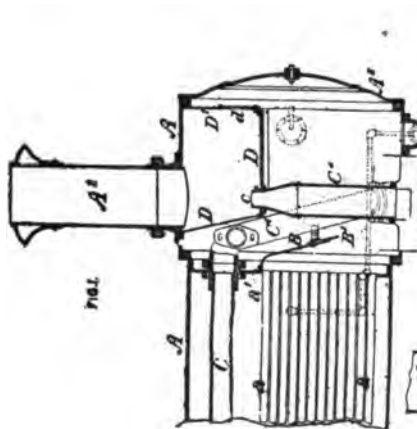

Fig. 1

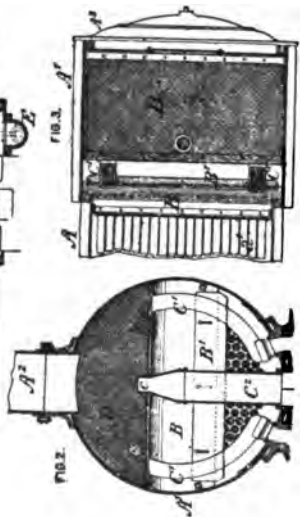

Fig. 2

H. Millholland—Patented January 30, 1883.

EXHIBIT-113.

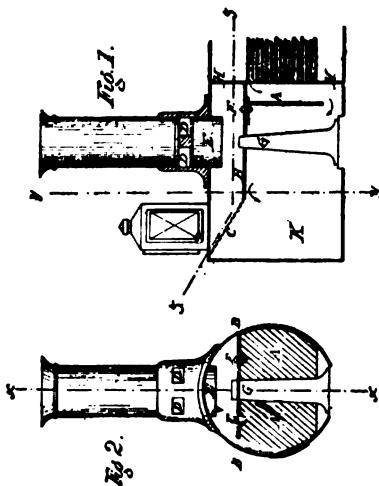

Fig. 1

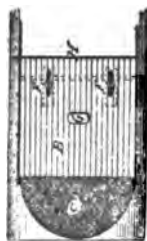

Fig. 2

R. Hill—Patented July 11, 1882.

Kowalsky, Gunther & McClehan—Patented Sept. 20, 1881.

Plate V

practicable for road conditions upon the locomotive under test. Stacks of each of these heights were supplied in diameters ranging from 15 inches to 21 inches by 2-inch steps and as the work proceeded it seemed desirable to extend the range with the result that in the 29-inch height, stacks of 23 inches and 25 inches diameter respectively were added to the series. In these tests no draft pipes or netting were employed in the front end; the diaphragm and exhaust pipe were the only details present. Under these conditions, with a 29-inch height, the



Robert Quayle, Who Conducted Exhaustive Experiments with Draft Appliances

best diameter was found to be 23 inches, though this was not much better than that of 21 inches. With a 47-inch height the best diameter is 21 inches. The point which is proven is that, assuming a plain outside stack 29 inches high to be used, its diameter for the best results is 23 inches.

#### **Results Obtained from a Large Locomotive.**

Among the more important conclusions drawn from the tests of 1903, the following are of especial interest in connection with the present discussion:

1. That for a tapered stack, the diameter for best results does not change with changes in height.

2. That the diameter of stack is somewhat affected by the height of the exhaust tip, the diameter for the best results being greater as the nozzle tip is lowered.

3. That, calling  $d$  the diameter of the stack at its smallest part, and  $D$  the diameter of the front end, the relation between the diameter of stack and front end when the exhaust tip is at the center of the boiler is

$$d = .25D.$$

4. That the diameter of stack must, for best results, be increased .16 inch for each inch that the exhaust tip is below the

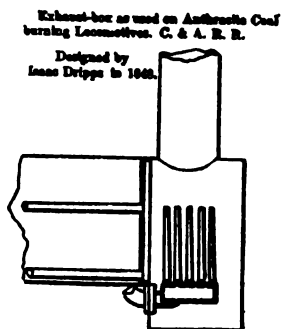

Fig. 192

center line of the boiler; that is calling  $h$  the distance between the center line and the tip,

$$d = .25D + .16h.$$

5. That a variation of an inch or less from the diameters given by the equation will produce no unfavorable results.

As to the necessity for varying the diameter with the height of stack, the work of the past year is far less elaborate than that of 1903, but two heights of stack having been employed, namely, those of 29 inches and 47 inches respectively. Comparing draft values obtained from stack of each of these heights under a uniform back pressure of 3-5 pounds it appears that the best diameter for the 29-inch stack is 23 inches. The best results from the 47-inch stack were obtained by use of the largest diameter experimented upon (21 inches). Curves plotted through the several points show this diameter to approach that for the maximum draft, but it does not equal it. The in-

dication is that if a diameter of 23 inches had been employed it would have been found right for the 47-inch height as well as for the 29-inch height. So far as outside stacks are concerned, therefore, the diameter does not need to be varied when the height is changed.

As to the effect upon the proportion of stack resulting from changes in the height of the exhaust tip, it must be noted that the work has involved one height of tip only and hence gives no information upon this question. The validity of the conclusion already stated, however, has never been called in question and it may be assumed to stand.

Concerning the actual size of the stack for best results, the work points to the desirability of using diameters which are somewhat larger than those given by the equation.

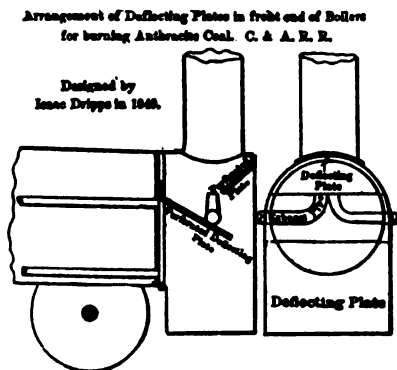

$$d = .25 D + 16h.$$

which when applied to the New York Central locomotive experimented upon gives

$$d = .25 \times 74 + .16 \times 12.5 = 18.5 + 20 = 20.5,$$

whereas, with a stack 29 inches high the best results were actually obtained when the diameter was 23 inches. The difference of 2.5 inches is not great, especially in view of the fact that it has been distinctly noted that variation of an inch or even more is not important. The difference is to be accounted for also by the fact that in reviewing the results of 1903 there was a common feeling on the part of the members of the advisory committee that the experiments pointed to dimensions which, for service conditions, were excessive. Because of this view, the equation was framed as a

conservative expression of the experimental results. The data obtained during the present year might, for like reasons, be similarly treated, in which case the discrepancy of 2.5 inches would be diminished or even be eliminated. Since, therefore, the only element of doubt concerning the results of 1903 has found expression in beliefs that they gave diameters which were too large, it is the feeling of your committee that the work of the present year may be accepted as a full confirmation of the earlier work.



Professor Goss, of Purdue University, Who Supervised Experiments With Front Ends of Locomotives

Having shown the value of the work of the present year in confirming the conclusions of 1903, it remains to consider those phases of the present year's work which are to be regarded as extending beyond the scope of the earlier investigations; the effect of which necessarily diminishes the importance of that which has preceded. It will be shown that, however well the plain outside stack may be proportioned, the demands of service require it to give way to a more highly articulated device.

### Inside Stacks.

The experiments included inside stacks of four different diameters ranging from 15 inches to 21 inches, a constant outside height of 29 inches and a penetration into the smoke box of 12 inches, 24 inches and 36 inches, respectively. The best proportions of this form of stack is such that its diameter is 21 inches and its penetration (P) into the smoke box is 12 inches. Results of nearly the same value were, however, obtained with stacks of smaller diameter having greater penetration. This may well be seen by reviewing the draft values obtained in return for a back pressure of 3.5 pounds. Thus, 21 inches diameter, 12 inches penetration gave a draft of 4.71; 19 inches diameter, 24 inches penetration gave a draft of 4.55, and 17 inches diameter, 26 inches penetration gave a draft of 4.32. From values thus presented it appears that as the degree of penetration increases the diameter of stack should be reduced. The effect is, in fact, of the same nature and degree as that which results from raising the exhaust tip. It is noteworthy also that these values for the plain inside stack are not materially better than those for the plain outside stack, a fact which was formulated as a conclusion resulting from the work of 1903.

### Inside Stack with False Top.

It had been planned to fit the front end with three different false tops located at 12 inches, 24 inches and 36 inches, respectively, from the top of smoke box, but the presence of the steam pipes made it difficult to fit the 12-in. top, and as a consequence only the 24-in. and 36-in. drops were experimented upon. In each case stacks of different diameters were used, the outside height being always 29 inches. The best results were obtained with a stack 17 inches in diameter having a penetration of 24 inches. In all cases with the false top the 17-in. stacks gave the best results. A comparison of these results with those quoted for plain outside stack and for plain inside stack show material improvement in draft values.

### Substitutes for False Top.

The false top necessarily interferes with free access into the front end, which fact makes it desirable that a way be found in which to secure the results derived from it by means which are more simple. It was suggested that experiments be made to determine the effect upon the plain inside stack of an annular ring or flange which might be considered as representing a portion of

the false top. Responding to this suggestion, rings of two diameters were used on 17-in. and 19-in. stacks having a penetration of 24 inches. It was found that the proportions gave substantially the same results as those obtained with the best arrangement of false top. Believing that the results thus obtained pointed to the desirability of having a broader curve at the base of the stack and that when the proper proportions were understood the best results would be obtained from such a curved surface, the 17-in. stack was fitted with a bell to which, for purposes of experimentation, flanges of various widths were afterward added, with the result that those proportions proved most satisfactory. The best draft with the false top was 5.06; with the ring, 5.05, and with the bell, 4.98—that is, these three arrangements are practically on an equality. No other arrangements were experimented upon which gave higher draft values than these.



Fig. 194. To Drown Sparks]

### Single Draft Pipes.

Draft pipes of various diameters, adjusted to many different vertical positions, were tested in connection with plain stacks of the several diameters available. The elaboration of this phase of the work was very extensive. It was found that for the best results the presence of a draft pipe requires a smaller stack than would be used without it, but, that no possible combination of single draft pipe and stack could be found which gave a better draft than could be obtained by the use of a properly proportioned stack without the draft pipe. While the presence of a draft pipe will improve the draft when the stack is small, it will not do so when the stack is sufficiently large to serve without it.

### Double Draft Pipes.

Double draft pipes of various diameters and lengths, and having many different positions within the front ends, all in combina-

tion with stacks of different diameters, were included in the experiments, with results which justify a conclusion similar to that reached with reference to single draft pipes. Double draft pipes make a small stack workable. They can not serve to give a draft equal to that which may be obtained without them, provided the plain stack is suitably proportioned.

### The Length of Front End.

The experiments involving different lengths of front end only appear to be inconclusive. The range of these experiments included the length of the front end normal to the locomotive,

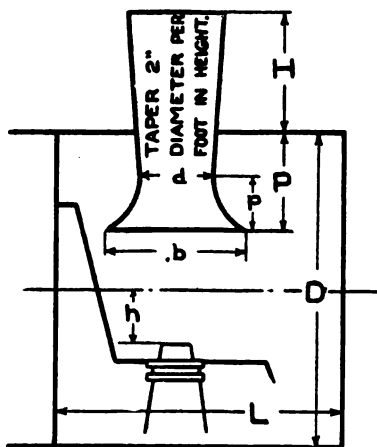

Fig. 195. Railway Master Mechanic's Standard Front End

which is 65.75 inches, with successive reductions therefrom of  $4\frac{1}{2}$  inches,  $8\frac{7}{16}$  inches and 20 inches, respectively, obtained in each case by fitting in a false front. The fitting was well done, the work being made practically tight, notwithstanding which fact it was found that the longest and shortest ends experimented with gave practically identical results, while the lengths between these limits gave results which were somewhat inferior. The peculiar character of the results as first obtained led to a complete duplication of the work after a considerable interval had elapsed, with results which were identical with those first obtained. So far as the experimental results give a solution of this problem, they point to a length of 66 inches or 46 inches as equally satisfactory, and suggest that intermediate lengths are to be avoided.



**Suggestion as to a Standard Front End.**

is presented as Fig. 195, which, with the following equations referring thereto, may be accepted as a summary of the conclusions to be drawn from all experiments made.



J. Snowden Bell, Engineer and Patent Attorney, Who Gave Valuable Aid in Preparing This Chapter

For best results, make  $H$  and  $h$  as great as practicable.

Also make

$$d = .21 D + .16h.$$

$$b = 2d \text{ or } .5D.$$

$$P = .32D.$$

$$p = .22D.$$

$$L = (\text{not well established}).$$

$$= .9D, \text{ but not of intermediate values.}$$

While the drawing is a simple one, to be put forth as a result of so elaborate a series of experiments, it goes without saying that the latter have been valuable quite as much for the things they prove useless as for the proportions of details which they serve to define. For example, it will be seen that the suggested standard

does not include draft pipes, and that it includes a stack of comparatively large diameter having a bell at the lower end of dimensions quite beyond those now common in American practice.

I wish to acknowledge valuable work received from Mr. J. Snowden Bell in preparing this chapter. Mr. Bell also wrote part of chapter.



H. H. Vaughan, Assistant to Vice-President Canadian  
Pacific Railroad, Chairman of American Railway  
Master Mechanics Association Committee  
on Front Ends

# Development of Valves and Valve Motion

## CHAPTER XXVI.

### Imagined Mysteries.

We do not know of any subject that excites so much interest among the rank and file of railroad mechanical men as valve motion. There is certainly no other subject which excites so much discussion, and no one which leaves the disputants so little edified after they have wrangled for hours about details of construction or design that cannot be settled by ordinary reasoning or research. There is a tendency among many people to assume that there is something about the mechanism that actuates the valves which is beyond the ordinary understanding



Fig. 196. Lustral Vase

and that certain experts have a monopoly of the exact knowledge concerning valves and valve motion. This belief is not well founded. Any man of ordinary intelligence, who will devote careful attention to what functions a valve motion performs and carefully note what the results are, will soon become as well informed on the subject as any of the so-called experts.

The history of steam engine valves and valve motion is a

curious study and brings the investigator in touch with a world of high hopes reposed on a design or appliance that promised to bring fame and fortune to the inventor, and too often ended in bitter disappointment, sometimes in financial ruin. Inventors have too often misunderstood what the true functions of an engine valve are, and how far the mechanism that drives the valve influences the distribution of steam.

### Simplest Form of Valves.

In its most elementary form a valve is a device for opening and closing a hole, the most primitive valve having been a

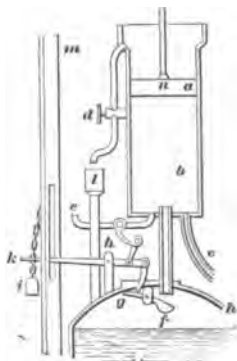

Fig. 197 Newcomen Engine, Showing Flat Admission Valve

door. Ancient temples had self-closing doors, and they were called valves.

The first appliance, now regarded as a valve, performing the functions of opening and closing an aperture, was used on the bellows. That implement must have been employed by the person who first smelted metal, so this form of valve is a very ancient device.

Among the discoveries of Egyptian monuments, figures were found in a tomb at Thebes which bears the name of Thothmes III, one of the Pharaohs, who was contemporary with Moses. These figures illustrate blacksmiths at work, using bellows provided with self-acting valves.

In a fire engine described by Hero of Alexandria in his treatise on mechanism known as the "Spiritalia," two metallic pistons are used, and spindle valves with guards to prevent the



Watt employed a variety of valves for controlling the steam passages, the poppet, a disk with short stem, having been his favorite. Spindle disk valves and slide valves were also used to a considerable extent.

The first attempt to make a successful peripatetic steam moved carriage was by Cugnot, a French engineer, who in 1771 made a steam carriage intended for military purposes, now preserved in the Conservatoire des Arts et Metiers, Paris. It is a single acting, double cylinder engine, the steam distribution being regulated by a four-way cock.

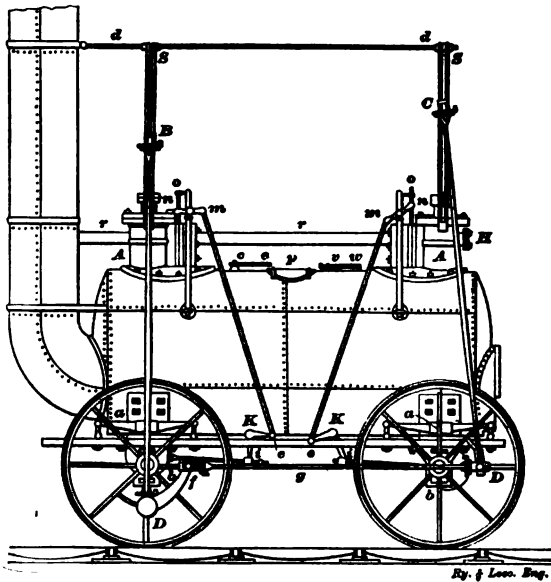

Fig. 199. First Use of An Eccentric On Locomotives

### Murdoch's Experiments on Locomotion:

Next in order among the inventors who tried to apply steam to locomotion was William Murdoch, one of James Watt's best assistants, and known to fame as the inventor of the first system of gas illumination. Murdoch sincerely believed that steam could be successfully applied to locomotion, and in 1784 he proceeded during his leisure hours to make a working model of a small steam engine and carriage. Murdoch was a most skillful mechanic and far seeing engineer, so it was fair to believe that his model would be a creditable production. It was so

small that steam was generated by a spirit lamp, but the engine worked perfectly. It was a single cylinder,  $\frac{3}{4}$ -inch by 3-inch, single acting engine, and had a double headed piston valve with a hollow stem, through which the exhaust steam escaped.

In the first trial he made of this tiny engine Murdoch received an impressive lesson concerning revolution velocity. Experience with the slow moving, ponderous low pressure engines in use, did not lead people to think that there were possibilities of real velocity in steam. Murdoch was living on the outskirts of Rudruth, a Cornish town, and near a parsonage approached by the best road in the neighborhood. His engine was mounted on a small tricycle, which he determined to try on the parsonage road. One dark night he stole out of

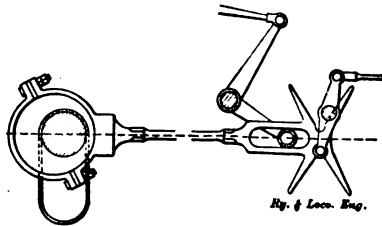

Fig. 200. Carmichael's Valve Gear

his lodgings with the tricycle under his arm, and set it down pointing straight to the church. The spirit lamp was lighted, and quickly generated a head of steam. Thinking the thing would start off slowly, Murdoch opened the throttle valve, and away the tiny carriage flew like a bird, the inventor chasing after it. The parson happened to be out walking on the road when the puffing, fiery sprite approached. The man of God yelled and took to his heels, thinking that a real personal devil was making a visit to his parish.

#### Watt Did Not Believe in Locomotives.

Watt, who, notwithstanding his inventive ability, was a weakly jealous man, objected to the experiment made by Murdoch, and the interesting toy was laid aside, and is still preserved in the successor to the Boulton & Watt Engineering Works. This is a good illustration of how carefully English people preserve articles that have figured in the development of mechanism.

Murdoch began applying the slide valve to stationary engines, and he has been credited with inventing that form of valve, but that is a mistake, the valve having been described in Hero's "Spiritalia," and tried tentatively by various experimenters during the renaissance of mechanical science.

### Trevithick Valve Motion.

When Richard Trevithick, the first man to build a locomotive to run on a railway, began his experiments in locomotive engineering, it was with a steam carriage to run on common roads. He used a single cylinder, and the valve gear consisted of plug cocks. In his locomotive proper, built in 1803, a slide valve was employed, operated by a tappit rod, an arrangement with projections to "tap" the valve connections.

Although Trevithick's locomotive was abandoned after a few trials, the valve motion part seems to have left its mark, for on

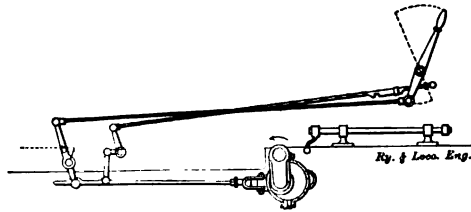

Fig. 201. Bury's Drop Hook Gear

nearly all locomotives, experimental and otherwise, subsequently built, the slide valve was employed, actuated in various ways.

### The Eccentric Appears.

The use of the slide valve was a decided step toward modern conditions, and the long popularity it has enjoyed proves it to have been a case of the survival of the fittest. The student of locomotive valve gear development naturally looks for the next step, and finds it to be the application of the eccentric for producing movements coincidental to the movement of the cranks. The word "eccentric" is formed of two words, *ex centric*—out of center. The inventor of the eccentric pulley, a disk secured away from the center on an axle, which produces the same kind of motion as a crank, is not known. It is like the crank, valve lap and many other devices used in engineering that have been applied without inventor's claims and have gained popularity through efficiency, by being better in their purpose than



any other attachment. Murdoch receives the credit from some writers of having invented the eccentric, but others say that it was in use in pumping apparatus long before his day. He merely revived a device that was dead for want of use, a thing that has happened very often in engineering.

Eccentrics were used on many steam engines long before locomotive invention was tried. The first illustration of the eccentric (Figs. 198 and 199) being used on a locomotive engine can be found in Woods' "Treatise on Rail Roads," published in 1830, and relates to George Stephenson's Killingworth engine, built in 1815. The invention is thus described: The sliding or steam valve is opened and shut at the proper periods by the following contrivance: a, Fig. 199, represents the axle of the traveling wheels of the carriage; a b is a lever fastened upon, and turning round, at the same time with it; b c is a circular

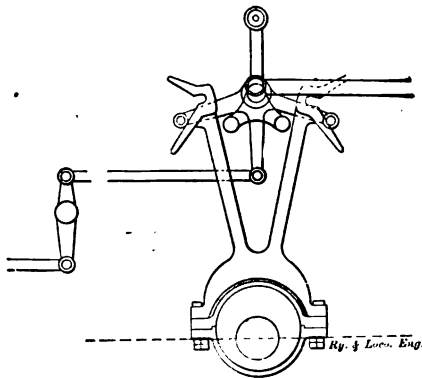

Fig. 202. Forrester's Valve Gear

opening in the eccentric circle d e, within which a pin, attached to the end of the lever a b, is at liberty to move; this eccentric circle is loose upon the axle of the carriage, and is only turned round when the pin, at the end of the lever a b, arrives at b a c, according to the direction in which it is moving; a circular hoop or strap of iron fits the circumference of the eccentric motion, connected to the lever f g h, which is moved backward and forward as the axle turns round; as this lever is moved, its motion is communicated to the arm i k, as shown, in Fig. 199, also, and through it, by the lever k l and rod l m, to the cross head m n, and so to the rod n o, of the sliding or steam valve, which as the carriage is moved forward, is thus worked up and down

to open and shut the communication between the two sides of the cylinder and the boiler at the proper periods."

The eccentrics were engaged in front and back gear by two clutches fastened to the axle, one behind each crank, the locking of the eccentrics being accomplished by a forcible lateral motion. It made a very efficient reversing device for slow motion and was highly superior to anything previously used.

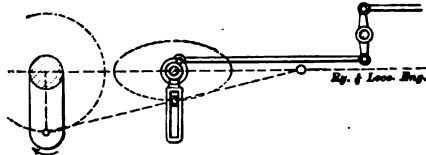

Fig. 203. Melling's Radial Gear

It will be seen from the illustration that the introduction of the eccentric to drive the valves of a locomotive was accompanied by the use of the rocker shaft, which was soon abandoned in European practice, and years afterwards became a regular arrangement on American locomotives.

### Objection to Loose Eccentrics.

Loose eccentrics worked fairly well on the slow moving locomotives used for hauling coal, the speed seldom exceeding six miles an hour; but when the time of higher speeds arrived, the inventive genius of two continents was stirred to devise

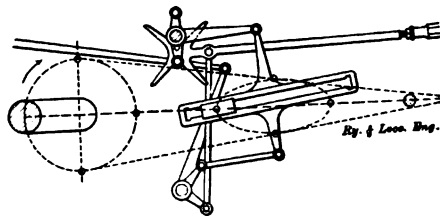

Fig. 203a. Hawthorne's Radial Gear

something that would endure the shocks of quick reversal. The mechanism that proved the most successful on early locomotives, and was modified in a multitude of ways, was invented by J. & C. Carmichael, of Dundee, Scotland, in 1818, for use on a steamboat. It was what in Britain was known as the gab hook, and in America as the V-hook, and is illustrated in Fig. 200. A single fixed eccentric had double forks at the end of the

eccentric rod, working on a rocker arm having two actuating pins. When the hook engaged one pin the steam was distributed to move the engine forward; when it took hold of the other pin, backward motion was produced.

Practically the same arrangement with drop hooks was used for several years by Mr. Baldwin, employed, in fact, until the double eccentric became popular.

### The Drop Hook.

Bury, the famous English locomotive builder, whose engines exerted so much influence on American locomotive practice, used at first a drop hook motion, shown in Fig. 201. A very decided objection to that motion was that four handles were necessary to operate the valve gear. The older race of American engineers remember this motion as having been used on nearly all New England built engines of early days, and it was on the Braithwaite engines used in the opening of the Philadelphia & Reading Railroad.

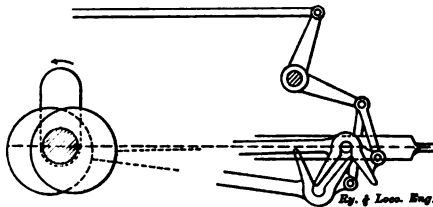

Fig. 204. Pauwel's Valve Gear

During the first two decades of railway operation, from 1830 to 1850, one of the greatest problems worked on by locomotive engineers was striving to produce a reversing and valve actuating mechanism that would give fair durability in service. Many wonderful contrivances were produced that received application through influential friends and were kept in operation long enough to be a dreadful example concerning the evils of complicated mechanism, and then disappeared.

Forrester & Company, of Liverpool, experienced machine makers, built a set of locomotives which obtained the nickname of "Boxers," which had the valve gear shown in Fig. 202. The motion was taken from a single eccentric, and was located directly above the axle. A critic said that the only merit this motion had was that it frightened the crows away from the farmers' fields along the route where the engines were in operation.

### Double Eccentrics.

Double eccentrics were first applied by William T. James, of New York, who used them first in 1829 on a road carriage, then on several locomotives. A drawing of them was sent to Forrester & Co., who did not perceive the merit of the invention, and it was introduced into European practice by the Hawthorns, of Newcastle, in 1837, and, like many other parts of locomotive improved mechanism, it is not known with certainty in Europe who first proposed the arrangement. It was, however, a very important advance movement, and prepared the way for the introduction of the link.

William T. James, of New York, used double eccentrics and a link motion in the United States as early as 1832, but the boiler of his engine exploded, destroying the whole engine, which was never rebuilt. It is not known if the double eccentric was his own invention or that of some of the steamboat engineers then actively

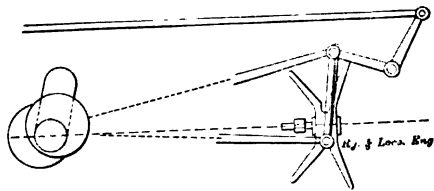

Fig. 205. Stephenson's Valve Gear

working out engineering improvements on American waters. The locomotive, however, did more than anything else to give the double eccentric popularity. They began to be used in the United States about 1835, and grew steadily into favor.

As there is no record of double eccentrics having been used on steamboats before James' time, it is safe to say that he deserves the credit of being the inventor.

### First Radial Valve Gear.

While the agitation devoted to improving valve mechanism was in progress, what afterward became known as "radial" motions first appeared. About 1832 a Mr. Melling, connected with the Liverpool & Manchester Railway, devised the motion shown in Fig. 203. He secured a pin on the middle of the connecting rod, which, by the nature of connecting rod motion, describes a species of elliptic curve, since become familiar to engineers through the action of Joy's valve motion, developed years afterward. The pin

worked in a slotted lever, of which the axis was placed in the center of the oval. The motion did not become popular, probably on account of its novelty, although it appeared to be a great improvement upon the labyrinth of rods, levers, pins, slots and hooks used as valve motion by many early locomotive builders.

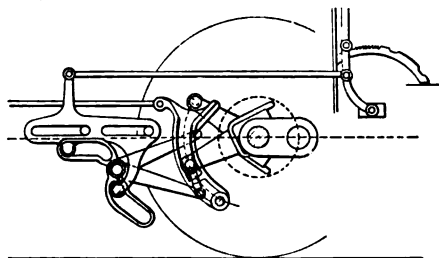

Fig. 206. Gray's Expansion Valve Gear

Another radial motion was introduced by Hawthorn & Co., Newcastle, about 1837, shown in Fig. 203a. This motion, like that of Melling, is actuated by a pin on the side of the connecting rod, and worked in a slotted link that transmitted only the vertical motion of the pin to the valve levers.

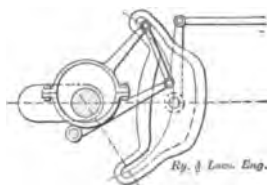

Fig. 207. Crampton's Expansion Gear

Among the early European valve gears that nearly approached the link in simplicity was that designed by M. Pauwels, a French engineer, about 1840, and shown in Fig. 204. He used the forked rods, placing them facing one another and linked to the reversing shaft above. A modification of this gear became the favorite V-hook gear of the United States.

The Stephenson valve gear of 1840, shown in Fig. 205, was also about as simple as a motion of the kind could be made, but no attempt was made to procure expansion of steam.

Very different from these was the Gray expansion gear of 1839, shown in Fig. 206, which was one of the first attempts to design an expansion gear without having an independent cut-off. This is a

crude sort of link motion. The pin of the eccentric rod worked in a segmental lever curved to the radius of the rod, the upper end of which was linked to the valve stem. This lever being concentric with the one rod at the beginning of the stroke, the rod could be raised or lowered in the slot of the lever to any required distance from the fulcrum which regulated the travel of the valve. Varying the travel of the valve, of course, produced varying admission of steam.

Another curious looking expansion gear was that brought out in 1843 by Crampton, shown in Fig. 207. This was a direct development of Carmichael's gear, and operated with a single eccentric.

### Roberts' Valve Mechanisms.

During the period when inventors and engineers were searching for a valve motion that would be simple and yet provide for the

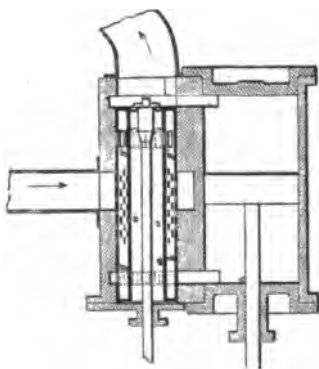

Fig. 208. Roberts' Piston Valve

working of steam expansively, several ingenious kinds of valve mechanism were produced. Richard Roberts, of Manchester, in 1832 invented the motion shown in Fig. 208. The valve of wrought iron was formed of two concentric tubes, a and b, the large pipe, b having holes perforated at o to admit steam from the steam pipe into the annular space between a and b. This annular space was closed steamtight at each end of the valve, and steam could only escape from it alternately to each end of the cylinder through the slots g and g<sup>1</sup>. The exhaust steam from one end of the cylinder went directly into the exhaust pipe, and from the other end it traversed the interior of the tube (a) of the cylindrical valve. These valves did not work well, as they did not expand equally with the cast-iron castings when heated by steam.

Mr. Roberts also invented a valve motion in which the valves were worked by mechanism connected from the opposite side of the engine. No eccentric was used, the movement being taken from a pin on the main rod.

Another ingenious production of the same engineer was a variable expansion gear, in which a supplementary valve worked in a casing at the back of the principal steam valve. This invention, modified by Gozenbach became the basis of many variable expansion gears used in America, the Cuyhoga cut-off, shown in Fig. 219, that became quite popular, having been one of them.

### Eastwick's Reversing Motion.

A very curious form of reversing gear, illustrated in Fig. 209, was invented by Andrew M. Eastwick, of the Eastwick & Harrison firm of locomotive builders, in Philadelphia, and largely used on Russian locomotives. Instead of reversing the eccentric or the valve, the valve seat was moved. In Fig. 209 E is the slide valve

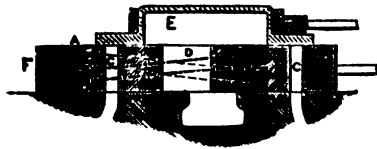

Fig. 209. Eastwick's Reversing Motion

and F a movable seat. When the block is set as in the middle figure, the front edge of the valve E admits steam to the front of the cylinder. By moving the block F a short distance, the steam admitted under the front edge of the valve E was conducted by another passage to the back of the cylinder.

### Invention of the Link Motion.

It has been proved beyond question that the link motion was first designed by that erratic genius, William T. James, of New York, as a simple form of reversing gear. It was applied to a locomotive built for the Baltimore & Ohio Railroad, but the boiler having exploded, as already mentioned, the invention was lost. In 1843 it was reinvented in the Stephenson Locomotive Works, at Newcastle, England.

What James had done was better known among European engineers than has generally been admitted. James had sent

drawings of the double eccentrics to Forresters & Co., and probably the link was also shown. The James engine had been tried in the Baltimore & Ohio competition of locomotives, where the principal engines in the United States and visitors from abroad were likely to be present and would naturally notice the peculiarity of the valve motion. As the engineering intercourse between the United States and Great Britain was then becoming very intimate it was not surprising that ten years after James' link motion was destroyed, it should appear in England as a new and original invention.

This happened in the works of Robert Stephenson & Co. with two mechanics named Williams and Howe, respectively, as claimants for inventing the device. As the Stephenson's were noted for covering every invention that originated in

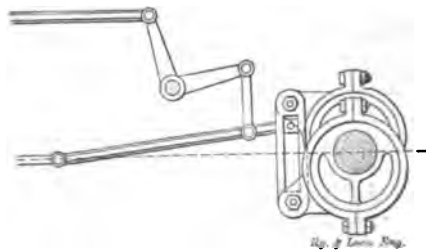

Fig. 210. Pretended Williams' Link Motion

their works by letters patent, their failure to patent the link raises the inference that they were aware that it had been used before.

In most treatises on the locomotive that deal with the invention of the link motion the statement is made that a youth named Williams made a sketch similar to that of Fig. 210, and that Howe, the foreman pattern maker in the Stephenson works, worked it out into the form shown in Fig. 211. Mr. Whyte, an old engineer living in America, as this is written, and who worked in the Stephenson establishment when the link motion was brought out, declares positively that Williams was the designer. He says that Williams drew a sketch similar to Fig. 210, but with a straight link, and it was given to Howe to make a pattern from. Howe made the pattern, and then pretended that he had invented the arrangement.

In 1846 the Glasgow Practical Mechanic published a series of articles describing the various forms of valve motion that





seldom went far astray on the designing of valve motion. The drop hook seemed to appeal to their idea of simplicity, and it was the popular valve motion for years, with the addition of an independent cut-off-valve.

### Vague Ideas on Steam Expansion.

It seems strange for a twentieth century engineer to reflect upon, but it is a fact that the pioneer engineers had very vague ideas about the advantage of steam expansion and how expansion could be most readily secured. This was curious for Watt had invented an indicator to show the practical action of expanding steam. Few of the early locomotives had more lap on the slide valves than was sufficient to prevent both ports from being partly open at the same time. A series of experiments were made on the Liverpool & Manchester Railway about 1844 with valves having about half-inch lap, and decided economy in the use of the fuel resulted. The chief engineer of the

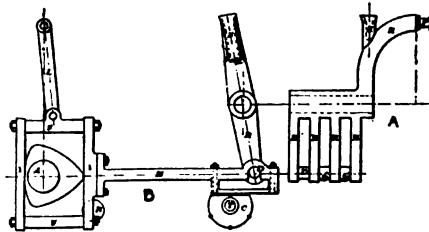

Fig. 212. Ross Winans' Valve Gear

railway, and most other engineers of that day, attributed the saving to the earlier release of steam that resulted from putting lap on the valve.

American engineers appear to have had a better conception than their European brethren concerning the effect of valve lap, for James, Davis and Long applied lap with a view to expansion of steam as early as 1832. When James and his foreman, Samuel Dougherty, were setting the valves of the engine having the link motion they found that by moving the reverse lever the travel of the valve was changed. James then remarked that the link would produce a variable cut-off. The only objection found to lap on this side of the Atlantic was that it caused difficulty in starting a heavy train. As handling the train easily was considered more important in the pioneer

railway days than saving fuel, few American locomotives had their valves equipped with much expansion producing lap until the link motion came into use. When the men in charge of our railroad machinery began to realize the advantage of expansive working, they applied independent cut-off valves, which did not interfere with the starting power of the engines, in preference to lap. The introduction of the link motion did not immediately displace the independent cut-off, but it gradually fell out of favor as the attributes of the link motion became understood and its merits became appreciated.

### Winan's Valve Gear.

Ross Winans, as might have been expected, had ideas of his own concerning valve motion, and he employed a cam instead of an eccentric, and had different mechanism from other

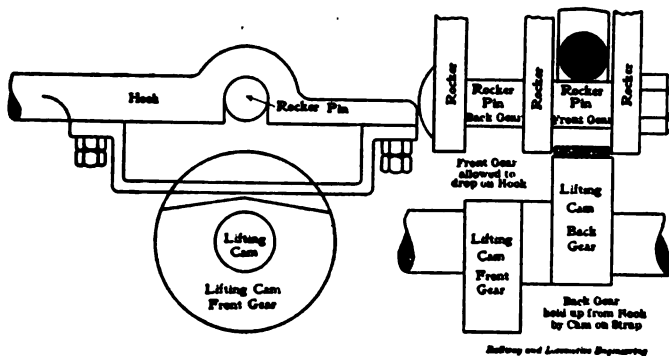

Fig. 213. Common Form of Drop Hook Motion

people to give motion to the valves. On valve motion, as on most other engineering questions, Ross Winans was a law unto himself. He understood more about steam and its ways than other engineers, and his practices in designing were influenced by his knowledge.

Figs. 212 and 213 illustrate the valve motion that Winans applied to his camel back engines. The cut-off mechanism was peculiar in that it worked steam expansively, while all the time operating the valve its full stroke, and it is claimed by many engineers that it was the nearest approach to an ideal cut-off ever made on locomotives, using as it did but one valve, and being particularly simple. The valve motion of the day was the drop hook, and this Winans adopted, and added the cut-off.

Across between the frames of his "camel," just in the center of the wheel base, was a shaft on which were the two rockers—one for each side. These rockers, shown in A, had a curved arm that extended over the wheels and terminated in a bearing for the back end of the valve stem, as shown at P; on top of this curved arm was cast a socket, shown at S, for inserting the starting bar when necessary. The shaft went through the body of the rocker, as shown by the dotted lines; below the shaft there were four arms carrying at the bottom a steel pin or bolt that extended through them all, forming three bearings, as shown at D, D', D'', B. Now, there were two eccentrics on a side—one set for the forward and one for the backward mo-

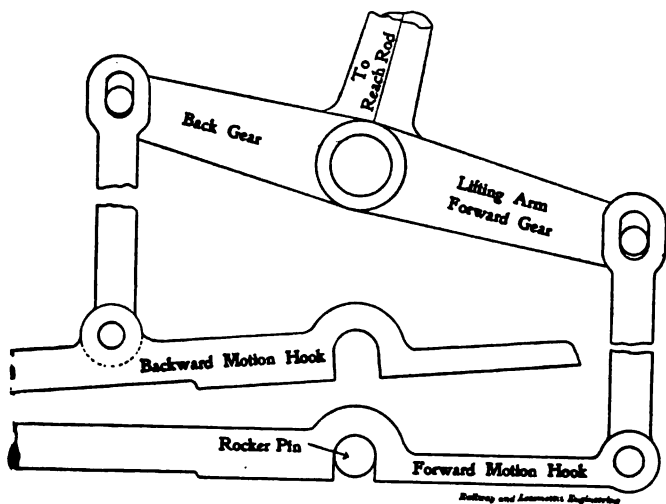

Fig. 214. Method of Reversing Drop Hook Motion

tion; these eccentrics operated drop hooks, each having its own place in the lower end of rocker. Then, besides the eccentrics, there was a cam, as shown in B, operating another hook. This cam worked in a square frame or yoke (Y), as shown, the frame being suspended from the boiler by the hanger L, and it operated a hook (H) exactly like the drop hooks of the eccentrics.

The reverse lever merely tumbled the shaft T, and this shaft carried six cams like C, three for a side, each cam being under a hook. When the lever was in the center, or "out" notch, all the cams were turned enough to lift the hooks clear of the pins

in the lower arms of the rocker, and the valves would not operate while the hooks worked back and forth, sliding on the cams. If the lever was put into the back-up notch, the cams under the back-up hooks presented their low sides at the top, and the back-up hooks would fall down and engage the pin D', and operate the back-up gear.

If the lever was put in the forward notch, the back-up hooks were lifted and the forward motion hooks dropped into gear.

Ahead of the forward motion notch there was another, for the cut-off, and when the reverse lever was dropped into that, both forward and back motion hooks were lifted out of gear, and the hook of the cut-off cam dropped in.

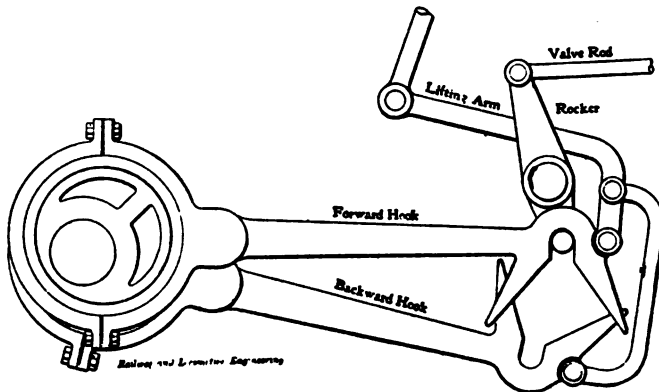

Fig. 215. Common Form of V-Hook Motion

There was a guide, or yoke, under each hook, to prevent the top from striking the rocker, and to provide a rest for the hook to slide on when out of gear. These hooks had nothing to hold them in gear but their own weight, and the friction in forward motion, and once in a while in backing up, if the eccentric got dry, they would unhook. If the engine was standing still and out of gear, or it was desired to change from forward to back, or vice versa, the hook that was out could not be engaged with the pin D, so a starting bar was dropped into the socket S on the rocker, and the rocker moved until the hook engaged the pin; then the bar was taken out and set into a stationary socket provided for it.

The "four motion cam," as it was called, was so shaped that it filled the frame Y in every position, so that there was no knock. It caused the valve to travel five inches, just as the

eccentrics did, but the valve stood still twice during each revolution. When the pin, which is shown at B, was at the dead center, the valve was opening very fast, and opened wide almost instantly, and closed with a quick motion when the pin reached the quarter; here the valve rested, allowing the steam to work expansively, while at the same time holding the exhaust open for the other side, until the piston had traveled nine-tenths of the stroke.

### The Favorite Drop Hook.

The most common form of drop hook motion used in the United States is shown in Fig. 214, which gives the motion for

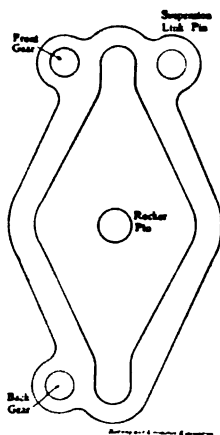

Fig. 216. Rogers Connected Double Hook

forward or backing eccentric. Throwing the reverse lever forward held the backing hook out of reach of the rocker pin and allowed the forward hook to drop upon the pin when it came into position. The starting bars were connected with the valve rods and enabled the engineer to move the valve till the hook would drop into place.

This form of motion was used by the Amoskeag, Taunton, Rogers and others, and many engineers of those days declared it could not be beaten.

### The Favorite V-Hook.

The V-hook motion, which came decidedly into favor after being introduced into the United States about 1842, proved a

good compromise between the drop hook and the link. It became popular principally through the engineers finding it easier to operate than the drop hook and because it involved the use of fewer parts. Fig. 215 is a fair representation of the V-hook motion used on nearly every railroad in the United States in 1850. When the motion was put in forward gear the hook of the forward eccentric engaged the rocker pin, at the same time dropping the backing hook so that it swung clear. When the back-up hook was engaged in the rocker pin the forward motion in its turn was raised and swung clear of the other parts.

### American Invention of Cut-Off Motion.

There were so many concerns that engaged in the work of locomotive building in the first four decades following 1830 that the most select mechanical ability of the country was de-

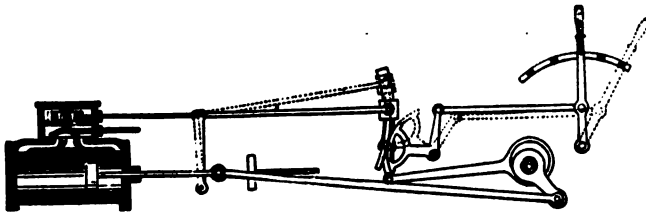

Fig. 217. Baldwin's Variable Cut-Off Motion

voted to the improvement of the locomotive. This was frequently manifested in the invention of curious valve motions that were applied to a few locomotives and then disappeared. As these appliances, although frequently very ingenious, exercised no permanent influence upon the locomotive, it is not necessary to go into particulars.

The native ingenuity was fertile enough to produce curious combinations of mechanism intended to produce the equivalent motion, but the performances of foreign inventors and designers were largely drawn upon to magnify the variety of valve gears tried by locomotive builders in the United States. This was particularly the case when cut-off arrangements were called for. I have examined a great many cut-off motions that had popularity among our early railroad men and they can nearly all be found illustrated in the Practical Mechanism of 1846, published in Glasgow, Scotland, or in Clark's "Railway Machinery," published in 1850.

One of the most famous cut-off motions used was the Cuyahoga, illustrated in Fig. 219. That was first applied by the Cuyahoga people in 1850. Now compare it with the Gozenbach motion shown in Fig. 218 which was patented in 1843.

Baldwin's valve motion developed by degrees from the most elementary form. On his first locomotives a single shifting eccentric was used with a stop for holding it in position, as illustrated in Fig. 198. That was soon abandoned for a single fixed eccentric. With the single fixed eccentric for each cylinder, each eccentric strap had two arms attached to it, one above and the other below, and as the driving axle was back of the fire box, these arms were prolonged backward under the foot board, with a hook on the inner side of the end of each. The rock shaft had arms above and below its axis, and the hooks of the two rods of each eccentric

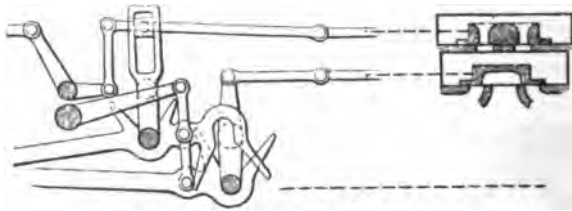

Fig 218. Gozenbach's Cut-Off Valve Motion, 1843

were moved by hand levers so as to engage with either arm, thus producing forward or backward motion. This motion was adhered to for four or five years.

The first change made by Mr. Baldwin in his valve motion was to adopt the double eccentrics with a single flat hook. In 1845 he built some locomotives for Austria with a sort of link motion. It did not indicate, however, that he had come to favor a link motion, for in the same year he introduced what was known as the half stroke cut-off. In this device the steam chest was separated by a horizontal plate with an upper and lower compartment. In the upper compartment a valve, worked by a separate eccentric and having a single opening, admitted steam through a port in this plate to the lower steam chamber. The valve rod of the upper valve terminated in a hook which engaged with the upper arm of the rocker shaft. When thus working it acted as a cut-off at a fixed part of the stroke, determined by the setting of the eccentric. It was an inferior cut-off.



### ·Appreciate Value of Using Steam Expansively.

By this time American locomotive builders had come to realize the importance of using steam expansively, and most of them were putting variable expansion gears upon their engines. After using the half stroke cut-off for about eight years, Mr. Baldwin in 1853 introduced the variable cut-off arrangement illustrated in Fig. 217.

Concerning this motion Mr. Baldwin wrote: "I shall put on an improvement in the shape of a variable cut-off which can be operated by the engineer while the machine is running, and which will cut off anywhere from 6 to 12 inches, according to the load and the amount of steam wanted, and this without the link motion, which I could never be entirely satisfied with."

That was written ten years after the link motion had been introduced, and indicated that that motion was slow in finding favor among American engineers.

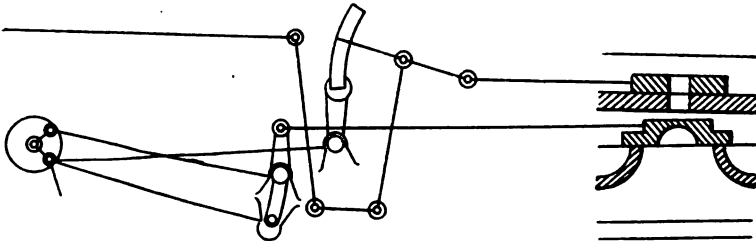

Fig. 219. Cuyahoga Cut-Off, 1850

While describing this cut-off Mr. Baldwin acknowledged that it was the same as that used by the Cuyahoga Works, with the added partition plate.

### Rogers Introduces the Link Motion.

On the first two locomotives built by Rogers, Ketchum & Grosvenor drop hooks were employed, operated by eccentrics placed outside of the driving wheels. Early realizing the necessity of a valve motion that would provide for using the steam expansively, in 1843 he designed and brought into use the motion shown in Fig. 221. That was a rather complex motion, with a separate chamber for cut-off valve. A few years later Mr. Rogers began to apply another motion, which was a slight improvement on the other, but still was a lamentable conglomeration of levers, pins, rods and hooks.

He next built some engines that had the double V-hook arrangement shown in Fig. 216, which was practically a link worked all the time in full gear. With that a riding cut-off was used, double hook naturally led to the link motion.

### Prejudice Against the Link Motion.

There existed among American railroad master mechanics and locomotive builders a strong prejudice against the link motion, and complex mechanisms continued to be invented to perform the functions that the link did very satisfactorily with a minimum of parts.

Thomas Rogers was the first American locomotive builder to rise above the prejudice against the link motion. In 1849 he intro-

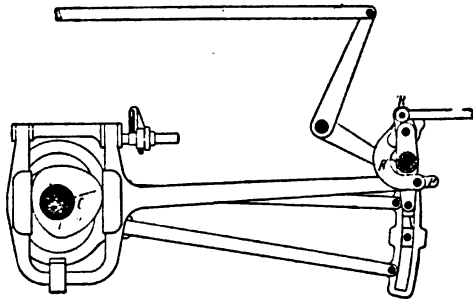

Fig. 220. Uhry & Luttgens' Cam-Link Motion, 1866

duced the suspended link motion shown in Fig. 222 upon some locomotives built for the Hudson River Railroad. In this motion the link remains stationary and a radius rod extending from the link block to the rocker arm transmits the motion of the eccentric. That motion was popular on some European railways, but the shifting link motion has been the real link motion of American locomotives.

Rogers soon changed to the under-hung shifting link shown in Fig. 223. For years that form of suspension rivaled the upper-hung link in the favor of our master mechanics.

### "John Stevens" Valve Motion.

The persistence of the sentiment in favor of independent cut-off valves is very well illustrated in the valve motion of Stevens

engines built for the Camden & Amboy Railroad in 1849. Referring to the mechanism illustrated in Fig. 230, the two main eccentrics were located inside the wheel and operated the large double hooks shown, with the curved lifting rod. These worked the main rocker arm and the main valve, and the reversing was done by changing from one hook to the other by handling one of the levers in the cab. The independent cut-off was a small valve riding on top of the main valve and operated by a return crank eccentric on the main crank pin. This motion was transmitted to the valve through the back rocker.

The upper valve stem was supported in a guide, and at the end of the square part of the rod there was a joint to which was pivoted the rod whose other end terminated in the double V-hooks. This loose end was supported and held by the bell crank

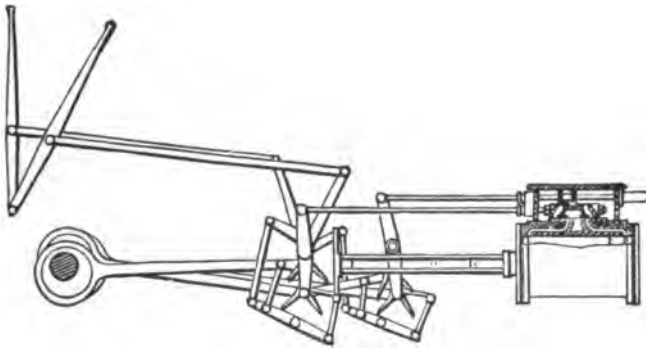

Fig. 221. Rogers' Valve Motion

shown back of the cylinder. On the upper valve stem there was a loose block running as a crosshead on a square section of the rod. This was driven by the cut-off eccentric. Just below it on the main valve stem was another block held rigid by screws. This block also carried a pin that could be engaged by the lower V of the double hook.

In starting the cut-off lever was moved to engage the lower hook. This made the cut-off valve come to the center of the main valve, and as that always ran full stroke, it would cut off steam, the cut-off motion merely sliding, the block on the upper rod doing no work. As soon as the engine was under way the engineer threw on the cut-off, which disengaged the lower hook from the main valve stem and engaged the upper one with the cut-off valve, which traveled on top of the main valve, cutting the steam off

short, much as the link does when notched up, except that, as the main valve controlled the exhaust, the latter was carried well to the end of the stroke.

That motion was designed by Edwin A. Stevens, who founded the Stevens Institute of Technology, Hoboken, N. J., and seven of the engines were built by Norris, of Philadelphia, in 1849. It was first applied to a high speed locomotive called the "John Stevens."

### Opposition to Link Motion Overcome.

Although the introduction of the link motion was vigorously opposed by many master mechanics, it forced itself steadily into use, and in a few years became the recognized valve motion for locomotives over the whole of the American continent. The sim-

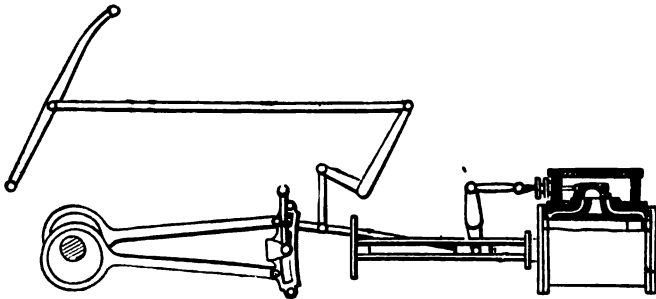

Fig. 222. Rogers' Suspended Link Motion

licity of the device soon made it popular with the men who handled the locomotives, and the rarity of breakage, with the low cost of repairs, brought it into favor with the officials responsible for locomotive operating. Mr. Baldwin had opposed the use of the link motion for theoretical reasons; but in 1854 he built some engines for the Central Railroad of Georgia, one having the link motion specified, while the others had the Baldwin variable cut-off. This was understood to be a test case. The officials of the road, after a few months' experience with the two forms of valve motion, decided positively in favor of the link, and Mr. Baldwin concluded that he had been mistaken in his opposition to the link motion, and became one of its fast friends. Nearly all other locomotive builders in America by this time had been converted to patronize the link motion.

### Link Motion Very Satisfactory for Years.

After the link motion had been introduced into Great Britain and the United States there was for many years little disposition

manifested to make improvements except in minor details. The principal objection manifested to the link motion in Great Britain was its causing increase of lead when notched up. In the United States, where small driving wheels were the rule, this tendency to increase the lead was regarded as a merit rather than a defect, but in Britain it led to the inventing of several motions that produced constant lead or very little increase of the same. Among the motions thus invented, the best known was the Gooch, Fig. 222, first used by Rogers, and the Allan or straight link, Fig. 234. Both have their good points, but the curved shifting link, wrongly known as the Stephenson, is almost universally used in the United States. Early locomotive builders and master mechanics experimented to some extent with the novel link motions mentioned, but they did not find any reason to deviate long from the shifting link.

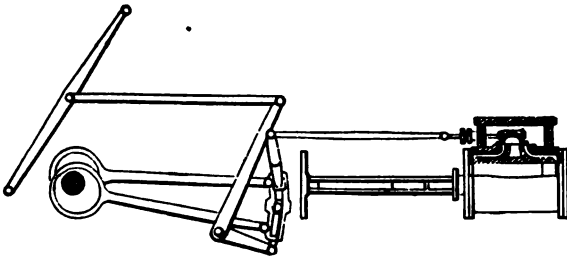

Fig. 223. Rogers' Under-Hung Link Motion

### Where Radial Valve Gears Were Popular.

The locomotive engineers of the continent of Europe did not, however, feel moved to accept the link motion as all that could be desired. From the beginning of the railway era they displayed partiality for some sort of radial motion, a species of movement that appeals to certain minds with geometrical tendencies. About 1840 Hensinger von Waldegg introduced into Germany, and Walschaert into Belgium, a form of valve gear now known as the Walschaert motion, which has gained high popularity on continental railways.

### First Radial Motion Used in America.

Radial valve motions of various kinds have been repeatedly tried by American locomotive builders, but somehow they generally returned to the link. Early in the 40's the Niles Locomotive

Works, of Cincinnati, built some locomotives for the Beaver Meadow Railroad, now a part of the Lehigh Valley Railroad, and they were equipped with a radial valve gear that had a small return crank and a connection with the crosshead to drive the valve. It was designed by John L. Whetstone, then superintendent of the Niles Locomotive Works. It was not the Walschaert motion, but was of the same general type. There did not appear to be serious objections to the motion, but no other engines except those made by the Niles people were equipped with it at that time.

### Various Radial Motions.

Another radial gear with one eccentric was patented by John Wesley Hackworth, son of Timothy Hackworth, the famous pioneer locomotive engineer, in 1859. The gear had no run of popularity, because British locomotive builders were satisfied with the link

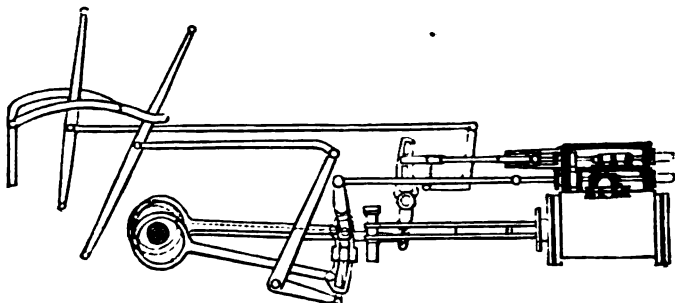

Fig. 224. Rogers' Link Motion and Independent Cut-Off

motion, but it had features that would have made it a serious competitor of the Walschaert gear under favorable circumstances.

It does not come within the scope of this work to describe the Hackworth motion in detail, but people interested will find full particulars beginning on page 92 of the Eighteenth Annual Report of the American Railway Master Mechanics' Association.

Another radial gear that was applied to many continental locomotives was developed by Charles Brown, of the Swiss Locomotive & Engine Works, at Winterthur, Switzerland. A full illustrated description of this gear will also be found in the report of the American Railway Master Mechanics already referred to.

### Joy's Valve Motion.

In 1879 David Joy, an English locomotive superintendent, patented a valve motion illustrated in Fig. 225. It is a radial gear

without any eccentric or its equivalent, all the movements of the valve being regulated by levers connected with the main rod and a sliding link.

The motion for the valve is taken direct from the connecting rod and by utilizing independently the backward and forward action of the rod, due to the reciprocation of the piston, and combining this with the vibrating action of the rod up and down, an ellipse movement results which is employed to actuate the valves of engines using any combination of lap and lead desired, and giving an almost mathematically correct cut-off for both sides of the piston for forward and backward motion, and for all points of expansion intermediately.

From a point, A, Fig. 225, in the connecting rod, motion is imparted to a vibrating link, B, constrained at its lower end, H, to move vertically by the radius rod, C, which is pivoted at I.

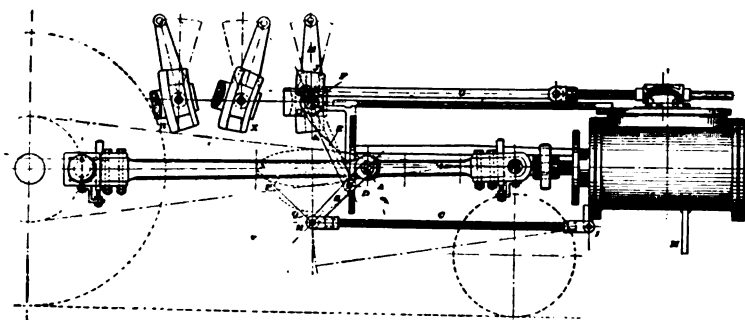

Fig. 225. Joy's Valve Motion

From a point, D, on this vibrating link, B, horizontal motion is communicated to the lower end of a lever, E, from the upper end of which lever the motion is transmitted to the valve stem by the rod G. The center or fulcrum, F, of the lever E, partakes also of the vertical movement of the connecting rod to an extent equal to the amount of its vibration at the point A; the center F is for this purpose carried vertically in blocks which slide in slots in the links JK, which are curved to a radius equal to the length of the rod G, connecting the lever F to the valve stem. Reversal is effected by moving the curved slide.

#### Mason's Walschaert Motion.

About 1875 William Mason began applying the Walschaert valve motion to locomotives, and many engines were so equipped,

particularly those built for narrow gauge railways. The arrangement he used is illustrated in Fig. 226.

The main link N was worked from a crank in the main crank pin, which was several inches outside of the center line of the cylinder. To keep the center line of the valve seats inside of the center of the cylinders, the lever P O worked from the crosshead, and to which the radius arm N P was coupled, was connected to the block Q, which was bolted to the guide bar R S. The lever P O was connected to the outside of the block Q, which was fastened to the guide bar, and the valve stem T was attached to it on the inside. By this means the motion of the lever P O was transferred to the center of the valve stem and valve seat, which was  $3\frac{1}{2}$  inches inside of the center of the cylinder.

As the point of suspension of the radius arm N P has a great influence on the motion of the valve, the upper end of the link

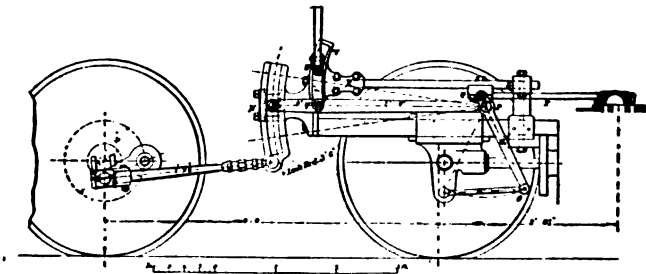

Fig. 226. Mason's Walschaert Motion

U V, to which the radius arm was hung, was attached to a block which worked in the slot of a stationary link or guide W. By that means the point of suspension U conformed to the curve of the slot, producing nearly uniform distribution of steam at both ends of the cylinder.

Mason's Walschaert valve gear was illustrated and described in a report presented to the Railway Master Mechanics' Association convention in 1885. From the remarks made about it, we judge that sentiment among master mechanics was decidedly opposed to the motion.

What I learned from people in charge of locomotives at that time having the Walschaert valve gear led me to think that ignorance concerning the adjustment of the mechanism was at the bottom of the opposition to the motion. The common talk was, it has too many joints, and that the pins wore rapidly, defects



which were not beyond a remedy, had the desire existed to keep the motion in use.

### Early Pennsylvania Railroad Valve Motion.

Baldwin's people built for the Pennsylvania Railroad a lot of engines that were well known in the early 50's, which had the valve motion shown in Fig. 231. The valves were worked by single V-hooks, the cut-off being a positive half stroke working upon a partition plate. The outer end of the valve rod ended in a sort of drop hook which, by means of a lever and tumbling shaft of its own, could be lifted from or placed on the pin at the top of its own rocker arm. The arrangement of the motion can be readily understood by a study of the engraving.

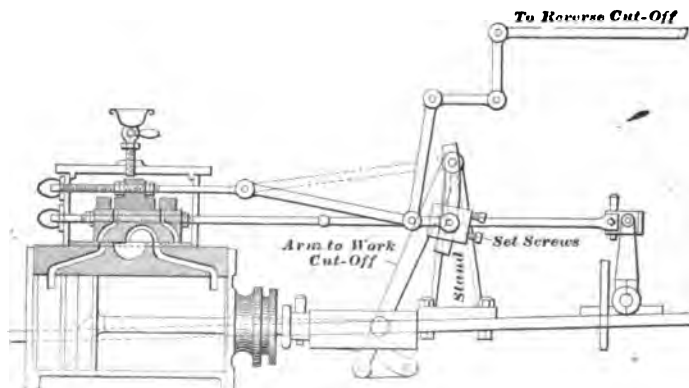

Fig. 227. Ray's Cut-Off Motion

### Sectional Prejudice for Early Mechanism.

In the early days of railroading and locomotive building in the United States, in the days before the Railway Master Mechanics' Association made the whole country a unit of practice, certain sections adhered to their own fads and fashions. New England kept turning out inside connected engines long after they had ceased to be accepted in other sections, and New England was the last to give up the drop hook.

### Various Cut-Off Valves.

Nearly all New England locomotives of the 1850 period had cut-off valves. The cut-off was a simple open valve, like a throttle, in a separate steam chest above that of the regular slide valve, and might be adjusted to stop the flow of steam

into the cylinder at any desired part of the stroke, which was sometimes one-half or two-thirds. These valves were actuated by eccentric rods and rocker arms similar to those of the main valves, and were thrown out of action when starting by means of a lever in the cab.

A device was introduced a few years before the invention of the "link motion" called "Gray's cut-off," by which the steam could be stopped or cut off at any part of the stroke, and could be varied at will by a lever in the cab. This was done by attaching the valve rod to a block which worked in a slot in the upper rocker arm. This device met with much favor, but was rendered useless when the "link" was adopted.

A sketch of the interesting motion shown in Fig. 227 was sent to me by Walter S. Phelps, Muncie, Ind. The main valve had ports for steam passage into the cylinders through openings

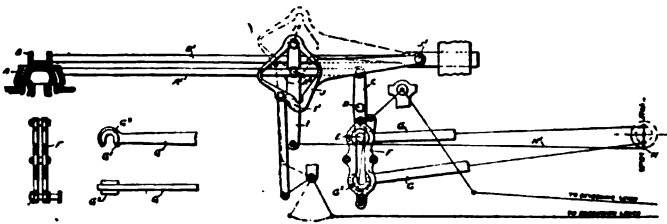

Fig. 228. Valve Motion Used by Norris

at the ends. Over this was a riding cut-off valve, with openings shown. The cut-off valve was actuated from the cross-head by mechanism resembling Joy's motion. A stand was erected upon the frame and held the swinging arm that gave motion to the valve.

The principal objection to this form of cut-off motion was that few mechanics in its day were capable of adjusting the valve movement. When it was wrongly adjusted it failed to admit steam at the right time.

### Balanced Valves.

The first trend of improvement on valve motion displayed in America after the introduction of the link motion was in favor of balanced valves. The reports of the annual conventions of the American Railway Master Mechanics' Association furnish a reliable history of the efforts made to perfect valve motion after 1870.

A sentiment arose that moving unbalanced slide valves involved exaggerated waste of power, and a variety of inventions offered remedies and substitutes. In the Annual Report of the Master Mechanics' convention of 1870 twelve forms of balanced and anti-friction valves were mentioned. Arrangements of rollers came considerably into use, the valves moving on the rollers. Rotary valves of various novel forms were tried, and several peculiar arrangements for balancing the valves. The most popular balancing arrangement was invented about 1870 by G. F. Morse, superintendent of the Portland Locomotive Works. The balancing arrangements were the most satisfactory

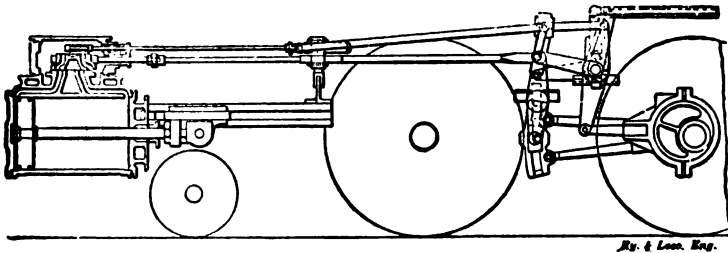

Fig. 229. David Clark's Valve Motion

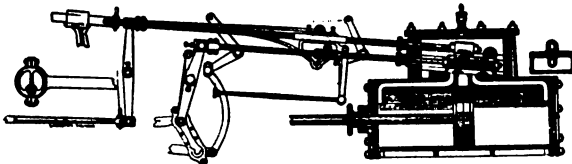

Fig. 230. John Stevens' Valve Motion

provisions for reducing the friction of slide valves, but they did not become popular as long as the valves were small. About 1880 balanced valves gradually began to come into favor, and a few years afterward "balanced valves" became a regular item of specifications for new locomotives.

### Richardson Balanced Valve.

About 1880 George Richardson, noted as the inventor of the pop safety valve, made an improvement upon the Morse balancing device which greatly increased its efficiency and brought it rapidly into popularity. By means of steamtight strips secured on the top of the rectangular valve the Richardson bal-

ance relieves a certain proportion of the top of the valve from pressure.

### American Balanced Valve.

In 1893 the Wilson American Balance Valve began to come into use, and it has gradually grown in popularity until it now divides the business with the Richardson balance valve. By the Wilson invention the relief of pressure on top of slide valve is effected by a circular plate kept tight by packing rings.

### Piston Valves.

In 1898 the Brooks Locomotive Works began recommending piston valves, and that form of valve is now becoming very common. In many instances the piston valves admit steam on the outside edges of the heads, making the action practically the same as the flat slide valve. In other instances admission of

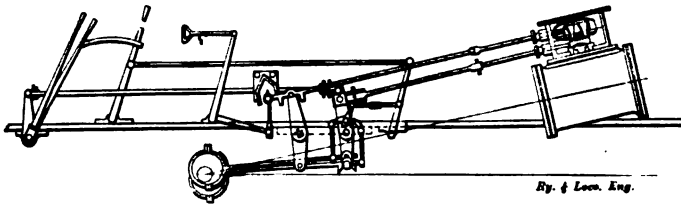

Fig. 231. Early Pennsylvania Railroad Valve Motion

steam is made between the heads and the exhaust steam escapes at the ends. Both arrangements have merits and drawbacks peculiar to themselves.

### Demand for Improved Steam Distribution.

The objections originally urged against the link motion, that it produced slow admission and early release of steam, experienced a temporary revival in the United States about 1870. Men well informed on steam engineering began arguing that a valve motion ought to open the steam port rapidly, cut off promptly when the required volume of steam was admitted, then open for release when the stroke of the piston was nearly completed, and open wide enough to prevent back pressure. They also wanted the valve kept open during release long enough to produce very little compression. These were functions the link motion performed rather imperfectly.

Locomotive engineers shared the belief, still prevailing among steam engineers generally in America, that simple engines with properly devised valve gear could use steam to greater advantage than through the more expensive compound engines. The advantage that comes from preventing extremes of cylinder temperature had not been generally recognized.

### A. J. Stevens' Valve Motion.

The first notable attempt to overcome these reputed shortcomings of the link motion was made by A. J. Stevens, of the

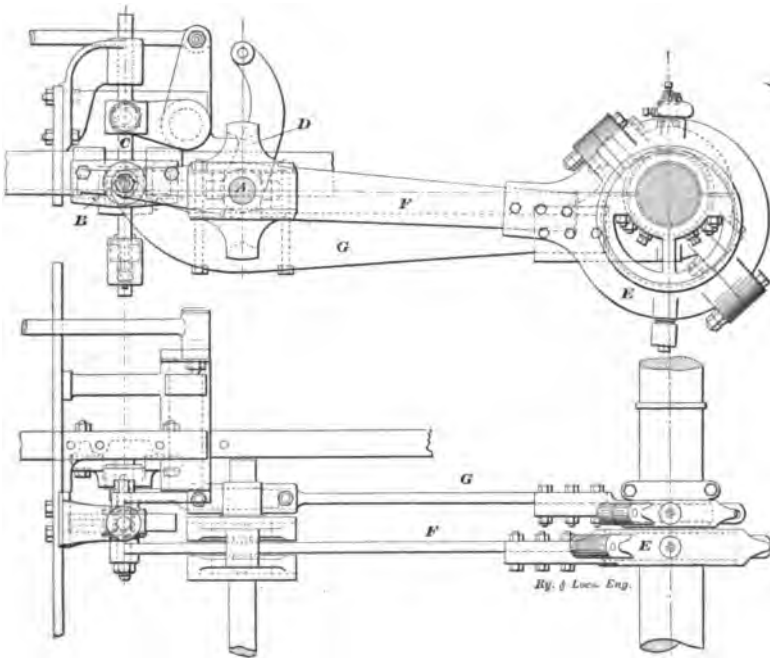

Fig. 232. William Wilson's Valve Motion

Southern Pacific Company, and is illustrated in Fig. 235. This valve gear was applied to many locomotives by the inventor, and had a high reputation for efficiency. The motion was a modification of the Hackworth gear, and double valves were used, with Allan supplementary passages for both admission and release.

The combined motion of a single eccentric and crosshead lever imparts movements to a sort of wrist plate D, which

actuates two valve stems, one for each valve. Under this arrangement the valve opens sharply for admission till the port is wide open, and in that position it remains for an instant and then closes quickly. It was an ideal valve motion, performing the functions of quick opening of port, quick cut-off, protracted release and small compression, all the movements having been remarkably rapid.

I believe that had a company, powerful enough to push its merits before railroad officials, taken up this motion in 1883, it would have become the standard valve motion of nearly all American railroads.

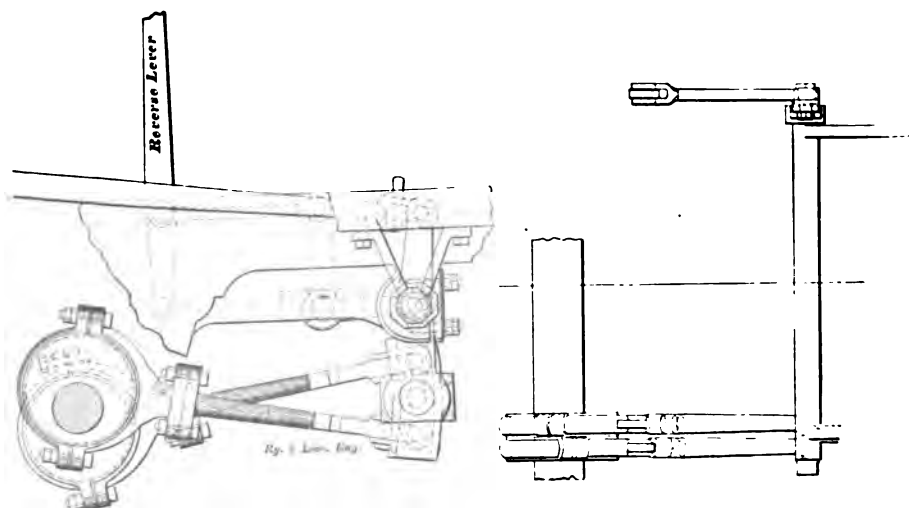

Fig. 233. Baldwin's First Link Motion in 1845

### David Clark's Efforts.

About the time Mr. Stevens designed that gear, David Clark, of the Lehigh Valley Railroad, brought out a locomotive valve gear with an independent cut-off, the main valve being driven by a link motion, as shown in Fig. 229. The gear and indicator diagrams taken from a locomotive equipped with it are illustrated in the Eighteenth Annual Report of the American Railway Masters Mechanics' Association. The diagrams, two being shown on page 199, are probably the finest ever taken from a locomotive, and have the clean cut points commonly made by the best forms of automatic cut-off engines. They are marvelous indicator diagrams, and the engine ought to have done its work with the smallest possible volume of steam; but, strange to say,

it never did the work with the same economy of fuel as link motion engines engaged on the same service.

This gear called for six eccentrics and rods, four rocker shafts, two reverse levers and rods, and two additional valves, valve seats, valve stems and stuffing boxes. The motion produced very pretty indicator diagrams and promoted scientific conversation among mechanical engineers.

### William Wilson's Valve Motion.

Another very ambitious attempt to improve the valve motion of locomotives was made in 1885 by William Wilson, mechanical superintendent of the Chicago & Alton Railroad. The motion shown in Fig. 232 is of the radial gear type, but the movement of the valve is taken entirely from a single eccentric, and its rod fulcrumed so as to produce an ellipse. In the main, the device con-

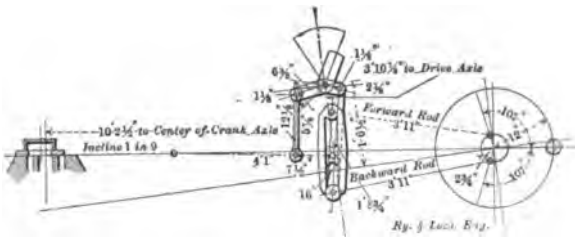

Fig. 234. Allan's Straight Link

sists of the eccentric E, its rod F, the reversing gear D and the upright actuating rod C, attached to the rock shaft operating the valve rod. The motion is taken from the eccentric, to which is attached the fulcrumed rod, the fulcrumed bearing A passing over or through guides in the reversing shaft, which is supported on the radius bar G to equalize or correct the inequalities of the motion caused by the vertical movement of the driving boxes. This shaft is held in boxes, and is connected by an arm to the reverse lever, and can be partly rotated in its bearings by the movement of the reverse lever. While the reverse lever is in mid gear the guides on this shaft stand in a horizontal position, and therefore the fulcrum of the eccentric lever travels in a horizontal direction. Any movement of the reverse lever back or forward throws the guides on the reversing shaft out of the horizontal position, and at an angle either one way or the other. The direction in which it is thrown controls the direction of the movement of the engine, and the dis-

tance it is thrown controls the travel of the valve. The rear end of the eccentric rod has the same motion as the eccentric, and the forward end or point B describes an ellipse whose length corresponds with the throw of the eccentric, and whose diameter is regulated by the position of the reverse lever. The smallest diameter of the ellipse, or that described when the reverse lever is in the center notch, must be twice the lap and lead of the valve.

When the piston of an engine equipped with this gear is on the dead center, an imaginary line passing through the center of the eccentric rod fulcrum would also pass through the center of the reversing shaft. Therefore any movement of the reversing shaft on its axis would not stir the eccentric rod, and a constant lead is maintained, no matter where may be the point of cut-off.

The special merits claimed for the motion are quick opening

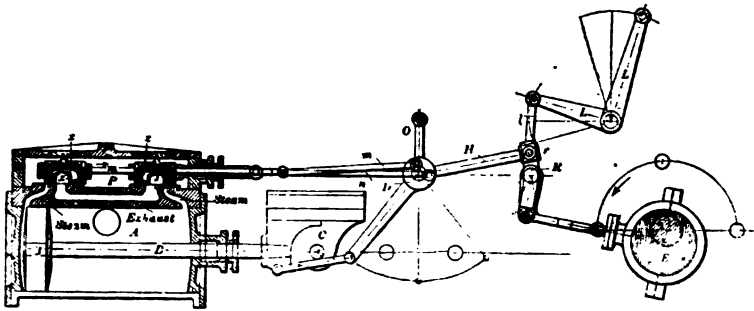

Fig. 235. Stevens' Valve Motion

and closure of ports, a constant lead, a correct and equal cut-off, exhaust opening and exhaust closure with protracted release while cutting off early.

Indicator diagrams taken from the motion demonstrated that the claims of the inventor were well founded, so far as the distribution of steam was concerned, but the locomotives equipped with the motion used more coal doing certain work than did engines of the same general dimensions equipped with the link motion.

Two years later Mr. Wilson still further elaborated his valve gear, but it did not induce any other person besides the inventor to use it.

### Strong's Locomotive Improvements.

About the time that William Wilson was sacrificing himself upon the valve motion improvement altar, George S. Strong, of Philadelphia, made a series of very persistent attempts to provide a substitute for the link motion. He tried several kinds of motion,



but finally settled upon a radial gear of the Hackworth order actuating gridiron valves, its elements being shown in Fig. 232. His idea was to produce a gear which under almost all conditions of speed would give uniformity between boiler and admission pressure, doing away with wire drawing and reducing the back pressure to the lowest limits. Independently worked valves were used for admission and exhaust.

A company was formed to put upon the market locomotives having this valve gear and other novel features worked out by Mr. Strong. Two engines were built and did service of an advertising character on various railroads. No demand arose for that kind of locomotive.

### Rejuvenescence of the Walschaert Valve Motion.

During the year 1904 one or two railroad companies tried the Walschaert valve motion for heavy engines because, being located

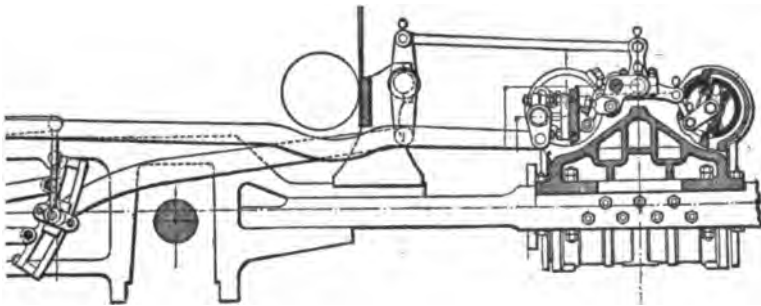

Fig. 236 Section of Young's Adaptation of the Corliss Principle

outside of the running gear, it was much more convenient to reach than link motion. Walschaert motion immediately became the fashion and the indications are that it will be applied to many locomotives in future.

There are several odd forms of valve motion before the railroad world at present, but nothing likely to effect a revolution.

### Martyrs to Valve Motion Inventing.

As long as inventive ability is active among us, and opportunities exist for reducing the volume of steam required to produce a unit of power in the locomotive or other steam engine, there will be new inventions developed with the hope of capturing the profits that ought to be given to those whose devices prevent

wasted effort. There seems to be something very alluring in the work of attempting to make improvements on valve motion. It resembles the craze for gambling or that of indulging in stimulants. Among the men mentioned as working to improve the valve motion, some were veritable martyrs to their ambition. One in particular, who held an excellent position, became so infatuated in developing valve motion combinations that he ruined his usefulness as a railroad official and went to a premature grave protesting against the short-sightedness of those who had withdrawn their support of what they called his wild vagaries.

### Combined Link and Cam Motion.

In 1866 the valve gearing shown in Fig. 220, which was designed and patented by Messrs. Uhry & Luttgens, was applied to an engine built by Rogers for the Central Railroad of New Jersey. In this there was an ordinary shifting link worked by two eccentrics and connected with a pin attached to the lower arm of a rocking shaft in the usual way. What may be called a supplementary rocking shaft,  $R, R'$ , was pivoted to the top pin of the main rocking shaft. The lower arm  $R'$  of the supplementary rocking shaft was bent into a half circle, as shown, in order to clear the main rocking shaft  $M$ . The supplementary rocker was worked by a cam  $O'$ , which was connected to a pin  $P$ . The effect of the action of the cam was to accelerate the movement of the valve at the time that it opens the ports for admission and exhaust. Its adjustment gives about 50 per cent. greater opening of steam port. The point of exhaust is retarded from 5 to 6 inches beyond the link motion, while the point of compression remains the same. The size of opening of the exhaust is somewhat larger than with the link motion, and it is opened in less time, thereby producing a strong and clear exhaust.

This motion gave a quick port opening, delayed but sudden release, and provided about the proper amount of compression, but it was not applied to a second engine.

### Corliss Valves on Locomotives.

The valve and gear shown in section in Fig. 236 is an adaptation of the Corliss principle to suit the requirements of locomotive practice. It was designed by Mr. O. W. Young and consists of two valves for each cylinder, operating alternately as inlet and outlet and driven by the Corliss wrist motion, used in connection with the Williams shifting link. An original device is provided for

correcting the irregularities in lead and either a constant or a slightly increased steam lead for the shorter cut-offs can be obtained, and an excessive pre-admission of steam avoided. The exhaust lead by this device is caused to increase as the cut-off is shortened and permits an exhaust lap for long cut-offs, changing to exhaust clearance for a short cut-off.

The valves consist of cast iron strips outside the exhaust cavity and partitioning the live from exhaust steam. The strips are free to move towards or from their seats, and are independent of each other. Each strip follows its own individual path of travel and adjusts itself to any irregularities in the seat over which it moves. The valve body or carrier is journaled at each end and its weight is supported entirely clear of the valve seat, the only weight on the seat being that of the strips.

### Alfree-Hubbell Gear.

In this gear the valve seat is tilted about  $15^{\circ}$ , thereby providing for the use of one end of the valve, as well as the valve faces, for admission and exhaust; and there is also an independent valve for controlling the exhaust, practically making it equivalent to a four-valve engine with only two ports to the cylinder. No auxiliary motion is used, the cylinders are bolted to the smoke door in the usual way and the valve stem is connected to the existing valve motion of the locomotive, be it Stephenson, Walschaert, Stevens, Joy, or any other motion which gives a movement to the valve parallel to the line of the cylinder axis. The exhaust valves are  $1\frac{1}{4}$  inches less the distance over all than the main steam valves. In the dash pot connection between the main steam valve and the exhaust valve, a movement of  $1\frac{1}{4}$  inches is provided for, so that when the main valves open for exhaust, the independent exhaust valves open at the same instant and with exactly the same movement as the main steam valve, so that when the exhaust takes place there is an additional area of exhaust port opening equal to the area of the independent exhaust valves, and which are 5 inches in diameter, and this arrangement secures a considerably increased port opening, thus giving a very free exhaust of the steam from the cylinders, reducing back pressure, and the final closure of the exhaust port is delayed until late in the stroke through the dash pot connection between the main steam valve and the exhaust valves. Increased expansion is secured by giving about  $7/16$  of an inch exhaust lap to the main steam valve.

### Apology.

This is a long treatise on the single subject of valve motion, but I am in hopes that it may be valuable to future students of locomotive engineering, to the class of men who are interested in studying the history of all details of their profession. It may also be useful to the class who are constantly searching the ruins of past achievements for things to be worked up into new and useful inventions.

### A Mystery of Steam Performance.

We often hear surprise expressed that some of the ingenious valve motions invented to overcome the well-known defects of the link and other valve motions of equivalent shortcomings do not

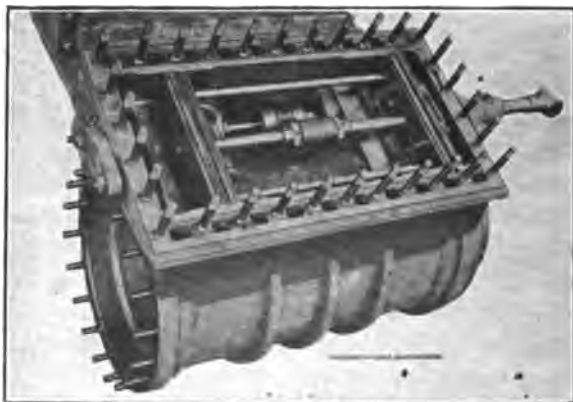

Fig. 237. Arrangement of Allfree-Hubbell Valves

obtain the favor and patronage of railroad companies. Their friends will point to indicator diagrams taken from the improved valve gear and say there is a figure that cannot lie. Nevertheless, the beautiful indicator card conveys false witness in locomotive practice. For an ordinary engine, where the steam is not employed for draft induction, meeting the requirements of high initial pressure, steam line maintained to point of cut-off, clear cut-off or quick release with absence of back pressure, compression only sufficient to meet equal admission pressure indicate perfect distribution of steam. That an engine producing a diagram that looks like a small picture of a leg of mutton should use less steam per unit of work than that of the perfect diagram seems absurd, yet it is very often true. Why this should be thus must be searched

for in the mysteries of draft production and in the peculiarly exposed cylinders and steam passages of locomotives.

Study of the valve motion of locomotives impresses us with faith in the poet's lines that

"There are more things in heaven and earth, Horatio,  
Than are dreamt of in your philosophy."

As there has recently been a great revival in America favoring the use of the Walschaerts valve gear, I use the text and illustrations of a paper presented to the New York Railroad Club on

### The Walschaerts Valve Gear as Applied to Locomotives.

BY JAMES KENNEDY.

Thirty years ago, at the Centennial Exhibition at Philadelphia, there was a little locomotive pulling a train of small cars about the

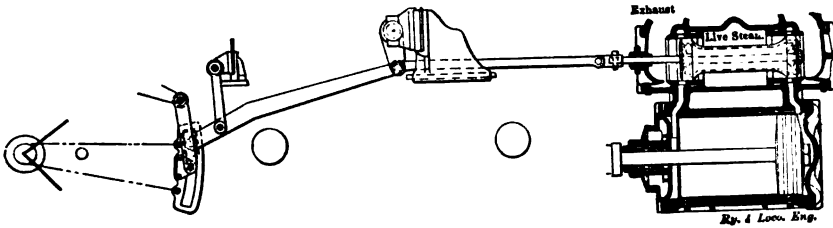

Fig. 238. Example of Direct Motion, Inside Admission Piston Valve

grounds on a narrow gauge track. It was little more than a toy. It was built at the Mason Machine Works at Taunton, Mass. The valve gear consisted of a crank attached to the main crank pin, which, by an adjustable rod, moved an oscillating, radial link suspended at the back of the guide yoke, which in turn moved the valve rod. A spider-like connection with the cross-head added another novelty to the contrivance. It performed the work of opening and shutting the steam ports correctly, but it attracted little or no attention. It was said to have been in operation on locomotives in Europe, and it is a remarkable circumstance that it has not, until quite recently, been used to any extent either in the United States or in Great Britain.

Probably had American locomotives remained about the same size as they were at the time alluded to, little more might have been heard of the Walschaerts valve gear on this side of the Atlantic. The increase in the size of the locomotives and the fixed distance between the rails has rendered the use of the so-called Ste-

phenson shifting valve gear, with its heavy and multiplex parts, in the narrow space between the frames, extremely difficult of access and inspection. With axles a foot thick, and four wide eccentrics, the bearing surfaces of which describe a circle seven or eight feet in circumference, the limit of mechanical possibilities, in such a space, has been reached, and the adoption of a system of valve gearing having its entire mechanism outside of the engine frames has become a physical necessity. American ingenuity has not been idle in endeavoring to find a solution of this problem, and it is surprising that amid the various contrivances that have been experimented with, this beautiful and almost perfect piece of mechanism, now coming into popular favor here, has so long lain aside, as it were, waiting to be called into service. Invention generally follows necessity. In the case of the Walschaerts valve gear it seems to have preceded it.

### The Stephenson Valve Gear.

The Stephenson valve gear has never been other than a cumbersome, loose, and, consequently, more or less unreliable mechanical contrivance. The necessary looseness of rapidly revolving eccentrics shaken by vertical vibrations, increases the error made by eccentric rods transmitting their angular, and therefore irregular, motion to the radial link which readily lends itself to lapses in motion, incident to its long angle and resultant slip of the link block. These in turn convey their increased system of variations to the sliding valve, the exact varying velocity and path of which, in its reciprocating eccentricities, is past finding out.

When we consider the variety of joints through which the motion has passed, from fifteen to twenty in number, with their incessant lateral shocks, it is not to be expected that the moving valve at the remote end of these loosening joints could be made to maintain its place at the same relation to the position of the piston for any considerable length of time. In locomotives where the eccentrics are attached to the main driving axles, the conditions are not so deplorable as is the case where the eccentrics are attached to another rod-connected pair of drivers. Their loose joints seem to lend themselves willingly to the multiplication of error, and so common is this that the variable exhaust, giving vehement vocal utterance to the sad story of unsteady volume and irregular time, falls, generally speaking, on inattentive ears.

### The Walschaerts Valve Gear.

Coming to the question before us of the use of the Walschaerts valve gear as applied to locomotives, it may be said in a general way that the absolute perfection of mechanism, as in the perfection of art, eludes and ever will elude the seeker after the ideal. The contrivance is not altogether perfect in its movement as no motion ever can be that depends on rotary motion being changed into lineal motion by the use of connecting rods. However limited the path of the crank may be, a certain brief space is lost in the first half of the stroke to which its equivalent is added in the second half. In a reversing engine this variable motion will always be a factor of disturbance in all calculations, but it can be justly said that in the Walschaerts valve gear the difficulty can be rendered of as little effect as can be looked for in any mechanical movement of mere human invention.

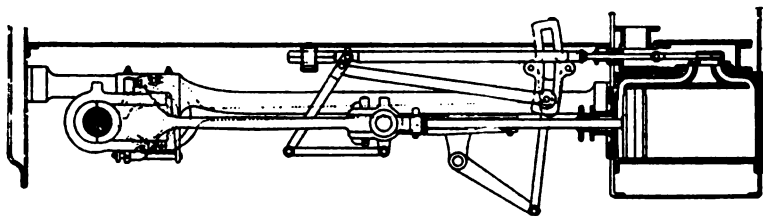

Walschaerts Variable Expansion Valve Motion Applied to Locomotive  
No. 98, Brussels, Belgium, 1848

The perfect adjustment of the eccentric crank at right angles to the main crank to which it is attached is the primal necessity in the construction of the gearing. It can readily be seen that a connecting rod attached to a crank so fixed would convey a motion to the ordinary sliding valve which, if correct in point of length, would place the valve in the center of the valve seat when the piston would be at the end of the stroke. With the lap and lead necessary for the economic use of steam, it is a simple question of how far the valve should be removed to reach the desired point. The moving of the valve to this point is the distinct and crowning feature of Walschaerts' masterly invention. The valve rod is engaged by an intervening union bar which is attached to the cross-head, and the co-relation of the short distance between the union bar and the bar driven by the eccentric rod and radial link, and the lower end of the union bar, becomes the determining factor in

moving the valve away from the central position to the point desired.

This is not all. The action of the intervening union bar is such that at the opening of the valve the motion is accelerated, and a rapid opening at the end of the stroke of the piston becomes a peculiarity of the valve's motion, in addition to which the opening becomes a fixed quantity unchanged by the variations of the valve travel. Adding to this the fact that the intervening radial link os-



James Kennedy, Who Has Given Valuable Help on  
Investigation of Valve Motion

cillates in a much smaller arc than is the case with the Stephenson valve gear, it can readily be seen that the regularity of the movement is at all times under perfect control and the path of the valve can be defined with a degree of exactness that leaves little or nothing to be desired.

It may be remarked that the number of joints are generally about half the number used in the Stephenson valve gear. These joints have the superior advantage of being nearly all in a position



that affords an opportunity for massiveness of construction with broad and ample bearings and bearing surfaces calculated to drive without strain the valve spindles of the largest kind of valves. The pivots of the transverse rocking levers can be made of great depth and the free ends of the levers can be doubly linked, and in regard to the pivot bar or lead lever, as it should be called, connecting with the crosshead, it would be well if it were so constructed as to embrace both sides of the cross head and so avoid any pressure that is not acting in the same plane with the motion of the valve spindle. The whole mechanism can readily be constructed so as to avoid all angular stresses, which is impossible in the case of locomotives having their valve gearing inside while the valve rods are at a considerable distance outside of the frames.

With regard to the construction and proportion of the various

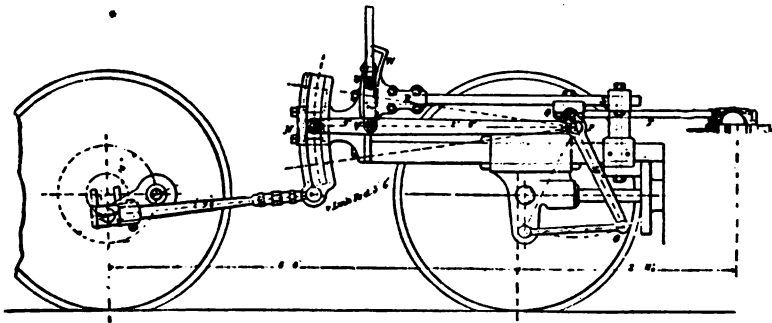

Walschaerts Valve Gear, as Applied to Locomotives by William Mason

parts of the gearing, it need hardly be stated that with given dimensions as to the distance from the center of the cylinder to the center of the driving axle to which the main rod is attached, with the length of the piston, and extreme valve travel, it is no very difficult task to design the various parts correctly, and if carefully fitted the gearing has the immediate advantage of being correct or so nearly so that a slight change of the length of the valve rod, which can be readily adjusted by the stem of the valve spindle terminating in a double-nutted end with lock nuts on the valve crosshead will have the effect of rectifying any variation. To this easy regulation of the central position of the valve can be added the ready adaptability of the eccentric rod to be shortened or lengthened by an adjustable turnbuckle or other simple device. The same flexible adjustment could be attached to the crosshead

combination rod. Indeed, the conditions and location of the parts lend themselves readily to the correction of any slight error that may arise in the construction and all multitudinous details of ordinary valve setting with its accompanying tediousness of experiment with the location of the link saddle pins, will, with the general adoption of the Walschaerts valve gear, pass into history and happily become a forgotten art.

### Comparative Tests of Valve Gears.

Among the locomotives furnished with the Walschaerts valve gear in use in America, it may be stated that in the records made by two locomotives on the Lake Shore and the Michigan Southern Railway, one being furnished with the Walschaerts and the other with the Stephenson valve gear, the lost motion incident to the ordinary wear of the latter in running a distance of a little over 30,000 miles was found to amount to five-sixteenths of an inch as shown by moving the valve spindle longitudinally, while in the former, with a record distance approaching 40,000 miles, the lost motion barely amounted to one-sixteenth of an inch.

It has also been shown in one of the largest locomotive works in America that in the construction of twenty-five locomotives fitted with the Walschaerts valve gear, the location and movement of the valves did not vary more than one sixty-fourth of an inch except in two instances where a variation of three sixty-fourths was discernible owing to the unavoidable contraction of the radial link in the process of hardening. The variation involved a shortening of the eccentric rod, to which, if some kind of flexible adjustment could be given, the valves could readily be kept in their proper positions even after the hardened bearings had begun to show indications of inevitable wear.

In the element of comparative weight the Walschaerts valve gear can be made with massive bearings and still be less than half of the weight of the Stephenson gear, while the liability to breakage is reduced to a minimum. In accessibility and convenience for inspection, alteration, repair or lubrication, the entire mechanism is as readily reached as the guides or connecting rods are; and in the event of the eccentric rods being fitted with an adjustable contrivance for shortening or lengthening the rod, or even with double rod keys at the crank connection, there is no reason why the gearing could not be easily maintained in its correct position as long as the locomotive was capable of running.

### Other Improvements.

It is reasonable to suppose that a general adoption of the use of the Walschaerts valve gear on locomotives will lead to many other important changes and improvements. The frames can readily be better braced and the entire engine can be constructed with a greater degree of compactness and symmetry. The shell of the boiler might be brought considerably nearer to the axles, particularly on locomotives of the Atlantic and Prairie types, where the ash pan can be conveniently placed between the driving wheels and the back trailers. The lowering of the boiler might admit of a further increase in the size of boiler, for if the limit of height has been reached, there is no reason why the space between the boiler and driving axles could not be utilized in response to the continued call for heavier and stronger locomotives.

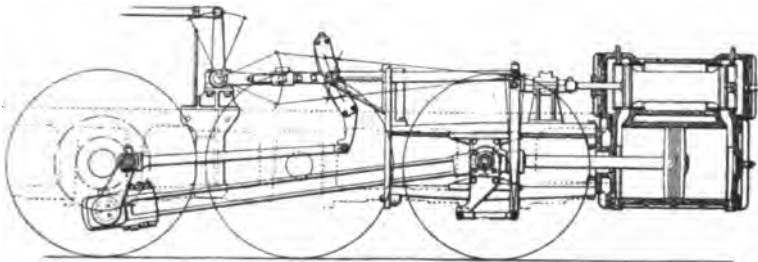

Walschaerts Valve Gear Used by American Locomotive Company

Such in brief are some of the advantages to be derived from the use of the Walschaerts valve gear as applied to locomotives. It meets the growing requirements of the situation with a higher degree of adaptability than anything hitherto in operation. Its more general use cannot fail to lessen the liability to accident so common to all machines where eccentrics are running at high velocities. The tendency of the straps to become heated and fractured increases with their increasing peripheral dimensions, and has become a constant menace to locomotive running. The reversing lever is becoming something terrible to touch, but with the Walschaerts valve gear it becomes easy of manipulation, and it should be a matter of general satisfaction among railway men that the constantly expanding requirements for more mechanical appliances used on railways has received another addition of great value, not new it is true, but newly recognized, like the corner-

stone that the builders despised, or rather like the fabled fountain of Arethusa that disappeared in the grosser elements of the earth to rise again beyond the seas with fresher brightness of beauty and perennial newness of life.

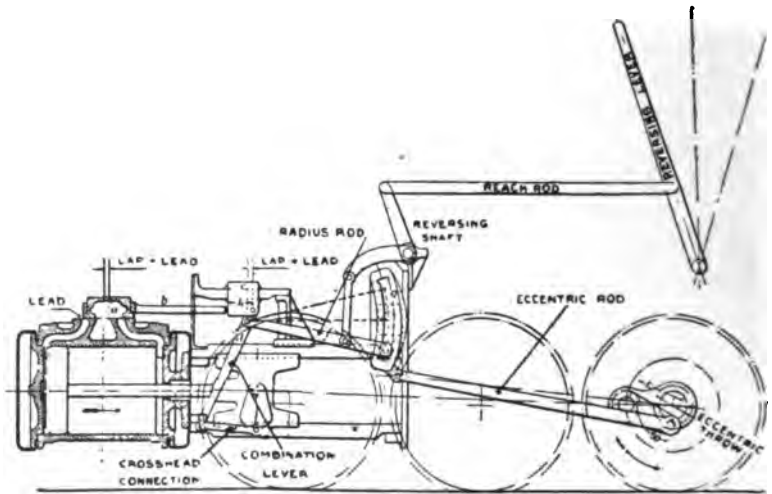

Walschaerts Valve Gear Used by Baldwin Locomotive Works

# Freaks and Curiosities in Locomotive Designs

## CHAPTER XXVII.

### The Enterprising Inventor.

The man who ventures to stray from the familiar beaten path may stumble into a quagmire, but he may have the good fortune to discover a vein of rich ore which the beaten path would never reveal.

When an inventor scorning the common forms proceeds to work out new and original shapes for himself, he may produce something which is ridiculous and impracticable, but even when he does that, the enterprising person deserves praise, for it has been



Fig. 239. Brunton's Traveller, 1813

by departing from other people's lead that new and original inventions have been given to the world.

In publishing a chapter on Freaks and Curiosities in Locomotive Designs it is not done in a spirit of levity, but to give a record of well meaning inventions that did not perform the functions the inventors expected.

For the first twenty years after Trevithick built his locomotive, a belief was common that plain wheels would not adhere to the rail with sufficient tenacity to induce propulsion. It had happened that Trevithick's engine was what has become known as over-cylindered, the effect being that the engine was furiously slippery

Other pioneer locomotives suffered from the same defect and remedies were invented which now appear to be ridiculous.

### The Mechanical Traveler.

The most notable invention of this kind is illustrated, Fig. 239, and was known as Brunton's Mechanical Traveller. Brunton was aware that the action of the horse up to that time had been the most successful means of hauling vehicles, and the question arose, why not utilize the action of the horse mechanically? The engine was duly built to put that idea in practice. It had a horizontal boiler and a single cylinder set on top with piston connecting with levers that acted the part of a horse's legs.

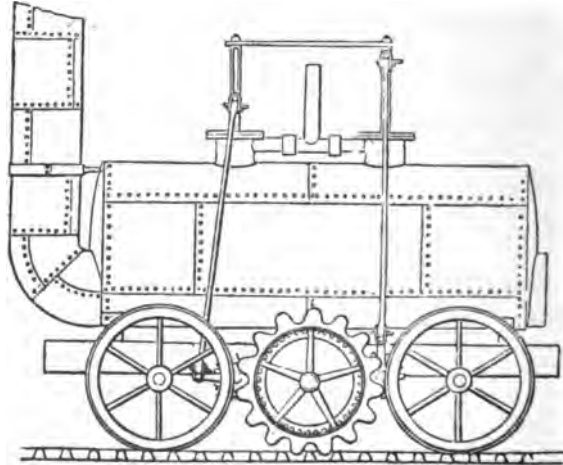

Fig. 240. Blenkinsopp Cogwheel Locomotive

The invention excited much attention. It had the merit of acting as the designer intended it should, and one day that it was on trial, rushing along at a speed of three miles an hour, accompanied by a host of admirers, the boiler exploded, throwing hot water, pieces of iron, and disaster among the crowd. That ended the career of the Mechanical Traveller.

### Cogwheel Locomotive.

The first attempt to overcome the deficient adhesion of plain iron wheels on plain iron rails was made in 1811, by J. Blenkinsopp, who obtained a patent for a self propelling steam engine, Fig. 240, worked by a cog wheel engaging a rack rail, a practice now common on mountain railways.

This Blenkinsopp engine was the first locomotive to perform profitable traction work. It was well designed for the time, having two cylinders 8 x 20 inches, set partly into the boiler and transmitting power to right angle cranks which drove the toothed driving wheels. A sensible feature about this engine was that the piston crossheads worked in guides instead of being controlled by parallel motion, as the pistons of most early locomotives were. The engine was used for about twenty years.

### Tentative Evolution.

In the course of evolution a variety of locomotives were built resembling Hedley's Puffing Billy, but they followed the line of improvement that led to the Rocket in 1829, which established the elements of a permanent type. In Great Britain there were not many departures from the form of the Rocket.

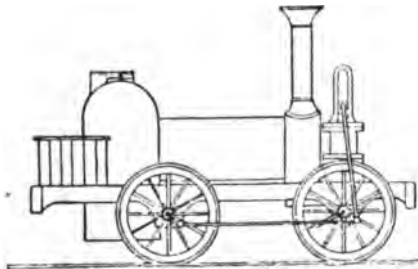

Fig. 241. Galloway's Caledonian

An engine called the "Caledonian," Fig. 241, was bought by the Liverpool and Manchester in 1832. The vertical cylinders were secured in front of the smoke box, with piston rods working through the upper cover to connecting rods that extended down to the driving wheels. That engine displayed a weakness for jumping the track, and was changed after a few months of service. Its *only* service to railways was emphasizing the mistake of using vertical cylinders.

### Roberts' Bell-Crank Locomotive.

About the same time Richard Roberts, who afterwards became a noted locomotive builder, brought out what he called the "Experiment," Fig. 242. That engine had vertical cylinders operating bell cranks which drove rods connecting with crank pins outside of the driving wheels. This engine had piston valves. It was used only for a few months.

Similar locomotives were built for the Dundee and Newtyle Railway, in Scotland, one called the "Earl of Airlie," having attracted considerable attention, which did not save it from alteration after a short career.

This bell-crank method of transmitting power to the driving wheels has been used successfully for special forms of locomotives in which it was not convenient to transmit the power direct. The real difficulty with Roberts engines and those made for the Newtyle Railway seems to have been in the piston valves, which were crude devices.

### Immense Driving Wheels.

Isambard Brunel, chief engineer of the Great Western Railway, of England, who made the gauge of that railway seven feet wide, had a predilection for large sizes among them large driving wheels. An engine shown in Fig. 243, had driving wheels 10 feet in diam-

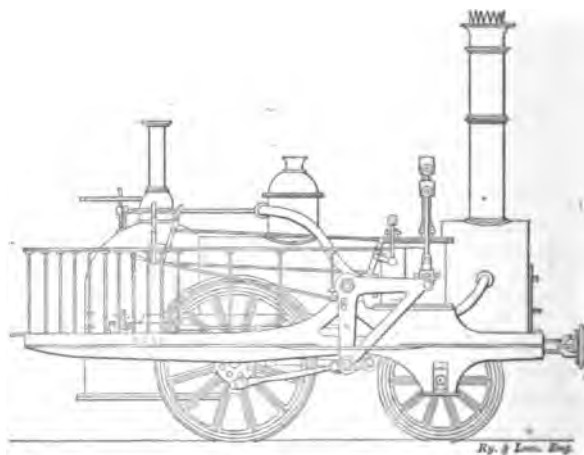

Fig. 242. Roberts' Experiment, 1833

eter. About the time that engine was built the Great Western Railway received one of the kind shown in Fig. 244. The latter was made according to the Harrison patent, which called for driving wheels being secured on one set of frames, the boiler being carried on another set. The science of mechanical engineering was in its infancy in those days, yet one marvels how the designer of such a locomotive expected to obtain the necessary adhesion.

A similar engineering blunder was made a few years later in the United States, when G. A. Nichols, <sup>superintendent</sup> superintendent of



the Philadelphia & Reading Railroad, had built a locomotive with the boiler carried on a frame separate from the engine. Mr. Nichol's idea was fairly rational, however, for he was trying to make a boiler with grate surface sufficiently large to burn anthracite coal. Harrison departed from prevailing practice in order to apply abnormally large driving wheels.

The inclination to use huge driving wheels was based on the fallacy that the size of the driving wheels measured the speed possibilities of a locomotive. It took years of experience to demonstrate that the boiler was really what controlled the speed. Some of the high wheel Crampton locomotives, built in Europe and in the United States, such as that shown on page 94, had the boilers so small that want of steam reduced the speed before the train had gone five miles, if high speed was attempted.

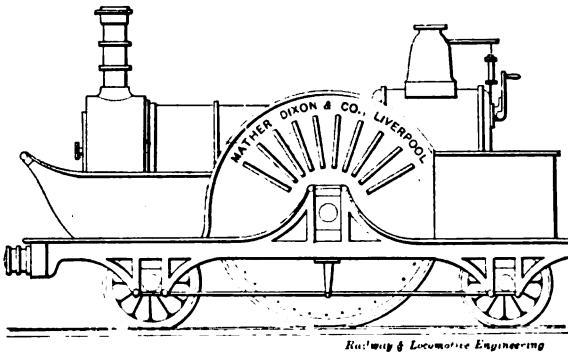

Fig. 243. Early Great Western Locomotive, with Driving Wheels Ten Feet Diameter and Wind-Splitting Front End

### Indirect Driving.

Although it is a recognized physical axiom that in locomotive engineering a pull or thrust is most effective when worked horizontally, the fallacy of vertical or inclined cylinders influenced the design of locomotives for many years. Many attempts were made to increase power by means of intermediate driving axle arrangements of the type illustrated in Fig. 245. A very interesting attempt of this kind is illustrated in "Sekons Evolution of the Steam Locomotive." This engine was built at Bradford, England, for the Cambrian Railway. It was a vibratory engine, the special merit claimed for the arrangement of mechanism being that it produced perfect balance of the reciprocating and revolving parts. I wonder that the hammer blow alarmist never tried this engine.

The driving axle was secured between the frames and set parallel to the wheel axles. The driving axle was secured at each end to a strong disk which held power transmitting mechanism. The pistons, which were fan shape, drove rocking shafts secured to the driving axle and it in turn vibrated the disks to which the main rods were secured.

It was an ingenious engine and is reported to have done good service on small cost for fuel and repairs.

Locomotives driven through a supplementary driving axle were very common in the United States, but they were used mostly in the process of evolution. All the Baltimore & Ohio grasshopper engines were driven in this way and they worked quite satisfactorily. The Camden & Amboy monster, shown in Fig. 90, had heavy spur gears on the axles of the middle pairs of wheels which engaged with an intermediate gear performing part of the work done by coupling rods.

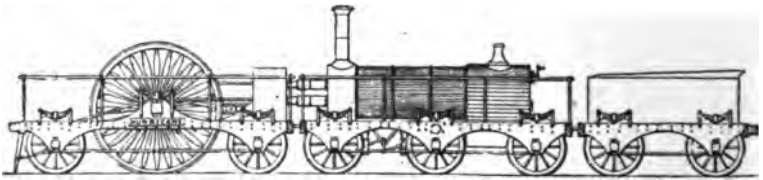

Fig. 244. Harrison's "Hurricane"

When locomotives of that character have been built by men seeking for the best form of engine to perform the work of train hauling, their efforts were commendable, but at various times amateur locomotive designers, saturated with egotism and personal conceit, have produced ridiculous engines and sometimes their friends have tried to force them into use through stock-selling operations. A notable case of this character was the Raul Central Power locomotive, Fig. 246, built at Paterson, N. J., in 1892. The people interested in this invention tried to push it through the influence of sensational articles in the daily newspapers, their claims for speed and efficiency being senseless exaggerations, but their efforts were in vain. As usual, they blamed its unpopularity upon the prejudice of railroad men and the engineering press. The engine had two small boilers, each with a fire door on each side and a smoke flue going back to a stack in the center. Vertical cylinders were employed, transmitting the power through a central shaft. This

engine was not only an oddity, it was a fake of the worst kind. Instead of an advance in design, it was returning to pioneer practices, being a product of combined ignorance, egotism and perversity.

Ever since people became inventors of mechanical appliances, there have been persistent attempts made to overcome the laws of nature by arrangements of mechanism designed to produce perpetual motion. In some instances inventors labored to produce apparatus that would maintain motion of their own unaided volition, others labored by combinations of mechanism to gain power by leverages or their equivalents.

Of this class of invention was the Harrison locomotive, shown in Fig. 247. In this engine the real driving wheels, which had geared peripheries engaged with cogs on the rail wheel axle.

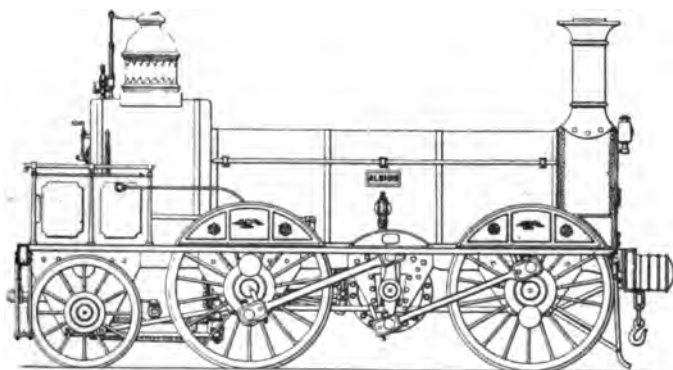

Fig. 245. "Albion," Built for Cambrian Railways

The expectation was that excessive speed could be maintained with reduced expenditure of power, as the piston speed could be regulated at what the engineers of the time considered most conducive to economy of steam. The engine shown was built by Hawthorns of Newcastle, in 1837, the gearing being 3 to 1, so that one revolution of the driving wheels caused the rail wheel to turn three times. The "Hurricane" was used a short time on the Great Western Railway, and was said to have maintained a speed of 100 miles an hour, but that did not preserve it from premature demise. Harrison's failure did not discourage others from trying similar experiments.

The inventive habit has been cultivated for many years in the United States through liberal patent laws that enable an inventor

to enjoy the fruits of his ingenuity. Owing to this there is an army of ingenious men ever ready to improve on foreign inventions, with the result that a mechanical oddity appearing in a foreign country soon appears on this side of the Atlantic in exaggerated form. The Harrison two story locomotives had several imitations in America.

### The Fontaine Freak.

In 1881 the Grant Locomotive Works, of Paterson, N. J., built a locomotive, Fig. 248, designed by Eugene Fontaine, of Detroit, which excited great attention for a few years owing to the radical departure from established practice in designing locomotives. Fontaine built his engine with the driving wheels above the boiler, so arranged that their tread pressed upon and transmitted motion to the carrying wheels by frictional contact. The reasons given by the designer for building this form of an engine were: "The question of faster speed in railroad travel is one that is now

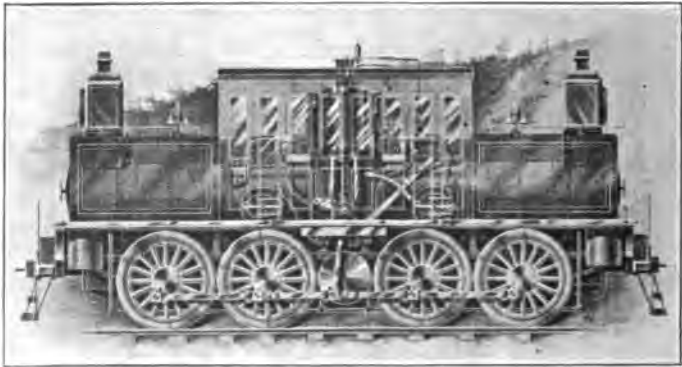

Fig. 246. Raul Central Power Locomotive

attracting attention on the part of the public, who demand it, and of the railroads, who are anxious to meet the demand.

"It is well known that to increase speed in locomotives, as now used, beyond a certain rate, can only be done by an increase of steam pressure, which can only be obtained by increased expenditure of fuel, and such an expense increases in a tenfold ratio to the increased rate of speed obtained, to say nothing about the additional strain upon the boiler."

To overcome these imaginery deficiencies the locomotive with two driving wheels set up in the air above two other driving wheels that rested on the rails was built and put in service. There was con-

siderable discussion on the invention, but there were very few engineers who believed that any advantage of steam or economy could be secured by the wheel arrangement adopted. Their judgment was vindicated by the results of practical service. The engine was tried on all kinds of trains, but proved inferior in every respect to the ordinary engines of the same capacity. The engine was examined as a curiosity in a variety of roundhouses for a few years. There was always something needed to make its work satisfactory. After many changes, the proper one was made when it was converted into an ordinary eight wheel engine.

### Holman's Absurdity.

It might have been supposed that the Fontaine experiment would have deterred others from trying such an expensive experiment again; but when an amateur gets seized with the malady for

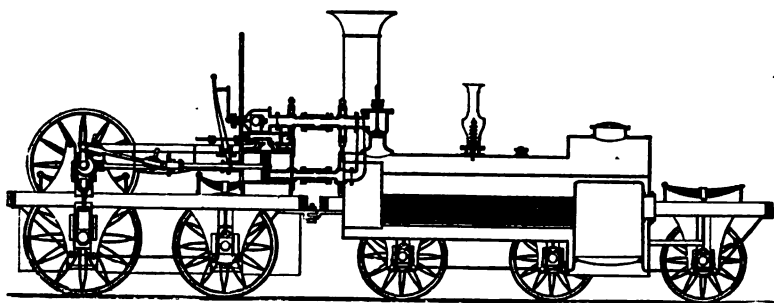

Fig. 247. Harrison's "Thunderer"

designing a locomotive of an entirely new pattern, he generally produces something startling.

In 1887 The Holman Locomotive Company had built in Philadelphia the locomotive illustrated in Fig. 249. I was immediately assailed by practical railroad men and others for my opinion of this, the latest monstrosity. I had not seen even a picture of the engine, but descriptions were freely written. My opinion, expressed in *Locomotive Engineering*, was: "It is a humbug. It is sound engineering to hold that every piece added to a machine, after it has reached the practical stage, is a source of weakness. A triple set of wheels under a locomotive would be proposed only by one who is densely ignorant of mechanics."

Next notice in the same paper reads: "There appears to have

been some method in the madness of the parties who got out the absurd Holman locomotive.

"They are advertising in Philadelphia papers that a company has been formed to sell this kind of locomotive, the capital stock being \$10,000,000. They offer to sell the stock for \$25 a share, the par value being \$100. They make the claim that this sort of engine is destined to be the locomotive of the future.

Next notice, also in the same paper, reads: "The parties exploiting the Holman locomotive are advertising their stock in numerous newspapers, and claiming that the invention is certain to come rapidly into general use. The effect of that has been that



Fig. 248. Fontaine Locomotive

numerous letters have come to us asking our opinion of the thing. We gave a general answer, the first paragraph of which reads:

"When we first heard of the Holman locomotive we supposed that it was the invention of some harmless crank who did not understand the elementary principles of mechanics, but we now believe that it has been, since its inception, an ostentatious machine designed to allure unwary capitalists into an investment which will be of the same real value as throwing gold coin over Niagara Falls."

The engine was run a few trips on a straight railroad in New Jersey, which was used merely as a stimulant to stock selling. Unfortunately many people with limited savings were allured into

investing their hard earned money in this swindle and they might as well have given it to a highway robber.

One painful case that was pushed to my attention will illustrate the danger of taking stock in things recommended by friends. Mrs. Marion French had sufficient money in United States bonds to produce her an income of \$570 a year. Some idiotic friends advised her to invest in the Holman Locomotive Company's Stock, assuring her that she would more than double her income without risk. Our washerwoman never loses a chance to ask me when the Holman Locomotive Company will begin paying dividends.

### The Austrian Duplex.

There is no question that destructive blows are imparted to the rail from the unbalanced weights of the driving wheels. Inventors



Fig. 249. Holman Locomotive

were early in the field to eliminate this blow by an opposing force, and, incidentally, to make a smoother working engine. This idea brought forth in Europe the Haswell locomotive, shown in Fig. 250. That engine, which was built in 1861, at Vienna, for the Austrian State Railway, excited much attention at the International Exhibition of 1862, where it was exhibited. The engine had two cylinders on each side, the power from the pistons being transmitted to crank pins diametrically opposite to each other, the expectation being that the momentum of each set of reciprocating parts would balance the other set.

The "Duplex," as the engine was called, was very powerful for that day, the cylinders being  $10\frac{7}{8}$  inches in diameter with stroke of  $24\frac{7}{8}$  inches. The driving wheels were 81 inches diameter. There were fifteen square feet of grate area and the heating surface

was 1,344 square feet. The designer of this engine expected that it could be run with absolute steadiness, at excessively high speed, and the reports made of its performance in train service justified the belief concerning steadiness, but the advantage gained was not considered of sufficient importance to justify the repetition of the experiment.

The railway world had not begun talking about the so-called "hammer blow" in 1862, but the unsteadiness of many locomotives at high speed made itself manifest and various schemes were resorted to for the purpose of remedying the defects which was largely due to bad counterbalancing of the driving wheels. The patent office records tell of many inventions being produced for making locomotives run steadier at high speed, but nothing of a permanent character has displaced counterbalance weights placed in the driving wheels.

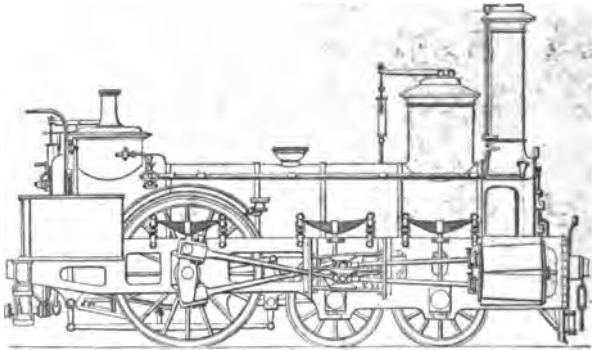

Fig. 250. "Duplex," Austria, 1861

During the iron rail period considerable ingenuity was devoted to inventions calculated to reduce the wear of rails, due to impact of the wheels. It was supposed for years that a low center of gravity saved the rails from destructive shocks. Years of experience demonstrated that a low center of gravity tends to lead the wheels into imparting destructive side shocks to the rails, but that was an article of knowledge that came to the railway engineering fraternity by very slow degrees.

#### The Shaw Four-Cylinder Balanced Engine.

In 1881 there was built at the Hinkley Locomotive Works, Boston, a four-cylinder balanced engine, called the H. F. Shaw,



Fig. 251, which was industriously exploited as being entirely free from the pounding and oscillating action of two cylinder locomotives. The locomotive was substantially the same as Haswell's Duplex, except that the cylinders were arranged side by side transmitting the power to crank pins diametrically opposite each other. One of the crank pins connected outside the driving wheel at the same position an ordinary crank pin would be located, and carried a double crank, the middle of which was supported in a bearing secured in an outside frame. That bearing was the driving fulcrum, a main rod working at each side of it.

The engine was equivalent to one with two cylinders 16 x 24 inches, and driving wheels 63 inches diameter. The weight in work-



Fig. 251. Shaw Four-Cylinder Balanced Locomotive

ing order was 74,000 pounds, of which 25,600 pounds was on the truck wheels. The boiler had 14.8 square feet of grate area, and 981.75 square feet of heating surface. The engine was well designed and built in first class manner. It was used to a considerable extent on train service in an experimental fashion, and worked quite satisfactorily.

The advantages claimed for the Shaw were: Perfect balancing, an increase in the area of wearing surfaces, and, by dividing the work between four cylinders, reduction of wear and tear was accomplished, and, consequently, less risk of accident.

One claim read: "By utilizing all the force developed upon the piston directly upon the driving wheels to rotate them, the enormous loss through friction in ordinary locomotives is entirely

avoided." The soundness of that claim is open to dispute and the other claims advanced are even more open to argument.

The Shaw did not languish unknown through want of advertising. A gentleman named William E. Lockwood had the exploiting of the invention at heart, and few railroad officials of any consequence failed to learn how the "hammer blow" could be entirely prevented.

Some of the locomotives designed with special view to securing low center of gravity are curious. Zerah Colburn was a sensible railway man, with a good practical training as a mechanical engineer, yet in 1854 he fell into the blunder of designing the absurdity shown in Fig. 252. That engine had a double boiler,

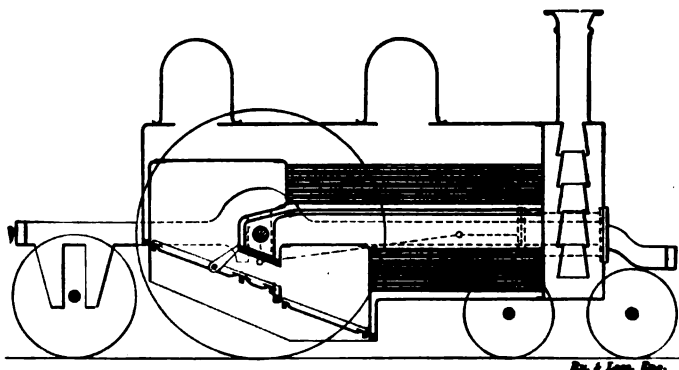

Fig. 252. Colburn's Design of Locomotive Double Boilers, with Driving Axle Between

43 inches diameter, arranged so that the driving axle was located between them. It involved the use of two fire boxes, besides two sets of tubes. The best that can be said about it is that it was a very courageous design, but it came to nothing.

The attempt to make big boilers with low centers of gravity is illustrated in Fig. 253, which shows Trevithick's "Cornwall" built in 1847. It was a very awkward arrangement and required a recess being made at the top of the boiler for the driving axle to pass through. In service it was found that the engine did not run any steadier than those with a much higher center of gravity did. The very low center of gravity is a fallacy so far as steady runnings is concerned because when the wheel in its revolutions receives sharp blows due to inequalities of the shock is delivered to

the side of the rail. When the center of gravity is high, like what it is in our Wootten engines, the blow strikes more on the top of the rail than on the side.

One of the principal oddities appears to be Crampton's "Liverpool," which was built in 1848, and is illustrated in Fig. 254. It has a huge single pair of driving wheels which was the Crampton peculiarity. The designer's idea of putting the driving wheels under the foot plate and the cylinders near the middle of the boiler was also the idea of getting a low center of gravity, and a comparatively big boiler. I had seen some experience with Crampton engines many years ago, and never saw anybody who had a good word to say about them, except those connected with the designing and building.

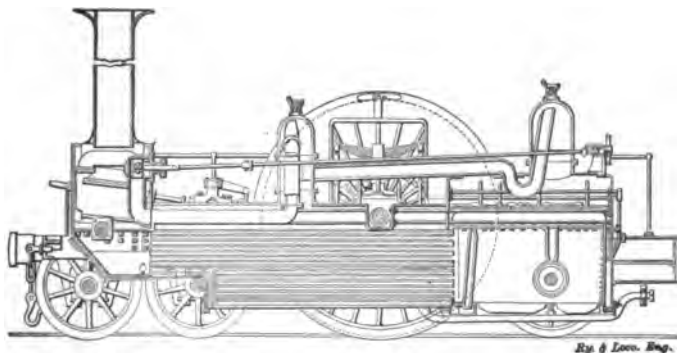

Fig. 253. Trevithick's "Cornwall," 1847

Fig. 255 shows interesting specimen illustrating the attempt to introduce enormously large driving wheels in Blavier & Larpent's engine "L'Aigle," built in France, in 1855. The engine was exhibited in the Paris Exposition of that year, and attracted a great deal of attention, but never did acceptable work in service. It had cylinders  $16\frac{1}{2}$  by 22 inch stroke, and driving wheels 2.85 metres, equivalent to 9 feet 4 inches diameter.

Another engine built and designed to obviate the disturbing force due to the action of reciprocating is illustrated in Fig. 256. This engine was patented by Stephenson and Howe, in 1846. The cross section looks like Webb's famous compound, but it was a small engine, and was intended to prevent the nosing action so well known with badly counterbalanced, outside connected engines. The middle cylinder was  $16\frac{3}{8}$  by 18 inches, and the out-

side,  $10\frac{1}{2}$  by 22 inches. The engine in service did not act as the patentees expected it would, and the type was never repeated.

### James Toleman Four-Cylinder Locomotive.

A most expensive sacrifice to good intentions was the "James Toleman," Fig. 257, another four cylinder locomotive, but decidedly different from the other two.

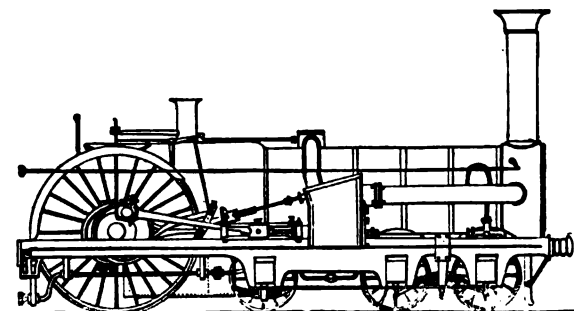

Fig. 254. Crampton's "Liverpool"

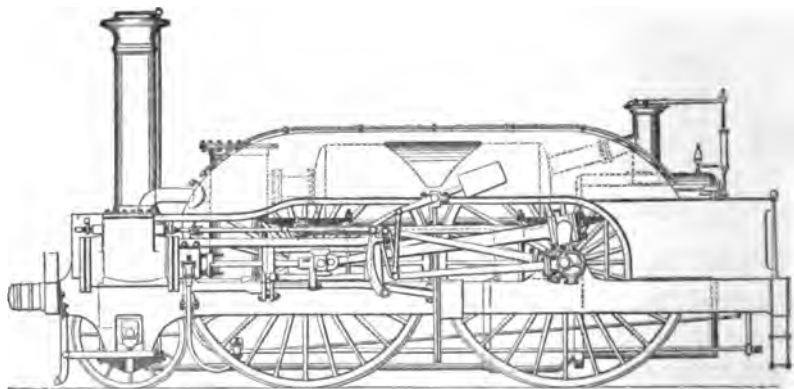

Fig. 255. MM. Blavier and Larpent's Engine, "L'Aigle," 1855

The James Toleman was exhibited in 1893, at the World's Fair, in Chicago, and it evidently was expected to create something of a sensation in this country. The engine represented the ideas of an English engineer as to the best form of locomotive for handling heavy fast passenger trains. It was designed by a Mr. Winby, of London, and was built by Hawthorn, Lester & Co., Newcastle, England.

That the engine was radically different from the ordinary locomotive was apparent to the most casual observer; yet there were many novelties about the machine that could be found only after laborious examination. To obtain high speed and great power combined, two pairs of driving wheels, 90 inches diameter, were employed, and each pair was driven by a pair of separate cylinders, the front drivers being driven by inside cylinders located under the smoke box, and the back drivers by outside cylinders set outside, back of the leading truck. The inside cylinders were 17 x 22

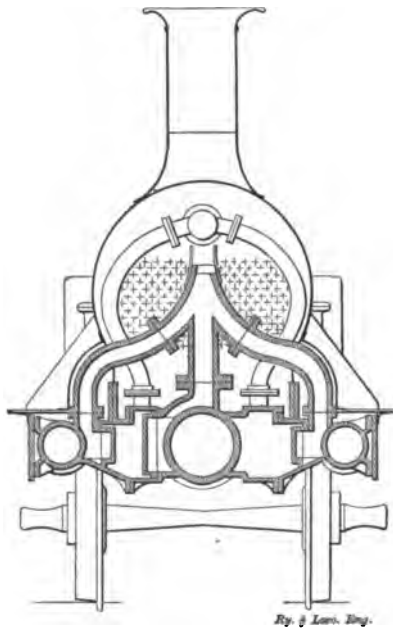

Fig. 256. Stephenson & Howe's Three-Cylinder Engine

inches, and the outside cylinders 12½ x 24 inches. A striking point about the outside connections was the long piston rod necessary to reach the guides. The most commendable part of this engine was the arrangement that obviated the use of parallel rods. A shifting link motion was used for the inside cylinders and Joy's motion outside.

The boiler was one of the most curious features of this odd locomotive. To obtain as much heating surface as possible while maintaining a fairly low center of gravity, the boiler was made

elliptical, narrowed in the middle of the horizontal diameter, so that it could be strengthened by cross braces.

A very serious objection occurred to me when I first examined the engine, which was the complication of parts and the difficulty that would be encountered in effecting repairs. I wrote: "The designer appears to have had no consideration whatever of the fact that repairs would have to be done frequently to a locomotive pulling fast heavy trains. The engine is very handsome and displays admirable workmanship. It has large bearings and strong connections; but we would not like to have the duty of keeping a number of them in working order."

After the exhibition was over the James Toleman was put upon the Chicago, Milwaukee & St. Paul Railroad, to haul ten parlor



Fig. 257. "James Toleman," 1892

cars 82 miles in two hours. It failed very decidedly on that service, both from lack of steam and through breakage of parts.

#### Fate of the James Toleman.

Replying to a letter of inquiry which I sent, Mr. A. E. Manchester, superintendent of motive power of the Chicago, Milwaukee & St. Paul Railway, wrote:

"The engine 'James Toleman' was some seven years ago turned over to the Purdue University, La Fayette, Ind., as a museum feature, and I believe is still there.

"As to the performance of the engine on our road will say that we never got any practical results from it at all.

"In the first place the grate surface and the size of the fire box

were not equal to the demands on the boiler, and no adjustment of the front end or exhaust appliances was equal to taking care of the demands on the boilers.

"You will remember that one of the features of this engine was that the flue sheet extended into the fire box. In other words, it was a combustion chamber reversed, and it was found in practice that all of the grate surface under this projecting portion of the cylinder part of the boiler would not burn the coal, consequently the grate surface was cut down to the limited amount that was between the end of the flue sheet and the back end of the fire box.

"The engine, as you no doubt remember, had four cylinders. The inside cylinders connected with a crank shaft to the front driving axle and was operated by a shifting link motion. The back cylinders were connected by a wrist pin to the back driving wheels and axles and were operated by a Joy valve motion. All of the cylinders drew their steam from one niggerhead and dry pipe, and the result of this was that whichever pair of cylinders, either inside or outside, took steam first, there was not enough went into the other cylinders to blow into the cylinder cocks, and it was only with a light throttle and moving slowly that all cylinders could be made to take steam at once. When but two of the cylinders were getting all the steam, the tractive power on that pair of wheels was not enough to take care of the work that the cylinders would develop, consequently the engine would stand and one pair of wheels would spin around like a circular saw and the others would be doing nothing.

"Mr. Winby, who was the designer and owner of the engine, stayed with it, and had his mechanical engineer and a special engineer whom he brought from England with him for something like two months, until he became thoroughly disgusted and went off and left it. We have not had a word from him for a number of years. I think he has forgotten that he ever designed or owned the 'James Toleman.'"

### French Favor Novelties.

France has given to the world a fair share of the freaks designed to send the ordinary forms of locomotives prematurely to the scrapheap, and, incidentally, to demonstrate what amateur designers could do in wandering away from well trodden paths of engineering rectitude. Gallic sentiment leans kindly to things that look new.

“The earth was made so various that the mind  
Of desultory man, studious of change,  
And pleased with novelty might be indulged.”

### Heilmann Electric Locomotive.

The Western Railway of France experimented persistently in 1897 with electric locomotives, Fig. 258, which generated the electricity in driving it. This form of engine was invented by J. J. Heilmann, a Swiss Engineer, residing in Paris. The first locomotive of that type tried was considered to work so satisfactory that two others, much more powerful than the first one, were made, one of them being the subject of illustration which was copied from the Railway World, of London. The body of the engine consisted of heavy steel girders which was carried by two eight wheel trucks. Above the rear part on the deck built upon the frames were placed the boiler and coal bunkers, while the

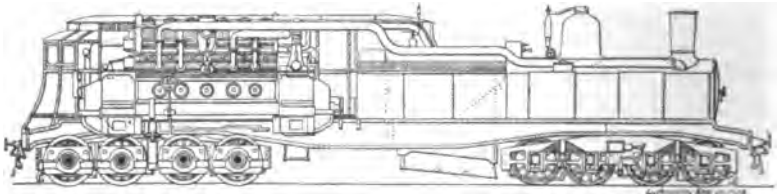

Fig. 258. Heilmann Electric Locomotive

principal steam engine, the two generation electric dynamos, the exciter with a special engine and the airbrake apparatus were carried above the leading truck.

The boiler was of the locomotive Belpaire type, and provided 1,996.5 square feet of heating surface. The grate area was 35.95 square feet. The boiler pressure carried was about 200 pounds to the square inch.

The engine was compound with six cranks set in a form that was reported to give perfect equilibrium. The engine drove two electric generators continuous current machines, independently excited. The current supplied by the generators was said to develop 125 horse power at 62 miles an hour. It was calculated that this locomotive would haul a train weighing 250 tons at the speed of 62 miles an hour, which seemed to me a small performance for the expense involved.



The Heilmann locomotive formed a spectacle to the people of Paris for only a few short months.

### Thuile Locomotive.

Another expensive French novelty was the Thuile high-speed locomotive, exhibited at Paris in 1900 by Schneider & Co., of Cren-sot, France, and shown in Fig. 259. That engine was designed to haul trains from 180 to 200 tons, equal to about four Pullman cars, at 75 miles an hour on level roads, and was calculated to develop about 1,800 horse power.

There were four coupled wheels, a full truck at the front and a six-wheel truck under the back end, although the necessity for this was not apparent, as there were only 59,000 pounds on this truck. This makes less than 10,000 pounds on a wheel for this

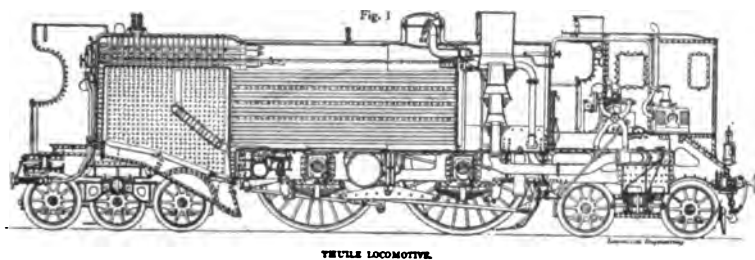

Fig. 259. Thuile Locomotive

truck, and under 15,000 for a four wheel truck, which would some preferable to the extra pair of wheels.

The driving wheels carried only 65,000 pounds, or about 16,000 on a wheel—but little more than was carried by the trailing truck. The total weight of the engine in working order was about 165,000 pounds, and the tractive power 15,652 pounds.

The boiler was of a flattened section, as shown, similar to the "James Toleman" boiler, to get it between the wheels, which were 8 feet  $2\frac{1}{2}$  inches diameter, and the method of cross-staying is shown in the sectional cut. The diameter of upper portion was about 54 inches, while the lower is 48.5 inches. The height was 79 inches. There were 183 ribbed tubes,  $2\frac{3}{4}$  inches in diameter and 14 feet 3 inches long, giving a heating surface of 2,941 square feet, which with 263 feet in firebox gave a total of 3,204 square feet. The boiler pressure was 213 pounds. The grate area was

very large for European practice, being a trifle over 50 square feet.

Cylinders were 20 x 27½ inches, and a Walschaerts valve gear was used. The total wheel base was 40 feet 2 inches, and entire length of engine, 46 feet. The cab, which had a wind-splitting attachment, was in front of the engine, while the fireman was at the rear—46 feet away.

The tender was also of peculiar design, having ten 42 inch wheels under it. The wheel base was 25 feet 7 inches, and the tender weighed about 49,000 pounds, empty, and 121,000 in working order. It carried about 6,000 gallons of water and 7 tons

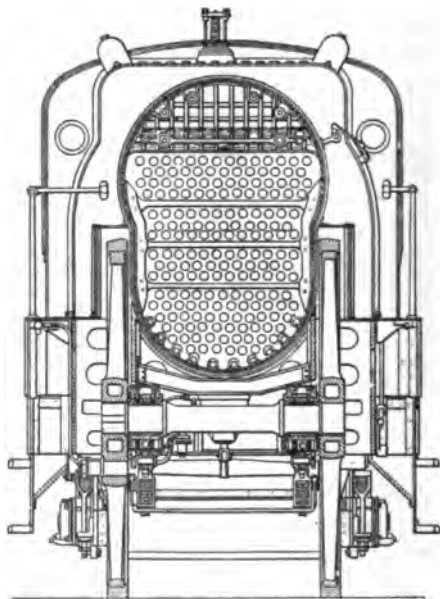

Fig. 260. Section of Boiler of the Thuile Locomotive

of coal. I was indebted to Engineering, of London, for the data given.

I examined that locomotive very carefully at the Paris Exposition and discussed its peculiarities with some of the most eminent engineers who were visitors at the show. The following conclude notes which I wrote to my paper about the Thuile locomotive:

“The engine shows traces of very careful designing and the construction work has been wonderfully well done. I listened to several well-known European engineers discussing the merits and

shortcomings of the machine, and I certainly was surprised to find that the consensus of that opinion was favorable. The writer dislikes to be in the minority, but he has enjoyed many opportunities of passing judgment on so-called original types of locomotives that were going to push the common types out of service. He never made a mistake of judgment in telling that the ordinary original type of locomotive was a fake. He has now no hesitation in saying that the Thuile will fall into rank with the Fontaine, the Raub Central Power, the James Toleman and the Holman locomotives, which are all of amusing memory."

### An Early Double Ender.

The oddity shown in Fig. 261 was one of several locomotives built in 1862 by the Northern Railway, of France. The best that can be said of this locomotive was a remark made on a ridiculous freak designed in the office of Locomotive Engineering, and called the Gilderfluke, as a take off on idiotic designs of locomotives getting forced into notice. This engineer remarked, "the thing would move." As may be noted, this was one of the early double end locomotives.

### La Parisienne.

A remarkable freak that was to be seen in Paris in 1900 bore the above name. It had three pairs of driving wheels, 7 feet diameter, coupled, and two pairs of wheels of the same size carried the tender. Its curious appearance was the only thing that made the Parisienne worthy of passing notice.

### Johnstone's Double-Ended Compound.

A famous engineer once remarked to an inventor, who had presented an extraordinary complicated arrangement of mechanism as an improved valve motion, "You are suffering from abnormal inventive fertility." An engineer gifted with the inventive faculty is in danger of pushing his inventive fertility to a rank crop that is expensive to harvest. I have always thought it was some such inventing force that pushed F. W. Johnstone, mechanical superintendent of the Mexican Central Railway, to design the locomotive shown in Fig. 262, which was one of three built in 1892.

The engine, as will be readily understood, was a most extraordinary form of a locomotive. It looks like two Mogul—2-6-0—locomotives fastened cab to cab; but it is structurally a good deal

more than that. The reputed purpose of this odd type of engine was to provide an extraordinarily powerful flexible motor for climbing the steep mountain grades of the Mexican Central Railroad, the flexibility being sufficient to go round very sharp curves with the least possible frictional resistance. The flexibility was obtained by securing the driving wheels in a truck, which was free to move in a line different from that followed by the main frames. In the Mason bogie engines, the driving wheels were grouped in a flexible truck which carried the cylinders. In the Johnstone engine, the cylinders and boiler were carried on the main frames, separate from the driving wheel truck.

As the cylinders were not in line with the driving wheels in passing curves, it was necessary that a special method of trans-



Fig. 261. A French Experiment of 1862

mitting the power from the cylinders should be employed. This was done in a very ingenious way through levers that transmitted the power and at the same time compensated for the varying distances between pistons and crank, due to the swivelling of the driving wheels. Without the compensating arrangement, it would have been necessary to give the engine so much cylinder clearance that the loss of steam would have been very great. The power transmitting levers are seen in the back of the cylinders, connected at the top by a short link and the bottom ends pinned to the front end of the main rods. There were two of the latter, one connecting with a crank pin, the other with a return crank. The piston transmitted motion to the back one of the two levers, and that gave motion to the front lever, which was fulcrumed securely to the frame near its center.

The engines were compound, with annular cylinders, the high pressure cylinder being in the center and the low pressure cylinder forming the outside concentric ring. The high pressure cylinder was 13 inches diameter, and the low pressure 28 inches. The stroke was 24 inches. It was calculated that each pair of cylinders would develop power equal to a 19 x 24 inches simple engine.

That cylinder arrangement violated the principles relating to the conservation of heat, for the comparatively cold low pressure steam encircling the high pressure cylinder would be certain to exert condensing effects upon the steam in the high pressure cylinder. Even in the hands of their friends, it was difficult to keep the engines at work, and after a few years of unsatisfactory service, they were changed to accepted forms.



Fig. 262. Johnstone's Double-End Compounds

### **An Original Form of Contractor's Locomotive.**

Among the minor sacrifices to good intentions that were called locomotives was that shown in Fig. 263. This was the first product of the Pittsburgh Locomotive Works, and was built by Thatcher Perkins, engineer and superintendent of the company, for the contractor of a narrow gauge coal road near Pittsburgh, named Bausman. The workmen called it "Bausman's Rhinoceros."

The curious thing about the engine was that it had no main or side rods, the piston rods extending out on both ends of the cylinders and connected to slotted cross heads, fitted with sliding blocks, in which the crank pins worked. The valve gear was of the Carmichael type, illustrated in the chapter on Valve Motion.

### The Oldest Curiosity.

During the Diamond Jubilee of the late Queen Victoria, when all London was decorated with flags, streamers and emblems, the headquarters of one of the well known cricket clubs in that city had among their decorations the words, "Well played; 60, not out." The old engine which we illustrate is still at work, and the North Eastern Railway of England might well say of it, as the cricketers did of the Queen, "Well played; 84, not out."

We are indebted to Mr. Wilson Worsdell, chief mechanical engineer of the North Eastern of England, for the photograph, diagrams and information concerning this remarkable engine. Mr. Worsdell is of the opinion that it is the oldest locomotive in the world that is daily under steam, for it was built in 1822 and is now regularly used as part of the motive power equipment in the col-

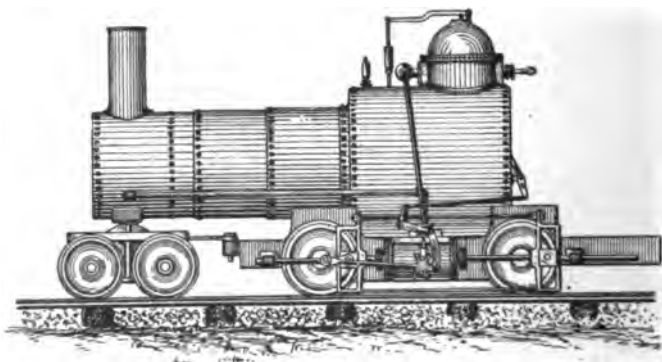

Fig. 263. Pittsburgh Slotted Crosshead Locomotive

lieries of Sir Lindsay Wood, who is one of the directors of the North Eastern Railway. The collieries are situated in the county of Durham, at a place called Hetton-le-Hole, in England.

The engine has vertical cylinders  $10\frac{1}{4}$  inches in diameter and 24 inch stroke, with cross arms instead of cross heads working in upright guides which are braced diagonally from the top of one to the bottom of the other. The cylinders rest directly on the shell of the boiler, which is not covered with any lagging. There is a small cab on one side, in which the "driver" is evidently allowed to sit down. The half-tone illustration shows him with his hand on the brake apparatus. This is a form used a good deal in the British Isles, and is an upright shaft placed in a hollow stand. The

shaft has a screw thread cut on the lower end, upon which a nut works. The nut has two trunnions on either side, which take the place of a pin in a lever. The nut can be run up or down the shaft, according to the way the handle is turned, and the nut, although moving the end of a lever, always remains parallel to itself.

The familiar "life guards" are to be seen in front of the leading wheels. These are the vertical metal bars which reach from the buffer beam to very nearly the rail level. They are used throughout the British Isles and on the continent at the present day. The sand box is seen comfortably nestling against the side of the smoke box on the running board level.

The line engraving, Fig. 266, shows the valve gear at A as it was originally built. The motion which actuated the valve was obtained from a cam working in a square box. This motion was conveyed

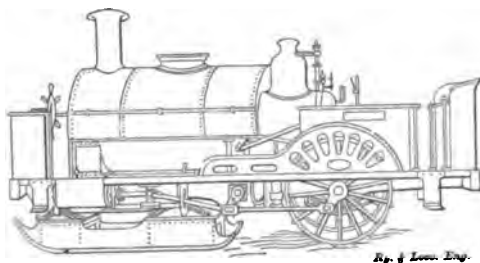

Fig. 264. Grew's Ice Locomotive for Russia, 1861

through connecting links and rods to a lever fixed above the steam chest. The valve worked in a box on the slide spindle. The reverse motion was obtained by the driver withdrawing bolt C and moving the rod to other end of lever and replacing the bolt at point marked E. This had to be done separately for each of the cylinders. About the year 1880 the old arrangement was altered. An eccentric sheave was fixed on the axle instead of the cam, and the motion was conveyed through a link, as shown at B. This arrangement is more clearly shown in Fig. 267. The reversing lever was so fixed so as to shift the link block in the link. The half-tone illustration exhibits this arrangement also, but the adjacent ends of the links and the bottom of the reverse lever and its fulcrum are hidden behind a metal plate.

According to our modern rule, the engine has a calculated tractive effort of about 4,700 pounds. The dimensions of this

hardy survivor of pioneer days, as given by the Hetton Coal Company, Ltd., is as follows:

Diameter of boiler, 4 feet 4 inches; length of boiler, 10 feet 2 inches.

Length of fire tube, 5 feet; diameter of fire tube, 2 feet 1½ inches.

Length of tubes, 5 feet 2 inches; diameter of tubes, 2 inches.

Number of tubes, 58; length of fire grate, 3 feet 2 inches.

Width of fire grate, 2 feet 6 inches; steam pressure, 80 pounds per square inch.



Fig. 265. Oldest Locomotive in the World, Daily Under Steam

Diameter of cylinders, 10¼ inches; height of cylinders above boiler, 1 foot 6 inches.

Length of stroke, 2 feet; depth of piston, 4 inches.

Diameter of wheels, 3 feet; diameter of axles, 5 inches.

Wheel base, 6 feet 4 inches; 4 wheels coupled.

One cylinder to each pair of wheels; length of frames 12 feet.

Thickness of frames, 1 inch; boiler fed by one injector and one feed pump.

Length of tender, 9 feet; width of tender, 3 feet 10 inches.

Diameter of tender wheels, 3 feet.

Capacity of water tank on tender, 137 Imperial gallons.



Vertical clearance in axle box guides,  $1\frac{1}{2}$  inches.

Diameter of smoke box, 3 feet 8 inches; length of smoke box, 1 foot 11 inches.

Coal consumed per day of 11 hours, 10 cwts.

Size of water tank, 3 feet 11 inches long, 3 feet 3 inches wide, and 2 feet 10 inches high.

Coal bunker on tender, 4 feet by 3 feet 3 inches.

Height of center of boiler above rail, 5 feet.

Water in tank will serve three hours.

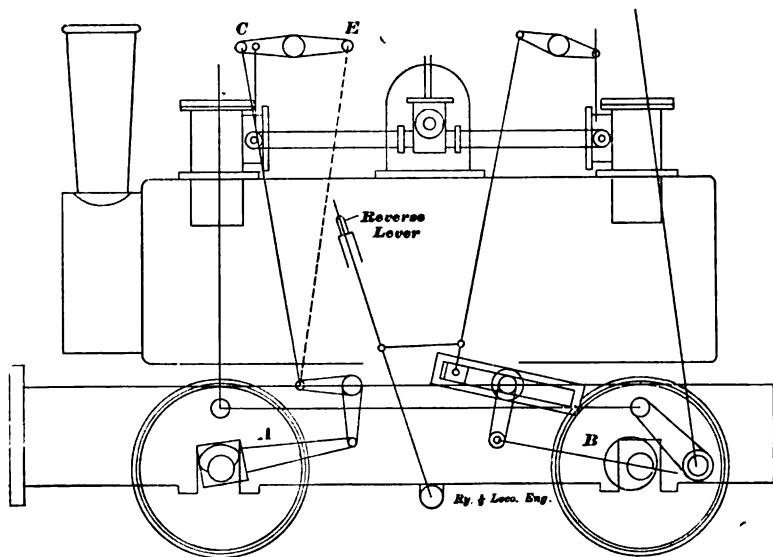

Fig. 266. Original Valve Motion

### Oscillating Cylinder Locomotives.

Oscillating cylinders were in great repute for steam engines for a few years, especially for marine power, and claims were persistently made that an oscillating engine would transmit more power to the crank pin than any other. Those favoring that kind of engine held that it had no dead center to speak of and that the leverage was correspondingly great.

A locomotive might not be regarded as a good subject for the application of oscillating cylinders, yet that has been done successfully and Dewey Bros., Goldsboro, N. C., are making such locomotives for logging railroads, one of them being shown in Fig. 268. As will be observed, the piston rods are

coupled direct to the crank pin. The engine is reversed by means of a four-way cock which changes the steam pipe into an exhaust pipe and vice versa. The cylinders oscillate on a trunnion which passes through the middle casting. This trunnion passes through a coil spring which pulls the cylinder up against the saddle, allowing it to oscillate and yet make a tight joint. No valve gear is necessary.

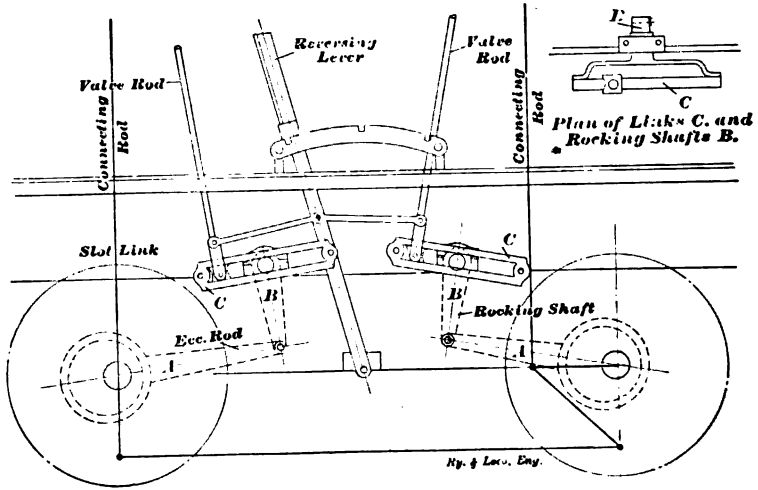

Fig. 267. Modernized Valve Motion



Fig. 268. Engine with Oscillating Cylinder and No Valve Gear

# Growth of the Train Brake

## CHAPTER XXVIII.

The vehicle brake is a comparatively modern invention, which became necessary only when highways were made sufficiently substantial to permit vehicles being moved faster than a horse could walk. The stage wagon was not introduced into England till 1564 and it took many years to advance to the stage coach and other vehicles that achieved the velocity of a slowly trotting horse.

With all kinds of vehicles, the question of braking has always increased in importance as the demands for greater speed were granted. Toward the end of the 18th century public conveyances between leading towns in Great Britain were making an average running speed of about eight miles an hour. This soon stimulated a demand for brakes.

### The Patented Brake Begins to Appear.

During the century from 1770 to 1870, there were granted in England about 190 patents for various kinds of braking appliances for common road vehicles. Of these 46 were applied to the periphery of the wheel, 28 on the nave, 27 were actuated by the movement of the horse, 21 were applied to fly or brake wheels, 8 were applied to the axle, 10 were actuated by a spring, 4 were automatic, 3 electromagnet, 3 pneumatic, 4 relied on momentum, 3 accumulated power for subsequent propulsion, and a variety of oddities. In America 170 patents had been granted for brakes, 21 of which were automatic.

The crude form of railroads that used wooden rails had been increasing in number long before Trevithick or Hedley or Evans had begun scheming to apply steam engines to traction purposes, and the horse-hauled wagons came to be gradually equipped with crude brakes to stop them on descending grades. One of these early brakes consisted of a metal tipped beam which was fastened to the frame of the car in such a way as to scrape along in the ground at the side of the track. Another form was a simple lever pivoted to the side near the center of the car and ordinarily held by a chain, which could be liberated and pressed by hand or foot upon the top of the wheels.

### **The Locomotive Stimulates Brake Inventing.**

The advent of the steam locomotive stimulated inventors to produce brakes as powerful relatively as the steam engine is over the horse. During the first 70 years of the 19th century about 650 patents were granted in Britain for various kinds of brakes for railway service. Of these 21 were electro-magnetic brakes, 20 hydrostatic, 32 pneumatic, 50 steam and the balance of various kinds, mostly hand brakes, and different designs of foundation brake gear. In 1833 Robert Stephenson patented his steam brake, consisting simply of a small cylinder containing a piston, the rod of which connected through a system of levers to a cam brake. The first pneumatic brake was a vacuum brake, patented in 1844 by James Nasmyth, the noted inventor of the steam hammer, and one Charles May. Samuel C. Lister in 1848 patented an air brake having an axle driven pump and suitable reservoir. This was a straight air brake and was to be placed in the guard's van and operated by the guard. It never emerged beyond a paper invention.

The United States was by no means behind Europe in the invention of train brakes. Up to 1870 there had been granted 305 patents for railway brakes, of which 8 were automatic, 3 electro-magnetic, 5 steam, 1 vacuum, and 2 air brakes, the balance referring to various forms of foundation brake gear and other devices, which have never stood the test of actual use.

I have condensed the foregoing statement from the Westinghouse book on Air Brake Tests.

By the year 1850, the locomotive engine had become almost as efficient for train hauling as it is to-day, and its economical performance has been little improved by the lapse of time, which proves that the pioneer locomotive designers labored diligently to perfect their engine. By the year 1850 there had been train brakes patented in sufficient numbers to provide liberal selection of an efficient brake, but for twenty years later the railroad managers of the world contented themselves with the crude brakes that came into use early in the thirties.

### **Helpless Condition of Fast Trains in Early Railroad Days.**

Although a velocity equal to the highest speed common with railroad trains of to-day was attained during the first ten years of railroad practice, almost forty years elapsed after the railroad locomotive was a pronounced success, before any reliable system was

established of bringing trains quickly to a state of rest. Up to the year of 1870, ordinary fast trains resembled in a striking manner the Congreve ricochet-rocket, made famous in the early railway days to illustrate the helpless condition of a fast running train. The means were there to originate the speed, but when a sudden demand arose for stoppage, in too many cases, the only retarding forces available were the natural resistances to the moving mass. In regard to the speed of trains, railroad engineers resembled Ulysses when he released the winds and raised a tempest that he could not subdue.

### **Want of Control Led to Many Serious Accidents.**

This condition of helplessness led to many a grievous disaster, before the traveling public were educated to demand, with the voice of authority, appliances for stopping trains promptly whenever necessary or desirable. And then it was no easy matter to impress railroad managers with the belief that a good system of brakes could be devised which would do the work of absorbing the speed far more quickly than it could be developed by the steam.

### **Early Valve Motion Prevented the Locomotive from Helping to Stop Trains.**

During the first decade of railroad life, engineers were so much occupied with plans and improvements for increasing the efficiency of the locomotive as an agent of speed and traction, that almost no attention was bestowed upon the means of restraining or controlling the velocity attained. This was all the more surprising, as the locomotive of these times equipped with the drop hook, was a peculiarly helpless machine when called upon to aid in stopping the train it had set in motion. With the link motion of later years, the steam could be depended upon by reversed motion to aid in stopping; but the drop hook nearly always failed to catch when an attempt was made to reverse the motion when the engine was running at any speed, and the V hook was not much better. Yet, with this helpless condition of the locomotive, the rude brake that controlled the country wagon was deemed sufficient for holding passenger trains.

### **First Form of Train Brake.**

A horizontal lever with a bell crank at the end to which was connected a wooden block, was the form of brake used on pioneer trains. When a call for brakes was made, the brakeman dropped

the lever out of its notch and stood upon it to increase the pressure upon the wheels. Some early roads were not even so well provided as this with the means of stopping. It is recorded that on a South Carolina railroad for some time after trains began to run regularly, the only means of stopping a train at a station was by all the trainmen and others clinging to the cars, holding them back, or by pushing pieces of cord-wood between the spokes of the wheels.

From the day it first appeared, the locomotive was accorded zealous attention, the select talent available being devoted to its improvement and careful maintenance. With the train brake it was different. It was not a revenue earner, but a source of expense without profit. The train brake held the same relation to a locomotive that the non-combatant does toward the active fighters in armies and navies. It took many years, darkened by disaster, to change that sentiment.

#### Improvements Begun.

On most roads the hand-lever brake was early displaced by the hand-wheel and chain for passenger equipment, an improvement which rapidly became the recognized method of stopping trains. When the four-wheeled truck first came into use, the brake attachment consisted of four vertical wooden blocks, two of which were hung between each pair of wheels, and were applied by a canting bar fastened between the blocks and operated by a lever connected with the chain. The wooden blocks were lined with leather, which endured the rubbing wear of the wheels better than the wood, besides being easily renewed when worn. This crude rig was superseded before 1840 by the common freight car brake, which experienced remarkably few improvements until safety appliance laws were enacted. Wooden blocks were exchanged for iron shoes, and the working parts were made a little stronger. Where power has been applied to the brake, some complication of levers has been introduced to equalize the pressure, but up to 1890 the brake was essentially the same as it was in 1840.

#### The Common Hand Brake.

The common car brake had points about it which gave strong recommendations in the eyes of railroad men. It was simple and tolerably efficient for slow speed, and it rarely got out of order, while every part about it was easily reached, and any man could understand it. By degrees it worked into universal favor, not

only with railroad men, but also with the traveling public. By the time trains became heavier and the common speed too high for safe control by any hand brake, this brake had become time honored, and it is a difficult matter superseding a time-honored institution, however long it may have outlived its usefulness.

### **Importance Attached to Brakes in America.**

In operating American railroads, the brake has always been the most important factor in securing the safety of trains. Railroads are mostly single tracks, steep gradients are numerous, there used to be no signals to protect stations, or level railroad crossings; at the same time stations and crossings are located with utter disregard of safe natural approaches, round a curve on a steep descending grade, in a cutting with trees and bush all round, being a common position to find a station or the crossing of another railroad. If the engineers who located thousands of miles of American railroads had previously enjoyed some experience running locomotives, or as brakemen, hundreds of traps for accidents that have killed and maimed many people never would have been set.

### **Immunity from Accidents of the First Railroad Decade.**

The first ten years of railroad life were remarkably free from serious accidents resulting in loss of life. This permitted the crude methods of operating to be accepted as satisfactory. Had any of the terribly fatal accidents which happened later, through defective brakes and want of signals taken place in the first five years of train service, the probability is that operating appliances would have been improved, so that much subsequent destruction of life and property would have been avoided. What were really reckless practices, were regarded as ordinary concomitants of the new method of transportation. Recurring fatal accidents were needed to convince the public that the hand-brake was not perfect. The grim missionaries, Disaster and Death, went the rounds of railroad men with appalling frequency before the first American locomotive was thirty years old, and inventors were called upon to provide better means of controlling trains.

### **Bumper Brakes.**

Ever since the need of a brake superior to the hand-brake became recognized, those possessing the highest mechanical talent of the country have labored to produce a brake whereby the whole



train would be automatically subjected to retarding action. As already mentioned, what was intended as a continuous train air brake was patented in England in 1848, but it never was put into practical use, there having been no demand for continuous brakes in Europe until they were introduced from America.

The United States' inventors took the lead in devising continuous brakes. The first attempts in this line were made to devise means of operating the brakes from the crowding together of the cars. This class of brakes were known as bumper brakes, and the crop of patents for devices of this kind has been remarkably fertile. It began to grow about 1845, and the harvest was hardly over when the 20th century began. No bumper brake came into practical use in the days when an improvement on the single hand-brake was urgently needed.

### Connecting the Brakes on Both Trucks.

The first real improvement effected on the hand-brake was the connecting of the brake on both trucks, so that the hand-wheel at one end of the car applied the brake on both trucks. By means of this invention a brakeman could apply brakes to four trucks without having to move, except go from one platform to another. It almost doubled the work that one brakeman could do. The credit of this invention is no doubt due to Willard J. Nicholls, car shop foreman of the Hartford & New Haven Railroad. He did not patent his invention and others appropriated its valuable features, passing it through the patent offices as their own. The invention drew many thousands of dollars from railroad companies, but none of the money went into the pockets of the real inventor. The Tanner brake, of litigious memory, appropriated the Nichols invention entire. The Hodge and Stevens brakes each were arranged to apply the brakes on both trucks from one end of the car, but neither of the inventors claimed that as the object of their patent. Their patents were obtained for certain arrangements of the rods and levers used in transmitting the power applied. Hodge received the patent for his brake in 1849, and his leading idea seemed to be the simplifying of the connections. When the Stevens brake was patented in 1851, the inventor claimed that by the arrangement of rods and levers, each wheel in both car trucks received a uniformly retarding force. This was the first claim for equaling the pressure on the brake shoes. Both these brakes proved highly successful. Within a few years one or the other of them

became part of nearly all passenger train equipment, and was applied to the double trucked cabooses belonging to the freight trains. And to-day the brakes hold a monopoly in these positions, the application of continuous power having interfered in no way with the original arrangements of these brakes.

### **Foundation Brake Gear—Stevens System and Hodge System.**

By F. M. NELLIS.

Prior to the introduction of air brakes on railroad cars little attention was given to correctness of design of the foundation brake gear. Ofttimes there were brake levers on one truck of the car only. In other cases there were brakes on both trucks and connected up to one hand brake only.

With the advent of the air brake, however, more attention was necessarily given to the design of foundation brake gear. The brake cylinder gave out a definite and uniform amount of power, which was different from the variable brake power of the individual brakeman pulling at the hand brake, and the determining of the leverage with a view of getting all available braking power possible without sliding the wheels, was for the first time recognized as an essential in train stopping.

The foundation brake gear usually found under a passenger car prior to the advent of the air brake consisted of a lever extending across the car, pivoted in the middle, and a brake rod running to each truck, providing both trucks were braked. When it was decided to equip the cars with air brakes the long lever was removed and the rods to the hand brake and the brake beam levers on the trucks were cut in two. The brake cylinder was then interposed at the most convenient point and the rods reaching to the brake beam levers on the trucks were connected to the cylinder levers at the brake cylinder.

The first and simplest form of air brake foundation gear designed was known as the Stevens system. This system consisted of the usual brake beam levers on the trucks of the cars, the top pull rods of which were connected with the cylinder levers at the cylinder. A connecting rod, or chain and rod, coupled the dead brake beam lever on each truck with the hand brake staff and wheel at the car platform, thus supplying a hand brake operating on a dead lever and in opposition to, or pulling against, the air brake.

A fairly good single-hand brake was made by connecting the hand brake to the piston in the air brake cylinder, thus

pulling out the brake piston similar to its normal operation with compressed air, and, through the medium of the levers and rods, pulled the brake shoes up against the wheels. This design, however, was abandoned on account of its inability to afford a double hand brake.

The system known as the Hodge system, which later came into use, consisted of the usual brake beam levers and the cylinder levers, and had a floating lever, which is sometimes known as the Hodge lever, interposed between the brake cylinder and truck. With this system the piston pressure was exerted on the cylinder levers, the outer ends of which pulled on a connecting rod, which, instead of being attached to the upper end of live lever as with the Stevens system, connected into the middle of the Hodge equalizing, or floating lever, near the forward portion of the truck. One end of the floating lever was connected to the top end of the live brake beam lever, while the opposite end of the floating, or Hodge equalizing lever, was connected to the hand brake, on the platform of the car. This arrangement gave a double hand brake, one on each end of the car, but operated contrary to, and against the pull of the air brake.

This latter type of foundation brake gear, commonly known as the Hodge system, is the standard system to-day for many passenger cars' equipment. The system usually employed upon modern locomotive tenders is very much like the original Stevens gear.

The Hodge system not only furnishes better opportunities for a hand brake, but shorter levers may be used on the cylinders which require less room in which to operate and which is required for other apparatus than the air brake under the modern passenger car.

The Hodge system, modified, is now used on some roads where an independent equalizing lever runs crosswise of the car, is coupled to the hand brake on both platforms of the car, and will permit the cylinder lever to be pulled out by the hand brake from either end of the car in the same manner that it is shoved out by the brake piston in the cylinder. A slotted cross-head is used which permits the brake piston to remain at rest while the foundation brake gear is being pulled up by the hand brake. In air brake application the parts operating are the same as with the standard type of crosshead.

The increase of train accidents, and the growth of public sentiment in favor of improved means of controlling trains, can be traced very clearly in the records of the Patent Office. Singularly enough, until recently, the American public have never looked with any favor upon signals as a means of averting accidents. They call for means of seeing the track at all times, and for facilities for stopping in time to avert accidents after obstruction is perceived.

### **Obstacles to a Continuous Train Brake.**

It was surprising how slowly a continuous train brake was evolved, considering the numerous inventors who devoted their attention to brakes before the air brake achieved impregnable success, as late as 1870. The probability is, that several of the inventions devised between 1845 and 1860 might have been developed into fair continuous brakes, but railroad companies gave inventors no encouragement. Most of the railroad managers were of narrow training, and considered the hand-brake as near perfection as was necessary. They had no patience with inventors who disturbed public tranquility with impressions that a safer and more effective brake could be produced.

### **Difficult Functions of a Continuous Train Brake.**

Where an apparatus has to perform the complicated functions required of a continuous brake, the parts have to be finely adjusted and well proportioned for the work they must perform with absolute certainty. To adjust a brake so that it could be operated effectively from one point, and yet be strong enough in every particular to stand the rough jostling of a train in rapid motion over an uneven track, where no two trucks stand in the same horizontal plane, was an extraordinarily difficult mechanical feat. All the details could hardly be evolved complete from the brain of the most accomplished inventor. Experience and observation in actual service were needed, so that weak points might be strengthened and mistakes rectified. Numerous valuable inventions that were crude on first conception, have been perfected by the suggestions and directions of experience.

The first continuous brake needed to go through this tentative ordeal; but it was practically impossible to induce railroad managers to give it the opportunity for a thorough trial. An inventor might offer for use what had the elements of an excellent brake, yet, if a minor part failed on a trial reluctantly granted, the in-

ventor was treated with contumely and the brake sneered into oblivion. That has been the fate of many inventors and inventions.

### **Urgent Need of a Continuous Brake.**

Railroad traffic had developed into such great proportions on many American railroads by the year 1860, that common prudence demanded the devising of systematic means to guard against violent accidents in the ordinary movement of trains. As the roads were still devoid of any proper signal system, it was becoming daily more urgent that powerful continuous brakes should be adopted, which would always be sufficient to keep trains under control, or that a well arranged method of station signals to protect trains, should be introduced without delay. The necessity for better safeguards was eloquently advocated by the most far-seeing leaders of public opinion, but their recommendations were for years ignored by those who alone could carry out the desired reforms. And at this time other momentous events distracted the public mind, so that little attention was bestowed upon railroad matters.

### **Increase of Train Accidents.**

The Civil War relieved railroad companies for a few years from the salutary influence of freely expressed public opinion, but events recurred at brief intervals which prevented the people from forgetting that railroad travel was environed with menacing dangers for which there was no righteous excuse. Fatal accidents to travelers were becoming alarmingly frequent, and minor casualties were often overshadowed by appalling disasters, which, in many instances, were entirely preventable. When the killing and maiming of men is confined mostly to railroad employees, the general public has endured a great deal of bloodshed with calm fortitude, as used to be seen in the prevailing apathy regarding the slaughter that resulted from coupling cars; but when the killing becomes promiscuous, public indignation is apt to wax warm.

### **Preventable Train Accidents.**

As long as vehicles continue to be run at high velocity, fatal accidents will be common from unavoidable causes such as the breakage of material or human fallibility. Such accidents will be condoned; but others that result from absence of well-known safety appliances will always excite wrath and demands for punishment. The reluctance of railroad managers to adopt good brakes

caused disasters too numerous to record, just as the reluctance of railroad companies to introduce proper train block systems is to-day making a sanguinary record.

A few of the accidents due to defective train control may be profitably mentioned. As far back as 1853 an express passenger train was approaching a drawbridge near Norwalk, Conn., at the rate of fifteen miles an hour. When over 400 feet from the bridge the engineer realized that the draw was open, but with the defective brakes in use, the train could not be stopped and it dropped into the chasm. The water was about 12 feet deep and most of the train piled in a confused heap about the engine. When the wreck was cleared up, it was found that 46 persons had lost their lives, besides severe injuries-being inflicted upon many others.

A characteristic defect of the hand brake was its being liable to fail when most urgently needed. In ordinary stops the brake would do its work satisfactorily when properly manned. But in case of an impending accident, the application of the brakes had to be whistled for, and the time that should have sufficed to make a stop was often wasted before a brake wheel was turned. Valuable seconds that count as throbs of life, precious moments that gauge the line between life and death, were frequently thrown away by brakemen trying to see what was the matter before they applied the brakes. Again, when derailment took place, from any cause, brakemen would not or could not get out on the platforms to apply the brakes, the consequence being that partly derailed trains rushed along without control, smashing cars to atoms with terrible consequences to the occupants.

An impressive example of this kind of accident happened near Port Jervis in 1858. As an express train from New York was rushing along on a perfectly straight tangent, a broken rail threw the last car off the track. The swaying and plunging of this car over the ties, pulled the next car off the track, also, and after plunging along for about 400 feet, the two cars broke away from the rest of the train and rolled down an embankment. The other part of the train ran half a mile before it was stopped. Six persons were killed and fifty severely injured.

But the most horrible accident of this character happened at Angola, N. Y., on the Lake Shore and Michigan Southern Railway in December, 1867. As an eastbound express train passed Angola at a speed of thirty miles an hour, the last car of the train jumped the track on one of the station frogs. About 1,200 feet further on was a high bridge. The derailed car pounded over the

ties till this bridge was reached, when it broke away and plunged down into a ravine fifty feet below. Only three persons escaped from that car alive. It instantly took fire from the stove then used and burned up over forty persons who were confined in a struggling mass in one end of the car. The front of that train ran half a mile before it was stopped. A terrible storm of indignation followed that accident and the railway company's management were accused of wantonly slaughtering people wholesale, through being too penurious to adopt proper brakes.

The most reliable continuous brake then in use was the Creamer, a very defective appliance at the best, but every accident which was aggravated by the absence of efficient brakes aroused demands for the Creamer. That brake, which was brought into use about 1853, consisted of a large spiral spring attached to the brake staff at the end of the car, which was wound up by the brakeman after leaving a station. Attached to the mechanism was a cord, which ran through the train to the engineer's cab, and the brake was so designed that when the engineer pulled the cord, coil springs on each vehicle were released and these at once wound up the chains leading to the foundation brake gear, thereby bringing the brake shoes against the wheels. The Creamer was an emergency brake, pure and simple, and, like all emergency devices, was very frequently out of order when wanted.

The Creamer brake, although superior to the hand brakes in an emergency, was very defective when sudden stops had to be made. At New Hamburg, on the Hudson River Railroad, in 1871, a freight train was stopped in the evening on a bridge with a car off the track. A passenger train came along and was within 600 feet of the stalled train before the danger signal was seen. The Creamer brake was promptly sprung and the engine reversed, but a collision happened. Part of the freight train was loaded with oil, turning the worst kind of train accident—a collision on a bridge—into a holocaust. Twenty-one persons lost their lives.

### Loughridge Chain Brake.

Another of the early attempts at improved brakes was the Loughridge Chain Brake, which first appeared in 1855, and consisted of a system of rods and chains continuously connected throughout the train as follows: On each vehicle were two pairs of small pulleys, each pair sliding towards the other upon an iron framework but held apart by a spring. To each pair was connected a top rod

leading to the foundation brake gear. Upon the engine was placed a drum connected by a worm and gear to a small friction wheel. When a lever in the cab was pulled this friction wheel was brought into contact with the peripheries of one of the driving wheels, thereby causing the drum to wind up the chain and shorten its length throughout the train. In doing so the pulleys upon each vehicle were brought closer together, thereby applying the brakes.

A chain brake like many other specious devices has been found more efficient in theory than in practice. A train of cars is of varying length. When all the bumpers are compressed, it is shorter than when the engine is pulling with all the drawbars distended. This stretching of the train proved fatal to the success of all chain brakes and there were many of them tried. Although several ingenious devices were tried with the Loughridge brake to compensate for the stretching of the train, that source of weakness made the brake unreliable. When the chain was not strong enough to stand the pull necessary to haul the whole train, it was always liable to get broken. Any engineer will easily perceive other objections to a chain brake, where every link is a source of weakness. The only thing to be said favorable to the Loughridge brake was that it demonstrated the unreliability of chain and paved the way for a reliable continuous brake.

Chain brakes were tried to a considerable extent on European railways, especially in Great Britain. F. W. Webb, of the London and Northwestern Railway, favored and fostered one or two, but he and his whole staff could not make them reliable.

In France Chatelier, an eminent railway engineer, introduced a means of train control through the cylinders of the locomotive. His invention consisted in making provision to prevent the cylinders and valve seats from being injured by the suction of hot gases and cinders when the engine was running reversed. Chatelier's brake has been applied on many locomotives operating mountain railroads under the name of the water brake.

### **An Unlucky Steam Brake of 1850.**

Power brakes did not receive fair treatment until dense traffic and high speed of trains forced them into use. Among very promising power brakes tried long ago was one on the Glasgow & Southwestern about 1850. The brake was applied to the driving wheels only and worked quite satisfactorily, a real difficulty with it being that the enginemen displayed no



judgment in its application. They would run close to a stopping point and then apply the brake with full force, with the result that the flexible springs employed on the buffers of British carriages recoiled quickly and jerked the passengers so badly that there were constant complaints made. That, of course, resulted from lax discipline.

The brake was making friends, however, as its advantages were becoming slowly recognized in a land where innovations are not generally regarded with loving kindness. But an accident brought the career of usefulness of the brake to a sudden end, amidst undeserved contumely and passionate abuse. The accident happened in connection with the Ayr races—

“Auld Ayr wham ne'er a town surpasses,  
For honest men and bonnie lasses.”

Will Marshall was running an engine equipped with the steam brake, and, on the day of the races, he was pulling a fast express train. A train filled with excursionists and race horses was standing on the main line at Ayr and Will ran well up to the station, depending upon the steam brake. On its being suddenly applied one of the levers broke and the express train dashed with almost unchecked speed into the rear of the excursion train, making a dreadful carnage of human beings and horses. The steam brake got all the blame of the catastrophe, and all that had been applied were consigned to the scrap heap without a day's delay. The poor inventor, instead of receiving any reward for what was really a well designed brake, was ridiculed and abused as a crank who was trying to obtain the opportunity of slaughtering people wholesale.

#### Blamed Steam Brake for Boiler Explosion.

Writing on the subject of steam brakes, Mr. George Richards, formerly superintendent of motive power of the Boston & Providence, said: “Mr. G. S. Griggs commenced building locomotives at the B. & P. shops in 1845. He built in all 26 engines—all eight-wheelers with crank axles.

“His steam brake was arranged as follows: An upright cylinder was placed over the boiler, a piston rod ran out at the top, a cross bar was attached to this rod, and on each side was a lever with a middle fulcrum; one end of each lever was attached by a link to the cross bar, the other end of each forced down a rod, to which was attached a brake shoe which bore partly between the drivers.

This brake was on two locomotives and worked well. It was discarded because it was ahead of the times.

"One of these locomotives exploded its boiler in the winter of '48-'49. After the scientific people had given the subject a prayerful consideration, they decided that the explosion was caused by the steam driver brake. A few of us, on the inside, however, knew that the safety valves were screwed down solid. There were no steam gauges in use at that time.

"Mr. Griggs also had a train brake in use at that time, and applied the power to the wheels of the tender and all of the cars, and it was in use for a long time.

"I cannot tell when the brake was first used, probably early in 1848.

"In 1849 the time of the fastest train was one hour and fifteen minutes between Boston and Providence. Now it is one hour, showing a gain of fifteen minutes in forty-five years."

## The Westinghouse Air Brake

A new era of train control dawned when George Westinghouse, Jr., invented his atmospheric brake.

In this exacting age the traveling public are much more disposed to find fault with systems that do not provide against fatalities resulting from human fallibility, than to commend the perfection of appliances which annually save more lives than would be lost in a sanguinary war. The Westinghouse brake has performed this life-saving service, yet its great conserving merit has been but feebly appreciated outside of railroad circles. During the decade between 1860 and 1870 America became a reproach among nations for the frequency and disastrous nature of its railroad accidents. For years after the general introduction of the air brake upon passenger trains, fewer railroad travelers in America lost their lives by accidents beyond their own control than the travelers in any country under the sun. The credit of this immunity from fatal accidents was almost entirely due to the successful operation of the Westinghouse air brake.

American railroads have of late been earning an evil reputation for fatal railroad accidents, but they have resulted mostly from trying to operate fast trains on congested lines, loose discipline and the absence of positive block signals. The Westinghouse air brake has never failed to meet the most sanguine expectations,



**GEORGE WESTINGHOUSE**

Inventor of the Greatest Life-Saving Apparatus Ever Given to the World

and many railroads are to-day moving safely a volume of traffic twice what could have been moved without this means of stopping trains on short distance.

### George Westinghouse.

Inventions may be divided into two distinct classes. Far the most numerous class are those which effect improvements on recognized appliances. The other is the rare and most valuable class to which belongs the original inventor who devises an entirely new method of apparatus for performing a desired operation. Among this class of inventors may be classed Newcomen's application of the piston which produced the elemental part of a practical steam engine; the multi-tubular boiler of Nathan Read which made a high speed locomotive possible; the electric telegraph by Morse which tied all the nations of the earth together; and the automatic air brake of George Westinghouse, which made the running of high speed trains safe by putting the train speed under the control of the engineer.

Although the name of Mr. Westinghouse is seldom the theme of conversation or of newspaper comment, he is the most original inventor this age has produced, and probably no other individual has rivalled him in the wide range and number of inventions that were considered worthy of the protection afforded by patent bureaus.

George Westinghouse enjoyed the privilege of using machine tools from the day they were part of his toys, for his father was owner of a machine shop and there the sons became expert workmen before they realized that they were learning a business. When he was only fifteen years old George Westinghouse invented a practical rotary engine, and for many years he took a very keen interest in that form of engine. When only seventeen years old he joined the Union Army and served about a year, when he was transferred to the U. S. Navy where he served as assistant engineer till the close of the war.

Shortly after his return from the war, Mr. Westinghouse directed his attention to inventing railroad appliances. His first work in this line was a switch frog, which obtained the reputation of never wearing out. In 1869 he brought out the Atmospheric air brake, popularly known as "Straight Air." This was the most efficient and reliable continuous brake applied to trains when it was introduced. Railroad managers were slow to recognize the advantages conferred by this brake

and it made its way slowly into use. Yet its control of a train gave arguments of a most persuasive character. Before this brake was applied a passenger train, to be safely controlled, had a brakeman on every car ready to respond on the call for brakes. The air brake dispensed with the services of all the brakemen and did the work of stopping the trains more efficiently than the full crew of brakemen.

Every step of improvement on the air brake from straight air to automatic, then from that to the high speed apparatus, all testify to the immense mental resources of this giant inventor. What to others was an insurmountable obstacle seemed to Mr. Westinghouse merely the call for the exercise of a little extra thought labor.

In himself Mr. Westinghouse embraces three characteristics the possession of any one of which generally marks a man above the ordinary level. These characteristics are inventive genius, unremitting industry and profound business capacity. The first attribute has earned him the first place among inventors, the second has brought forth appliances in many lines of industry and the third attribute has enabled him to enjoy the fruits of his genius and industry, not only for himself, but for an army of people whose fortunes have been enhanced by his business success.

An important element in the success of Mr. Westinghouse has been his excellent judgment in selecting assistants. The best engineering and business talent has been found always the leader in the various works that have grown up for the manufacture of the numerous inventions that received their commercial value from his inventive genius. Labor troubles have been unknown in the Westinghouse factories, because the head has always insisted on the policy of giving every man a square deal.

Mr. Westinghouse has been as successful in the development of electric apparatus as he was with the air brake. The importance of the work accomplished by Mr. Westinghouse for humanity has been recognized by various foreign potentates. He received the Order of Leopold from Belgium in 1884. The Royal Order of the Crown from the King of Italy in 1889. He was also made a Commander of the Legion of Honor of France.

With all the glory and honor that phenomenal success has brought to Mr. Westinghouse he remains the same genial

## DEVELOPMENT OF THE LOCOMOTIVE ENGINE.

modest man that friends have loved and acquaintances honored.

### The First Air Brake.

The "Straight Air" brake, which is still used occasionally, consisted of an air pump and a reservoir in which compressed air could be stored. A pipe from the reservoir was carried throughout the length of the train, connection between vehicles being made by means of hose and couplings. Each vehicle was provided with a simple cast-iron cylinder, the piston rod of which was connected to the brake rigging in such a way that when the air was admitted into the cylinder the piston was forced out and the brake thereby applied. In the cab of the engine a three-way cock was located by which the engineer could admit air to the train pipe and thence to the cylinder under each car, or the air already used in the train pipe and cylinders could be discharged into the atmosphere.

The first public trial of the Westinghouse Atmospheric Brake, its official name, was made on the Panhandle division of the Pennsylvania Railroad in April, 1869. The trial was so satisfactory that the Pennsylvania Railroad Company, which have always been noted for their liberal patronage of every meritorious device likely to promote the efficiency and safety of railroad operating, had a train at once equipped with the brake. This was the Walls accommodation train, a kind of service where frequent stops were required and was therefore well calculated to demonstrate the true character of a brake.

### Demonstrations of Efficiency.

A number of public trials were made with the train fitted with this brake, among them one before the Railway Master Mechanics Association in 1869, on the Horseshoe Curve on the Pennsylvania Railroad. Here the train of six cars, running down a grade of 96 feet to the mile at the rate of 30 miles an hour, was stopped in a distance of 420 feet. Such a feat was unprecedented and attracted widespread attention.

On the following month official trials of the train were made by the Pennsylvania Railroad near Philadelphia. The train was then taken to Chicago where numerous tests were made in the presence of leading Western railroad officials. So convincing were these trials of the decided efficiency of the brake that, immediately afterwards, the Michigan Central Railroad

and the Chicago and Northwestern Railway each ordered a train to be equipped with the brake.

Western railroad managers nearly all favored the Westinghouse brake from the beginning, but in New England, where trains had become too numerous to be operated safely by hand brakes, the railroad officials displayed decided hostility to the Westinghouse brake. Some of the same officials received a rude awakening to the danger of clinging to antiquated train brakes.

### **Lesson of the Revere Collision.**

In 1871, more than two years after the Westinghouse atmospheric brake had been introduced, all the railroads in the State of Massachusetts continued to satisfy themselves with the hand brake, although express trains of considerable speed were working their way daily through congested traffic, many of them on lines of single track. On a foggy evening in August, 1871, one of these express trains ran into the rear end of a local train stopped at Revere, a suburb of Boston, killing 29 persons and injuring 57 more. In the history of railroad accidents there probably never was known to be so much indignation excited as there was in Boston on account of the Revere collision. Public meetings were held and the managers of the Eastern Railroad denounced as murderers. The blood of the martyrs was said to have been the seed of the church. The bloodshed at Revere has so keyed up public sentiments to prevent the railroad managers of Massachusetts from forgetting their duty toward patrons carried on their trains.

The straight air brake was making its way rapidly into favor among railroad companies when Mr. Westinghouse determined to provide something that would be more reliable under all conditions of train operating.

### **The Automatic Air Brake.**

The improved brake was introduced in 1872 and was known as the plain "Automatic Brake." The essential difference between the automatic and straight air brakes consisted in appliances that would stop the train if it parted or if anything happened to fracture connections between the engine and the cars.

This was done by the installation of supplementary or auxiliary reservoirs for the storage of compressed air on the

cars in addition to the main reservoir on the locomotive, so that each vehicle carried its own supply, and the employment of a most ingenious valve mechanism, by means of which the application of the brake was caused by the reduction of air pressure in the train pipe, whether such reduction was made intentionally or as the result of accident. The device by means of which this arrangement was made possible was called a "triple valve," because of its three-fold function of applying the brake, releasing it and recharging the auxiliary reservoir. In this triple valve was a slide valve attached to a piston, so placed that train-pipe pressure was always on one side of it and auxiliary reservoir pressure on the other. When train-pipe pressure exceeded auxiliary reservoir pressure, the piston and slide valve took such position that air could flow from the train pipe into the auxiliary reservoir, at the same time opening a port leading from the brake cylinder to the atmosphere; if the train-pipe pressure was reduced below that of the auxiliary reservoir, the piston and slide valve moved to another position in which air could flow from the auxiliary reservoir into the brake cylinder and apply the brakes. The operation of the brakes throughout the train was thus under the entire control of the engineer through the medium of train-pipe pressure actuating the triple valve on each vehicle. A reduction of train-pipe pressure applied the brakes, while the restoration of normal pressure by allowing air to flow from the main reservoir into the train pipe released them.

With the introduction of the automatic air brake, the three-way cock, used by the engineer, was dispensed with and a more elaborate valve, known as the engineers' valve, substituted. This was done because the new valve enabled the engineer to operate the brake with a greater degree of accuracy than what was possible with the three-way cock.

### Vacuum Brakes.

The Westinghouse Air Brake had not long been in successful operation when the Smith Vacuum Brake appeared. Of course vacuum is the reverse of pressure. The Smith Vacuum Brake consisted of two collapsible cylinders that acted like concertinas on each car, connected with two lines of train pipe extending throughout the train and connected between the cars by hose as in the air brake. An "ejector" was installed on the locomotive by means of which the air in the train pipe and



brake cylinders was sucked out and the brakes applied through the contraction of the cylinders with which the brake levers were connected.

The vacuum brake was used to a considerable extent on short suburban lines and on elevated railroads, but it has now nearly disappeared.

Various forms of vacuum brakes have come into quite extensive use in several European countries, in South America, Australia, India and other parts of the globe where cheapness is more important than reliability.

In Britain an automatic form of vacuum brake, by which the brakes were automatically applied to all sections of the train, when accidentally parted, received considerable favor, and is still employed upon some English roads. The general movement toward the adoption of compressed air, as the most satisfactory medium of operation of power brakes, has, however, been accompanied by a gradual decline in the use of the vacuum brake, so that, in this country, at least, it has almost entirely disappeared from general service.

British railway engineers and managers did not take kindly to the Westinghouse air brake at first, principally because it was an American invention and many of them needed a great deal of convincing before they agreed to apply it to their trains.

### Galton-Westinghouse Tests.

In 1877 a paper relating to the Westinghouse Air Brake was read before the Institute of Mechanical Engineers of London. During the discussion of that paper Mr. Westinghouse called attention to the fact that, in testing the action of various kinds of brake shoes, he had observed a very marked difference in the friction of the shoes upon the wheels at high speed and at low speed. He believed that a determination of the facts was of great importance and volunteered to design and construct the necessary automatic recording apparatus and to carry out a system of experiments under the direction of any person who should be appointed by the President of the Institution to supervise the tests and report to the Institution. The offer was accepted and Captain Douglas Galton was chosen to supervise the experiments. The London, Brighton and South Coast Railway placed a locomotive and brake van at the dis-

posal of Mr. Westinghouse and Captain Galton and offered every facility for conducting the experiments.

The results obtained in these experiments, which were the first to be carried out upon any extensive scale, brought out a great mass of valuable information concerning friction and effects of speed on frictional resistances. But the most valuable practical result of the tests was demonstrating the requirements of a perfect brake.

A train rising into speed through the work done by the locomotive slowly accumulates energy. For each ton of weight in the train the accumulated energy is equal to 120 foot tons at 60 miles per hour, 53 foot tons at 40 miles an hour and 13 foot tons at 20 miles an hour. Thus for a train of seven cars weighing 350 tons the energy at 60 miles an hour is equal to 42,000 tons falling one foot.

In ordinary train operating, unlimited time and long distance might be used in dissipating this enormous mass of dynamic energy, in other words, to stop the fast moving, heavy train; but to prevent accident it is necessary to provide a brake that will stop the train in the least possible distance consistent with safety to the rolling stock. The brake tests, as carried out, were calculated to ascertain the actual pressure which it is necessary to exert on the wheels of a train in order to produce maximum retardation at different velocities. This was done with great thoroughness and accuracy.

It was demonstrated that the greatest amount of retarding force can be obtained only by applying brake shoes to every wheel in the train, each shoe being pressed with sufficient force to produce a resistance to the rotation of the wheel just equal to the greatest possible friction between the wheel and the rail. This greatest possible friction occurs when the adhesion of the wheel to the rail is just about to be overcome by the superior effect of the brake shoe, which effort, if further increased immediately begins to stop the rotating movement of the wheel, causing it to slide upon the rail. When a wheel slides upon the rail its retarding effect is most materially lessened.

At 60 miles an hour, or such high speed, the maximum force with which the brake shoes can be pressed against the wheels of each vehicle should be at least one-and-three-quarter times the weight of the vehicle on those wheels. Even for slower

trains the effect of steep grades must be considered, which is equivalent to added weight and momentum of the train to be retarded by brakes, while it does not add to the adhesion of the wheels.

#### Conditions Required in Good Brakes.

The evidence of the Galton-Westinghouse tests was, that a perfect continuous brake should comply with the following conditions:

1st.—It should be fitted to act upon each wheel of the engine, tender and every other vehicle in a train of any length.

2d.—However brought into action, it should be capable of exerting upon the shoes of each pair of wheels, within two seconds, a force of twice, or at the very least one-and-three-quarter times, the load on those wheels.

3d.—The brake-shoe pressure acting on each wheel should be so regulated that the friction between the brake shoes and the wheel may always be limited so as not to exceed the adhesion between the wheel and the rail; by which means it will produce the maximum effect at each moment of its application.

4th.—The brake-shoe pressure should be capable of being applied by engineer or by conductor.

5th.—The engine, tender and vehicles should each carry their own store of brake power, which should be independent of the brake power on any other vehicle.

6th.—The brake-shoe pressure should be automatically applied to every vehicle by the separation of the train into two or more parts; and it should also be applied by a pair of wheels or a carriage leaving the rails.

7th.—The brake-shoe pressure should be automatically applied by such failure of the connections or appliances as would render it afterwards incapable of application until the failure had been remedied.

8th.—The brake-shoe pressure should be capable of application with any degree of force up to the maximum; and it should be capable of continued action on inclines, or of repeated applications at short intervals at junctions and stations.

#### Demand for Continuous Brakes on Freight Trains.

As the air brake came to be a recognized necessity for the control of passenger trains, the managers of various mountain

railroads began to perceive that it would be a valuable means of controlling freight trains and several of them proceeded to apply the air brake to most of their freight equipment. The Denver & Rio Grande Railroad management took the lead in this movement.

Freight cars provided with air brakes were soon found rambling all over the continent and every one of them became a silent missionary, advocating the use of continuous brakes on all trains.

With the increase of sentiment favoring the general introduction of continuous train brakes, the owners of a multitude of mechanical brakes proceeded to urge their appliances upon railroad companies, most of them making the claim that their brakes could be applied at much less expense than the air brake while being quite as reliable. Railroad mechanical officials have been noted for their steady advocacy of uniformity in train equipment and their influence was quietly exerted against mechanical brakes.

#### **Master Car Builders to Advise on Brakes.**

As agitation increased in favor of power brakes being applied to freight trains, a sentiment arose that the Master Car Builders' Association could deal with the question with justice to all concerned. As early as 1870 a committee of that association was appointed to investigate the subject of train brakes, but little of any consequence was done for many years. In 1882 a report on Continuous Brakes for Freight was submitted. The committee reported that air brakes were suitable only for short freight trains, as the following objections were submitted:

1st.—The liability of the brakes getting out of order by lying idle at stations or on side tracks.

2d.—The necessity of transferring all cars to the rear, or throwing them out of the train when the brakes failed to work.

3d.—The time required to release the brakes after each application.

4th.—The necessity for running short trains.

5th.—The necessity for having all cars equipped with the same brake on all roads offering cars for interchange.

6th.—An electro-magnetic brake and a bumper brake were referred to favorably.

### Burlington Brake Tests Proposed.

Several half-hearted reports were submitted from year to year, but in 1886 Godfrey W. Rhodes made a report in which he stated that the committee of which he was chairman had arranged to make very thorough brake tests at Burlington, Ia., beginning on July 13. The tests will, he said, consist of three series. The first will record how each brake, while new and in good order, acts in stopping a train under similar conditions. The second will be an endurance test to show how each brake stands the ordeal of regular service. The third will show how the brakes do their work after the parts have somewhat worn. Six competitors had entered.

The companies that entered for the 1886 contest were:

1st.—The Westinghouse Automatic Air Brake Company, Pittsburgh, with a train of 50 40,000-pound box cars.

2d.—The Eames Vacuum Brake Company of Boston, Mass, with 50 40,000-pound box cars.

3d.—The American Brake Company of St. Louis, with 50 40,000-pound box cars.

4th.—The Widderfield & Button Brake Company, Uxbridge, Ont., with 50 40,000-pound box cars.

5th.—The Rote Brake Company, Mansfield, O., with 50 40,000-pound box cars.

These five competitors represented two classes of brakes: the continuous or air brakes being represented by the Westinghouse and the Eames, and the independent or buffer brakes by the American, the Widderfield & Button and the Rote.

### Contest of 1886.

The history of the Burlington Air Brake contest in 1886 may be told in a few words. The trials were carried on from July 13 to August 2, and the only thing plainly demonstrated was that none of the brakes tried was capable of making emergency stops safely with a 50-car train. It was also proved that buffer brakes were worthless and none of that class was entered for further contest. The Westinghouse Air Brake and the Eames Vacuum kept on to the finish, but the performance was far from being satisfactory. The acknowledged result of that contest was the conclusion: "That buffer and friction

brakes were very unreliable for handling long trains and that the air and vacuum brakes tried were too slow in action."

The contest was renewed again at Burlington, May 9, 1887. This time five brakes competed: The Westinghouse, the Eames, Carpenter, the Hanscome and the Card. All of these had electric attachments for making emergency stops with 50-car trains. They all worked satisfactorily with the aid of electricity. An improved triple valve had been applied to the Westinghouse train but it did not make smooth emergency stops without the electric auxiliary.

The result of these tests induced the committee of the Master Car Builders' Association to report that they considered an electric auxiliary was necessary for use on air brakes required to handle 50-car trains.

### Cause of Air Brake Failure.

The failure of the automatic air brake was due solely to the time required to cause an operative reduction of the air pressure in the train pipe, sufficient to operate the triple valves upon the cars at the rear end of the train, by discharging the train-pipe air through the engineer's valve upon the locomotive. Efficient and satisfactory as had been the automatic air brake, upon even the longest passenger trains, the time required to cause the brake shoes to be applied to the wheels of the fiftieth car was about nineteen seconds after the brake shoes had been applied to the wheels of the first car. The very material retardation of the forward part of the train, by the application of the brakes so long in advance of their application upon the rear cars, resulted in destructive blows and shocks, as the unimpeded rear cars successively plunged forward into the stopping cars ahead.

Meanwhile George Westinghouse did not consider himself vanquished in the effort to provide an air brake that would handle any train successfully without the aid of electricity and he proceeded to solve the problem. He effected certain changes on his apparatus with the view of quickening the application of the brake to such an extent that the application on the last car would occur before the slack could run in. By a modification of the triple valve of the automatic brake, in the addition of another valve, each triple valve operated as an additional train-pipe vent valve, whereby the train-

pipe air was discharged, and its pressure lowered, at each car, instead of at the locomotive alone, and the brake shoes were thereby applied to the wheels of the fiftieth car in but about two-and-one-half seconds after their application to the wheels of the first car. A brief reference to the remarkable ingenuity of this feature of what then became known as the "quick-action" air brake will be pardoned.

The elasticity of atmospheric air defines the rate at which a vibratory impulse may be transmitted, from particle to particle, throughout a volume of air; which has been accurately determined, in the well-known rate with which sound is found to travel through the atmosphere, of about 1,120 feet per second. This is the greatest velocity with which any physical operation may be propagated or communicated through an expanse of atmospheric air; and the successively repeated mechanical operation of the triple-valve mechanisms, by which an impulse is instituted and propagated, through a body of compressed air, confined in a comparatively small pipe, complicated by bends, turns, cocks and hose couplings, to the next triple valve, by the operation of which the impulse is repeated, so that but about two-and-one-half seconds are required in producing 49 repetitions of the mechanical operation and in propagating the repeated impulse through 1,900 feet of the train pipe, is an almost inconceivable accomplishment. By this means the application of the brakes throughout the train occurred so nearly simultaneously that the shocks produced in an emergency application of the older automatic brake were avoided.

An incidental feature, of great importance also, was the utilization of the train-pipe air, vented by the new form of triple valve. As the discharge of train-pipe air, in this operation takes place through a large port almost instantaneously and before the auxiliary reservoir air has been discharged in material quantity through a comparatively small port into the brake cylinder, the train-pipe air is discharged into the empty brake cylinder, and thereby the ultimate pressure of the air in the brake cylinder, received from both sources, is about twenty per cent. greater than that which can be provided by the auxiliary reservoir alone.

The quick-action brake is, therefore, practically the old automatic brake, which operates with entire satisfaction for all

ordinary brake service upon even the longest trains, together with an added emergency brake which, when necessity demands it, applies the brakes almost instantaneously throughout the entire train with a force considerably greater than could be satisfactorily employed in the ordinary everyday brake service. The quick-action air brake has become the standard for freight service, and is now in operation upon practically all freight trains in this country.

A further development of the air brake is one which provides an efficiency superior to that of the quick-action brake for use upon high-speed passenger trains. In the Galton-Westinghouse experiments, already described, the static friction between the wheel and the rail, by which the wheel is caused to rotate, was found to be practically the same at all speeds. But the dynamic friction of the brake shoes upon the rotating wheels was found to vary inversely with the speed, being materially less with the same pressure upon the wheels at high speeds than at low speeds. Such a condition as this, by which the force which causes the wheel to rotate is the same at high speed as at low, while the retarding force caused by the friction of the brake shoes is less at high speeds, established the importance of employing a greater pressure of the brake shoes upon the wheels at high speeds to compensate for the inferior co-efficient of friction.

The apparent difficulty of regulating the brake-cylinder pressure, so that one suitable for high speed should become reduced, before the speed of the train became sufficiently reduced to cause sliding of the wheels thereby, resulted in no practical utilization of this principle until years afterwards, when the conditions of fast passenger service, in this country, appeared to demand greater brake efficiency than that afforded by the quick-action brake.

About the year 1891, the "high-speed" brake was introduced into service upon high-speed passenger trains, and has since become applied to a large number of trains of that class. It consists merely of the quick-action air brake, with the addition of an automatic brake cylinder reducing valve, by means of which the air pressure is not permitted to exceed the ordinary limit in service applications of the brake, but which permits a considerable higher brake cylinder pressure to occur in the beginning of an emergency application and automatically





Westinghouse Works at Wilmerding. "The Home of the Air Brake"

reduces that pressure to a safe limit when the speed of the train has become materially reduced.

### **The Westinghouse Type P Triple Valve for Controlling the Operation of Air Brakes.**

This type of plain triple valve may be said to be the earliest practical form of this class of valve for controlling the operation of automatic brakes. Briefly, it consists of an enclosing body or case in which the operating parts are contained and which is termed the triple valve body. This triple valve body has threaded openings at three points in the case, one of which connects with a line of piping extending throughout the train and termed the "brake pipe." The second of these openings connects with the auxiliary reservoir and the brake cylinder, which are usually combined in one. In the triple valve body there is fitted a slide valve which is operated by a piston. When the pressure of the air in the brake pipe is increased the auxiliary reservoir is charged, and the air in the brake cylinder is released to the atmosphere; and when the air pressure in the brake pipe is diminished, air from the auxiliary reservoir is discharged into the brake cylinder for applying the brakes. Such a triple valve performing these functions is termed a plain triple valve. It is now almost obsolete because of its many limitations in effecting braking operations, chief of which is the fact that its operation is not simultaneous on a long train. It was mainly employed on trains up to five cars in length in passenger service and up to twelve cars as a maximum in freight service.

The type of triple valve which is now almost universally used in modern railway service is termed the quick-action triple valve. The quick-action triple valve has all the features of the plain triple valve, and in addition performs the function of effecting a discharge of air from the brake pipe to the brake cylinder when in the event of emergency the maximum force of the brakes is instantly demanded.



J. W. CLOUD      CAPT. FAYV      SIR HENRY TYLER      GEORGE WESTINGHOUSE      SIR RICHARD POLLOCK      H. H. WESTINGHOUSE      ALBERT KAPTEYN  
OFFICIALS OF THE WESTINGHOUSE AIR BRAKE COMPANY

# Special Forms of Locomotives

## CHAPTER XXIX.

### Thought One Type Good for Any Service.

For years after railway operating began a belief existed among the managers and promoters of these enterprises that one kind of locomotive would be suitable for any kind of service, motive power was required to perform. That idea was soon dissipated, especially in England where a theory was early propagated that huge driving wheels were necessary to maintain a speed of thirty miles an hour. This led, very shortly

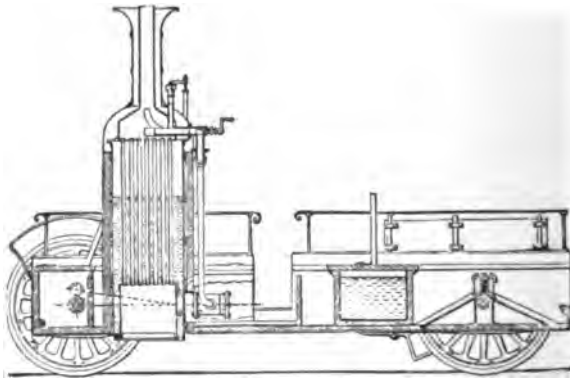

Fig. 257. Adams' Light Express Locomotive

after locomotives were introduced, to the designing of engines adapted to the two forms of traction. It was different in the United States except on the comparatively small number of railroads that had heavy mineral traffic, or had fast express trains. For many years the majority of railroads had one type of locomotive which was equally adapted to pull passenger or freight trains. That was the much admired 4-4-0, popularly known as the American locomotive.

The ordinary designs of road locomotives have been exhaustively discussed, and I shall now devote attention to special forms, such as those adapted to suburban business and to mining and purposes for which the old forms were not suitable.

When railroad managers first began to hold that there was too much weight of locomotive for the trains to be hauled some experiments were made with a combined locomotive and carriage. This scheme was tried in Britain and in the United States, the experiments on this side of the Atlantic having been made exclusively on street or highway railways. The first attempts of the kind in England were carried on somewhat persistently by W. Bridges Adams on the Bristol and Exeter Railway, the locomotive and carriage being shown in Fig 257. A combination locomotive and carriage of larger size was built for the Eastern Counties Railway about 1850, and claims were made that substantial saving of fuel resulted from using the combination. Railway engineers of that day were, however, so critical and of little faith that they insisted on putting the

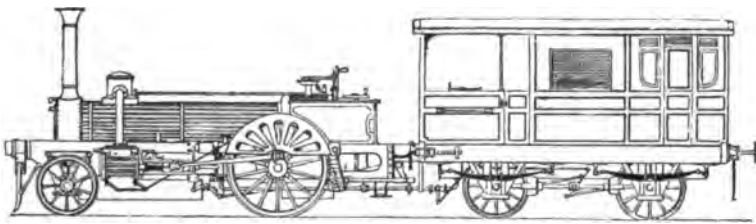

Fig. 258. Adams' Express Engine and Car

“Little Wonders,” Liliputians and Midgets to comparative tests with locomotives of full growth, with the result that the dwarfs fell into disrepute.

The tank style of locomotive soon became very popular in the British Isles and they practically monopolize the short run trains that are so numerous about large cities. But it soon extended to other train service. The great suburban traffic of the city of London is handled almost entirely by tank locomotives of various designs hauling very heavy trains. The same is true of nearly all large cities in Europe. But their greatest popularity is in England.

On that style of engine having a short radius of journey, extended conveniences were provided by putting water tanks alongside the boilers and saddle tanks were sometime applied. Those forms of locomotives were used not only for suburban trains but they came gradually to be largely used on branch lines, for which they are particularly well adapted

as they spared the delay and inconvenience of going to a turntable at the end of each trip.

When a railroad in the United States began to have sufficient passenger traffic about large cities to call for trains for the accommodation of people going to or from business, old road locomotives were considered satisfactory motive power. Traffic of this kind was not courted by railroad companies. It was forced upon them by circumstances and the railroad officials devoted very little time or attention to the cars used for suburban traffic or the locomotives that hauled them. The horse and his cousin, the mule, seemed to be the natural motive power for street and suburban lines, and no one could honestly accuse steam railroads of having imposed themselves or their locomotives upon the business.

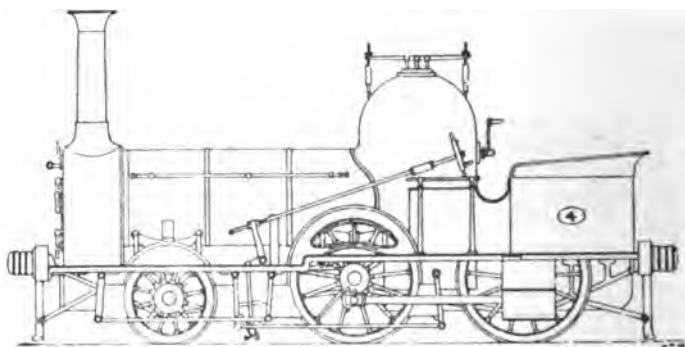

Fig. 259. Rebuilt Bury Locomotive

It is curious to witness the stupendous results that sometimes spring from what were originally very small causes. A distemper among horses stimulated the demand for suburban railroads that could be operated by locomotives to such an extent that the building of elevated railroads resulted.

During the summer of 1872 there was an epidemic of disease among horses in all large cities in America. The conditions resulting set the active brain of Matthias N. Forney into action, and he invented the locomotive illustrated in Fig. 263 as a means of overcoming the difficulty.

In offering that style of locomotive to railroad companies Mr. Forney said "that it was obvious that steam power must soon supersede horses on all railroads in large cities. Most of the people in large cities are now drawn from their business to

their homes like pigs, and the animals that draw them are literally tortured to death, for overwork is torture of the worst kind.

“In a large proportion of the attempts which have hitherto been made to use steam on street roads, the engine has been attached to the car, and, therefore, if one becomes disabled or needs repair, the other must be laid up at the same time. Besides this inconvenience, it is also obvious that a passenger car should be entirely separated from the grease, dirt, heat and smoke of the engine, and the latter like a horse should be capable of being attached to any vehicle. All the so-called dummy engines have, therefore, become unpopular, and, in a large majority of cases, have fallen into disuse. It therefore seems obvious that the motive power for street and suburban roads

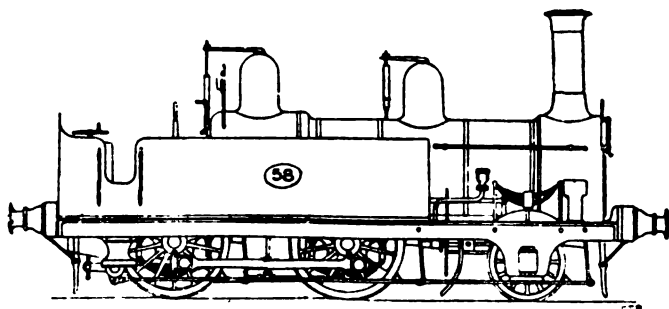

Fig. 260. Growth of the Tank Locomotive

should be quite separate from, but capable of being attached to, any car, and of being housed and cleaned and repaired by itself. That such engines, if carefully and skilfully designed, might be adapted for service on street roads there seems little reason to doubt.”

The design of engine shown in Fig. 263 is intended for roads which do a light traffic and run frequent cars or trains. A vertical boiler is arranged with the machinery in such a way that all the weight is carried on the driving wheels, and is thus available for adhesion. The water and fuel are carried on a leading truck. By this arrangement the permanent weight of the locomotive rests on the driving wheels, while the water and fuel, which vary in quantity, are carried on the truck. One great difficulty with tank locomotives is, that the tank filled with water and a full supply of fuel, if their weight is carried

on the driving wheels they must carry an excessive load, and when the fuel and water are nearly exhausted there is too little weight for adhesion.

“Locomotives on this plan can be built of almost any capacity, from a few tons up to twenty tons weight, and the smaller sizes can be made to traverse curves of from 30 to 40 feet radius.”

There is a saying among the ordinary run of business men that there is no use in offering an article for sale until there is a demand for it. The people operating light railroads in the United States were not asking for an improved locomotive for hauling light trains. They were satisfied with feeble animals and dilapidated switch engines that had eluded the scrap heap. But M. N. Forney convinced these people that they needed

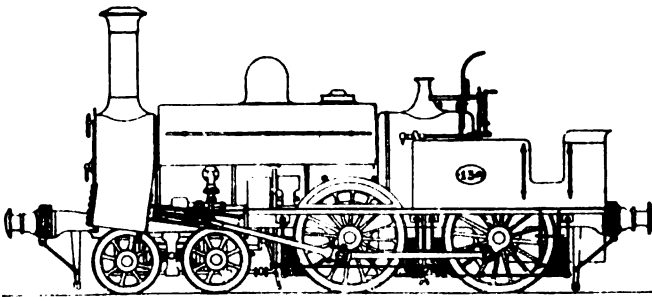

Fig. 261. Saddle Tank Suburban Locomotive

decent suburban engines, and his tank engine gradually came into popularity.

It first made its mark on the elevated railroads of New York, and became the recognized motive power for elevated railroads until it was superseded by electric traction. The intention originally was to operate the New York elevated railroads by cable, but that proving unsatisfactory small four-wheel saddle tank engines, Fig. 262, were employed for a time. These subsequently gave place to small Forney engines.

When any public works are proposed for New York City, or are in course of construction, the people in charge are always overpowered with loads of advice tendered to them by scientific men of leisure who never tire of interfering with the plans, arrangements and appliances. The motive power which ought to be employed on the elevated railroads of New York became for a time the subject of most acrimonious discussion.



Various mechanical engineers, novice engineers and locomotive designers strove to supply the kind of engines best adapted to operate elevated railroads, which presented a new engineering field. As mentioned, small four-wheel locomotives were tried but found wanting. To a person of common sense, supplemented by a little engineering knowledge, the Forney engine made an ideal form of steam power for elevated railroads, and the engine eventually won on merit.

The scientists who devoted pleasant leisure to fault-finding with the operating of the New York elevated railroads sometimes blundered badly in estimating the power used for moving trains. One of these gentlemen pestered the management for a long time to be permitted to use a thirty-five horse-power electric motor to operate a train on one of the lines. When the



Fig. 262. First Elevated Railroad Locomotive

electric inventor was becoming importunate the management of the Manhattan Railroad Company engaged the writer to make tests that would demonstrate the amount of power developed by the steam locomotives in doing the work. Under certain conditions they exceeded one hundred horse power.

### Matthias N. Forney.

The designer of the most successful suburban engine ever introduced deserves a prominent place in this chapter. Matthias N. Forney, one of the most celebrated mechanical engineers in the world, was born in Hanover, Pa., in 1835, of German stock.

His father died when Matthias was 12 years old, leaving the mother with three sons and three daughters. Hanover, having very indifferent school facilities, Matthias was sent, when 14 years old, to a school in Baltimore which was something of a high school character. He entered the shop of Ross Winans

as an apprentice in April, 1852. He spent three years working in the shop and then one year in the drawing office. At the end of his apprenticeship, he secured a position as draughtsman in the shops of the Baltimore & Ohio Railroad, then under charge of Henry Tyson. He continued in that position for three years.

Thinking that the prospects of success in life were very meagre on railroads, he left railroading and went into mercantile business in Baltimore, at which he continued for three years. A business career not being entirely to his liking, he returned to railroad work three years afterwards as draughtsman in the machinery department of the Illinois Central Railroad, then under charge of Samuel J. Hayes.

While engaged on the Illinois Central, he designed what is



Fig. 263. First Forney Locomotive

known as the "Forney Locomotive." After three year's service with the Illinois Central, he went to be draughtsman with the Detroit Iron and Bridge Works, but remained with the bridge company only a short time, having been engaged by the president of the Illinois Central Railroad to superintend the building of some locomotives under construction at Hinkley & Williams Works, in Boston. This was in the spring of 1865, and occupied Mr. Forney for about six months. On the completion of the engines he remained with the Hinkley & Williams Works partly as designer and partly as traveling agent. He was with them for about three years. In 1870 he accepted the position of associate editor of the "Railroad Gazette," which was then published in Chicago. The great fire having occurred in 1871, the office of the "Gazette" was moved to New York. Soon afterwards, H. W. Dunning, who was editor-in-

chief, and Mr. Forney bought each a half interest in the paper. Mr. Forney's department was that of engineering and mechanical matter, while Mr. Dunning had charge of transportation and traffic. In 1873, Mr. Forney began writing what had become known as "The Catechism of the Locomotive" which was run through the "Gazette" in serial form, and afterwards published in book form. It was rewritten ten years later, and has been one of the most popular and useful publications ever prepared for railroad men. Mr. Forney joined the Master Car



Matthias N. Forney

Builders' Association as an associate member early in its history, and in 1889, through his influence the Association was reorganized so that it would be more in touch with railway officials and railroad companies.

Mr. Forney left the editorial chair at that time. Three years later, having become tired of a life of leisure, he bought the "American Railroad Journal" and "Van Nostrand's Engineering Magazine," and consolidated the two under the name of the "Railroad and Engineering Journal." That paper he published and edited until the end of 1895, but changed its

name in the beginning of that year to the "American Engineering and Railroad Journal."

He says invention has always had a great fascination for him. It is akin to the passion which the fortuity of the dice has to the gamester, and once having developed the taste for invention its allurements had led him on as readers will be assured, "by the following list of patents which have been granted to me, and which will indicate the subject in which my efforts to improve things have been exercised." Then follows a list of 33 patents most of them for appliances intended to improve the locomotive.

His confession about why he remained a bachelor is some-



Fig. 264. A Full Grown Farnley Locomotive

what amusing. He wrote: "Perhaps some men and old women who see these notes will be curious to know why no woman was ever asked to share my joys and sorrows. It would not be difficult to give an answer, which would be somewhat like this: During the impressionable period of my life I could not afford to assume such partnership. When things went better with me my time was too much occupied to give the matter my attention, and later by reason of age, attractive women would not smile on me. It would do no good to admit now that it was a mistake to live alone, but it is also true that celibacy has its compensations."

Matthias N. Forney is a fertile inventor and an accomplished designer of railroad appliances; but his fame will rest upon his work as an engineering journalist and author. During all the time he occupied the editorial chair of the "Railroad Gazette" there were constantly engineering heresies arising such as the narrow gauge mania and the Fontaine locomotive idiocy, and he was always found on the right side, advocating common-sense and sound engineering. His "Catechism of the Locomotive" has been the instruction book of thousands of railroad men, and will hold a high position as long as steam locomotives are operated.

### **Baldwin Special Locomotive.**

Following what seemed to be an opportunity for expansion of locomotive building in 1876 the Baldwin Locomotive Works turned out some steam street cars. After experimenting to find the most efficient, comfortable and durable form of steam street car they worked into a fair business in this line.

About the same time a demand began to arise for special forms of locomotives to operate very steep grades and Baldwin's people met the demand by the production of a variety of odd looking engines. The stunted looking motor shown in Fig. 265 was one of two rack rail locomotives on what is known as the Rigenbach system, one with a single cog wheel and four carrying wheels, and weighing in working order 32,000 pounds, for the Colorado Railway of Brazil. The other, weighing in working order 79,000 pounds, was for the Estrada de Ferro Principe de Grao Para, Brazil, the general outline being seen in Fig. 266. This engine had two cog wheels and eight carrying wheels.

In 1890 the Baldwin Locomotive Works built their first locomotive on the Abt system for Pike's Peak Railway and they have been building engines of that kind ever since.

### **H. K. Porter Company.**

The ordinary locomotive builders have turned out many curious and interesting locomotives for special purposes, but I am now going to tell something about a concern that has been in business for forty years building industrial locomotives of every variety that run on wheels. This is the H. K. Porter Company of Pittsburgh, Pa. They began building locomotives in 1866 and for years their principal output went to contractors and narrow gauge railroads, but by degrees they worked more

intimately into mine motive power and they build more locomotives for mining purposes than any company in the world. Their specialty is now compressed-air motors, and of these they build a great variety.

The company is noted for the high-class work put upon the engines and for the superior material employed. In this connection, one peculiar and important feature of construction, which is specially applicable to narrow gauge, industrial and steel works engines of any size, say 9x10 inches and larger, is their stopped-off frame construction. They make all their frames of best quality forged iron, feeling that for that class, where the conditions are most unusually severe, steel castings for the main locomotive frames are altogether too unsatisfactory, too unreliable, although, of course, they are cheap. They use a steel casting, however, in the shape of a very heavy, massive cross brace and tie plate to



Fig. 265. Riggensbach Rack Rail Locomotive

which the main frames are attached, and also the rear extension of frame connected, admitting a boiler on narrow gauge of full width, with straight sides, and giving a very large fire-box, making a free steaming and most exactly balanced locomotive.

Illustrations of some of the earliest locomotives built in these works are given in Figs. 267 to 370. All of these locomotives were built long before the days of steel boiler plate, and before steel tires had come in general use. The frames were slab forms, each pair of frames being cut out of a single slab of iron, the pedestals being of cast iron and riveted on to the frames. Only a short time ago one of these engines, built in the year 1867, was still running and doing regular work.

The H. K. Porter Company's Works were located in the city of Pittsburgh where there were no facilities for shipment by rail, and the people in charge sometimes experienced much difficulty in transporting the engines to a shipping point. The

locomotives for shipment were run out of the front door of the shop into the city street and on to a makeshift turntable, the engine turned around and run on portable track, which was moved ahead by a horse as fast as the engine traveled ahead under its own steam. The turntable was then put at another cross street about two blocks away and the tracks continued to the river bank, where an incline plane was made of heavy timbers and the engine let down by its own steam onto a flat boat and towed to the foot of Liberty Street, where it was hauled up the bank on portable track by a Pennsylvania Railroad switch engine and loaded on car for shipment. One of the earliest of these locomotives was run by its own steam through the city streets, the double track of the horse-car railroad being used, as the engine just happened to fit in gauge the two nearest rails of each track.



Fig. 266. Brazilian Mountain Locomotive

### **Locomotive Classed as an Elephant.**

This was in the days of the old Monongahela River suspension bridge, one of the very first built by Roebling, and the tollkeeper had no classification of tolls on locomotives, and is said to have classified it as an elephant. Another ancient locomotive was shipped on a flat boat by water, the side rods being disconnected from the front driving wheels and run backward and attached to long wooden beams, which were fastened to the stern paddle wheel, turning the locomotive into a steamboat engine, and in this way the engine was navigated to a distant port on the river without rail connection. The flat boat drew only three or four inches of water and happened to go down the river at a period of low water, and the engine awakened a great deal of interest along all the river towns, who were anxious to know how much water the crew found on various shoals.

Those were pioneer times and the embarrassing events are now merely pleasant reminiscences.

Although the company still build many steam locomotives, their principal business is now the building of compressed-air locomotives. The first compressed-air locomotives were built in 1890. These early compressed-air locomotives were crude in many respects, but many of them are still running regularly, doing good work. In 1895 compressed-air locomotives were built having all the essential features of the most recent productions. Since that time many practical improvements in details have been made; among them increased pressure in the main storage tanks and an improved type of automatic reducing and stop valve for maintaining a uniform pressure at the throttle valve. Not only the locomotive, but the compressor, pipe line, charging stations, valves



Fig. 267. Early Porter Locomotive

and fittings have all been examined and analyzed with a view of effecting improvements that will make compressed-air motive power as efficient as it can be made. Defects and weaknesses have been eliminated till failures with this kind of machinery are now almost unknown.

The demand for compressed-air locomotives has made wonderful advances in the last few years; so rapid, in fact, has been the increase in purchases that the H. K. Porter Company have been very much behind in meeting orders; but the facilities have been increased to deal with the growing business which will go on steadily as people using this kind of motive power become convinced that the compressed-air locomotive has passed the experimental stage.



As the H. K. Porter Company have had more experience with compressed-air locomotives than any other manufacturer, I will repeat claims they make concerning this great industry as follows:

### The Field for the Compressed Air Locomotive.

We have obtained most satisfactory results with compressed-air locomotives under a great variety of conditions. We have built them for gauges of track varying from 18 to 56½ inches, for grades from level up to 10 per cent., for curves as sharp as 15 feet radius, and for trains varying from a few thousand pounds to four or five hundred tons, and for hauls varying from a few hundred feet up to three miles. Our underground installations in-



Fig. 268. Porter Locomotive, 1868

clude haulage plants for anthracite and bituminous coal mines, both gaseous and non-gaseous; for main haulage work with heavy trains, and also for the lighter work of gathering coal from the working faces in single cars and light trains. For surface work we have installed our locomotives not only in places where a reduction of the fire risk was an important consideration, as at woodworking plants, lumber yards, magazines for storage of explosives, and powder yards, but also at points where the fire risk introduced by the use of steam or electric locomotives was unimportant, and where compressed-air locomotives were adopted because of their general utility, economy and reliability, as, for

instance, at malleable iron works, gas works, copper reduction works and mills for the refining of precious metals.

The above statements serve to indicate what has been done, but we feel that the field of the compressed-air locomotive is capable of being still further extended, and that as it becomes better known to the engineering world, its use will become more and more general. Our installations include small plants with single locomotives and larger plants with from six to thirteen locomotives operated from one central power station. We have installed them at coal mines, where fuel was a secondary consideration, and the crudest type of steam engine was used to drive the compressed-



Fig. 269. Early Porter Locomotive

sor, and at points in the Far West where fuel was very expensive and the highest type of compound condensing engine was used for the generation of power.

#### **Essential Features of a Compressed Air Haulage Plant.**

1. One or more compressed-air locomotives of proper design and capacity to suit the conditions.
2. One or more air compressors of sufficient capacity.
3. One or more charging stations.
4. A storage system (usually a pipe line) of suitable capacity and properly designed to admit of placing charging stations at convenient points.

5. Last and most important, all parts must be properly combined to form a satisfactory working plant as a whole.

### Reliability.

A haulage system that can be depended upon to work all day and every day in the hands of workmen of ordinary ability is a reliable system. Other qualities are desirable, but reliability is a necessity. In developing our system of haulage by compressed-air locomotives we have kept the vital importance of this quality constantly in mind, and have never lost sight of it in our efforts to reduce the selling price and secure a high mechanical efficiency.



Fig 270. Porter's Early 4-4-0 Locomotive

Persons not practically familiar with air haulage frequently have the impression that serious difficulty is to be anticipated from freezing in the exhaust passages of the locomotive. Compressed-air locomotives have been used for thirteen years, and no such difficulty has developed. This difficulty is suggested by the freezing which frequently occurs when air is used at lower pressures. With the higher pressures used in connection with locomotives this difficulty is eliminated, as practically all of the moisture is squeezed out of the air in the process of compression and deposited in the stationary storage or in the tanks on the locomotive, where it can be drawn off at convenient times. The outside of the locomotive cylinders and valve chests becomes cold and frequently coated with frost, and the exhaust, when it comes in

contact with the outside air, condenses moisture in it, producing an appearance similar to that of low-pressure steam, which almost immediately disappears; but there is no moisture in the working parts of a compressed-air locomotive, and if a suitable oil is used there is nothing inside the locomotive which can be frozen.

As compared with all other systems, the machinery of a compressed-air haulage plant is simple, strong and accessible, with the power limited by the design, and hence capable of being worked up to its full limit without danger of breakage or liability to the frequent temporary delays which are so annoying in connection with the operation of many of its competitors.



Fig. 271. Porter's Modern Switcher

### Adaptability.

Compressed-air locomotives are more easily operated than steam locomotives, as the skill necessary to preserve a steam boiler in proper condition is entirely eliminated. Compressed-air locomotives are an every-day working success, with all the good features of the electric storage battery locomotives, and some others of their own, in that the tanks do not deteriorate as the batteries do, are not injured by shocks or excessive demands for power; they are compact, and can be built to conform to any ordinary limitations of height and width, as, for instance, in any place where mules can be used. Our compressed-air locomotives are capable of running from 3,000 to 15,000 feet with one charge of

air. These distances may be more than doubled by the use of a tender carrying an additional supply of air. A locomotive can easily be charged in from one to two minutes, and with charging stations located at convenient points, the radius of action for the locomotive with one charge of air is abundantly large for mining and industrial service, and there are no overhead or underfoot obstructions corresponding to the trolley wires of the electric system or sheaves of rope haulage.

These features make compressed-air locomotives exceedingly convenient for industrial service in mills and manufactories where traveling.

### Safety.

The economy, adaptability and reliability of air haulage de-



Fig. 272. Porter's Single Truck Compressed Air Locomotive

serve due weight in the choice of a haulage system, but under many conditions the positive safety of a compressed-air locomotive, as compared with any known form of motive power, should be decisively in its favor. As a matter of history, an examination of the records shows no deaths or injuries which can be in any way attributed to defects or weaknesses of this system. There are at the present time between fifty and seventy-five air haulage plants, each with one to thirteen of our air locomotives in everyday service, so that our claim that air haulage is safe is based upon a considerable mass of evidence. The high pressures used in connection with this system may seem to the uninitiated rather dangerous; but if the same factor of safety be maintained for 800 to 1,000 pounds pressure as is maintained with 80 or 100 pounds pressure, and if, in addition, the material used is not subjected to the injurious influences of fire, scale and corrosion, there is no

reason why 800 to 1,000 pounds should not be as safe as 80 or 100 pounds; and the result of an explosion with 800 to 1,000 pounds of air is not as dangerous as would be the case with 100 to 150 pounds of steam, as the air may bruise but it will not scald. If electric haulage could be made as safe as air haulage, or if air haulage had resulted in one-quarter as many deaths as has electric haulage, we feel certain that the facts would have been most thoroughly ventilated in the engineering and mining press. Even as it is, the claim is set up that while contact with an electric wire carrying 500 volts may sometimes be fatal to horses and mules, it is not fatal to men. The official records, however, show that this statement is unquestionably false, and conservative managers



Fig. 273. Porter's Compressed Air Locomotive

are now insisting upon a maximum limit of not over 300 volts wherever naked wires are to be employed with which men may accidentally come in contact. During four years, in ten collieries—mostly operated by one company—and all in one district of one State, eighteen men were killed by the electric shock. We have no data as to how many men during the same time may have come in contact with the wires and escaped with their lives.

### **The Growth and Development of the Lima Locomotive Works.**

Within thirteen years of a half a century ago the founders of The Lima Locomotive and Machine Company purchased the plant of Chapman-Donnelly & Company, situated on East Market Street, in the then small town of Lima, Ohio. This plant had been

manufacturing reapers, mowers, horse-powers and threshing machines, and had not been in operation for nearly two years prior to the said purchase.

The firm was first organized under the name of "Carnes, Harper & Company," but within a year the firm changed to "Carnes, Agerter & Company," Mr. Harper withdrawing from the firm. The new firm, immediately on purchasing the plant, began the manufacture of sawmills, general mill machinery and their direct-acting circular sawmills. The direct-acting circular sawmill met with great favor, and the firm soon had a favorable reputation established and were widely known among the lumber manufacturers of the different States.

The plant was operated under the above name for a number of years, gradually growing from year to year, until the year 1877,

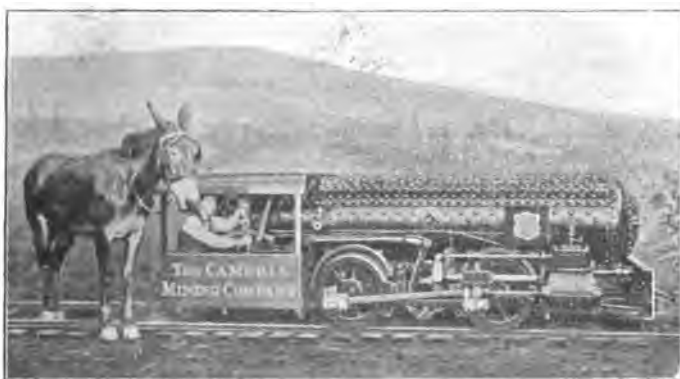

Fig. 274. Two Types of Air Motor

when the company was incorporated under the name of The Lima Machine Works. The new company took up work with greater activity, and the management, being very aggressive, found in mingling with their sawmill customers and friends that a more up-to-date method for handling the logs from the woods to the mill was needed, other than drawing them in on sleds during the winter season or hauling on wagons with oxen or teams. The locomotive and tramway was suggested and The Lima Machine Works was given the order to construct the locomotive, and the first direct locomotive was built and shipped in 1879; during the several succeeding years a number of locomotives were built, and along in the early part of 1880, it being found necessary to devise some better and cheaper scheme to provide for transporting the

logs, a lumberman in Northern Michigan, Mr. Ephraim Shay, took up the problem of constructing a locomotive that could be operated more cheaply and successfully on crude constructed railways and at the same time be adaptable to heavy grades and curves, such as were found to exist in the large forests. Mr. Shay's idea was that of the geared locomotive; and he being a user of the direct-acting circular sawmill, built by The Lima Machine Works, he approached the management of said company with his scheme and laid it before them; they, believing that there was merit in his suggestion, helped him to perfect the invention;



Figs. 275 and 276. Latest Forms of Porter's Compressed Air Locomotive

and in the latter part of the year 1880 the first locomotive, known as the Shay Patent Geared Locomotive, was built by The Lima Machine Works and sold to Mr. J. Bond, of Clam Lake, Michigan. The locomotive built is shown in original photograph illustrated.

This locomotive was built upon a wood frame, of regular car construction, a 44-inch upright stationary boiler furnishing steam power, the whole being carried upon two center bearing trucks of regular diamond frame construction, except that bevel gears were bolted to outside face of wheels on right side of trucks and a horizontal shaft with pinions pressed on same, engaging with gears on wheels, was provided for.



Power from the cylinder and crankshaft was transmitted to these shafts, through a flexible connection between trucks and crankshaft, consisting of universal joints and square shafts operating in sleeves to form a telescopic connection, the whole being substantially the same in principle as in the locomotives built at present.

Although a very crude construction, full of defects requiring many modifications, this first locomotive demonstrated the possibility of effecting a revolution in the method of marketing timber, because it met the following requirements:

First: The locomotive had a very short, rigid wheelbase, adapting it to sharp curves.

Second: A longer flexible wheelbase could be provided for than with any other type of locomotive, adapting it to rough and uneven track, both laterally and vertically.



Birds-eye View of the Lima Locomotive and Machine Company

Third: The weight was so well distributed that the engine could be operated on light rail, or wood track, under circumstances where it would be impossible to use any other type of locomotive.

Fourth: In most cases the railways constructed for lumber operations would be of a temporary character, not warranting the expenditure of large sums of money for construction. The use of the Shay locomotive made it possible to meet this condition, and locomotives therefore almost entirely superseded the use of horses and sleds for the work.

Fifth: The entire weight of the locomotive was carried on driving wheels, making it all useful for adhesion, there being no dead weight due to separate tender, which is quite an advantage in heavy-grade work.

Sixth: The locomotive was of such construction as to make it of moderate cost, yet withal a durable machine, easily kept in

repair and not requiring any very fine adjustments. The service and localities in which it was to be employed made this an imperative condition, the lumber operations being far from any machine shop facilities for making repairs of such nature as are usually required by other types of locomotives.

Seventh: Roads were built with wood track construction, costing \$150 to \$800 per mile. All engines built up to September, 1882, had wood frames, after which they were built with steel eye-beam frames.

These engines were all of two-cylinder, two-truck type, ranging from ten to fifteen tons' weight in working order. In 1884 a three-cylinder, two-truck locomotive was built to meet the demands of road requiring more power than previous engines would furnish. The use of three cylinders was based upon the theory that not only would there be less stress upon the working parts of each cylinder than would be the case if the same power was provided for in two cylinders, but the three cylinders would furnish a steadier power to the locomotive, due to two of the three cylinders at all times forming a couple to produce a turning moment on the crankshaft while the third piston was passing the dead point of the stroke. In practice this was so successful that it has been continued ever since.

The use of three cylinders also does away with the necessity for providing a counterbalance for the reciprocating parts, the engine being in perfect balance in itself.

Three-truck locomotives were not built previous to 1885, when a 20-ton, two-cylinder locomotive was built to work on a very light rail. In this engine the boiler and fuel were carried on the two forward trucks and the water tank on rear truck.

The Montana Union Railway ordered a 91-ton locomotive in 1890, built with three trucks, three cylinders, 16-inch diameter by 15-inch stroke, and wheels 40-inch diameter. The success of this engine on grades of 3 per cent. and 4 per cent. was conclusive, doing the work of three six-wheel connecting locomotives of 18-inch x 24-inch cylinders, with the same water and fuel consumption as one of the 18-inch x 24-inch engines.

The growth of the business was to such an extent that additional capital was found to be needed to successfully carry on the business. A stock company was formed, and in 1892 was incorporated under the name of The Lima Locomotive and Machine Company. This move gave the company renewed facilities and

extensions were added to the plant, making it better prepared to handle the increased business.

While the founders were still heavily interested in the business, the management was given up to the younger generation, and with a determination to succeed they forged ahead. Each year brought improvements to the locomotives being built, and with the improvement of the quality of the output, and in view of the fact that the markets of the world were in need of the special locomotive, the Shay Geared added facilities were found to be needed to more correctly meet the demands of the trade.

In 1901, to further meet modern conditions, an entire change in the management of the company was effected, younger men, many of whom had been trained for years in the modern school of business, assuming active control of the management of the affairs. The East Market Street plant was found to be too small to successfully cope with the great demand and the new management decided to move into larger quarters.

Shortly before the incorporation of The Lima Locomotive and Machine Company, the old company, The Lima Machine Works, purchased the old Lima Car Works plant, some fifteen acres in the south part of the city. The new company built cars for a few years after being incorporated, but they discontinued building cars and gave their attention to the building of locomotives entirely.

The present plant is designed with a view of competing with the largest locomotive builders in the country and to enable them to step into all the markets of the world, and is now turning out thirty locomotives per month.

They build direct-connected locomotives of all sizes and types for all classes of service, yet their principal product is the Shay Geared locomotive, which is especially designed for service on heavy grades and curves, and which is built in sizes from 10 to 150 tons.

The locomotives manufactured by this company will be found working in all parts of the globe—Australia, England, South America, Tasmania, Central America, Porto Rico, Cuba, British Columbia, Nova Scotia, Mexico and Japan. Foreign agencies have been established in all foreign countries, and the annual sales of said company now aggregate a sum of \$3,000,000, and the monthly pay-roll amounts to \$80,000.

The locomotives built at the time the infant company was established, compared with the final modern locomotives which they



Fig 277. Most Recent Form of Shay Locomotive

now turn out, appear in their pictures like curiosities. See illustrations.

It may be interesting to note here that in 1891 the attention of The Franklin Institute of Philadelphia was directed to the Shay Geared locomotive, by reason of reports of tests of the Montana Union Railway and other Shay locomotives, and the Sub-Committee on Science and Arts, of The Franklin Institute, made a report on the locomotive, under date of December 31, 1891. Extracts from this report are as follows:

“(a): The workmanship on these engines appears to be of a high order and the parts well proportioned. The gears are of steel and, with proper care, are said to last from three to six years, according to the work performed.

“(b): Your sub-committee considers the performances of these locomotives very remarkable, and they prove the power and efficiency of this style of locomotive under very trying circumstances.

“(c): It is difficult to estimate the value of such means of transportation as these engines furnish, but it must be very great. In lumbering and mining districts vast areas are brought into commercial reach that must otherwise remain undeveloped. In mountainous regions many points are made accessible that without expensive engineering works could not otherwise be reached.

“(d): Your sub-committee is of the opinion that the locomotive fully and satisfactorily meets the conditions for which it is designed, namely, great tractive power, cheapness of construction, adaptability to cheaply constructed roads in mountainous regions, at the same time showing a good degree of economy and efficiency.”

The John Scott Legacy Premium and Medal was awarded to the inventor of the locomotive by The Franklin Institute, on recommendation of the committee.

The entire development of the Shay locomotive, to its present modern efficient construction, is due to the efforts of The Lima Locomotive and Machine Company, most of the improvements being made during the past five years.

### Vulcan Iron Works.

Several other companies are engaged in the construction of special locomotives, among them being the Vulcan Iron Works, of Wilkes-Barre, Pa., which do an active business in making

mining and narrow gauge locomotives. Fig. 278 illustrates an ordinary specimen of their work. The company has good manufacturing facilities; they are situated in a region where the materials of locomotive construction are rising out of the ground, so there are good prospects of a prosperous future for the Vulcan Iron Works.



Fig. 278. Vulcan Iron Works Locomotive



Fig. 279. Davenport, Ia., Locomotive

### Davenport Locomotive Works

Are the youngest candidates for gaining fame and fortune by building industrial locomotives, but they start out in a spirit that generally compels success. Their guarantee, which is a promise of what customers may expect, reads: "Every loco-

motive built by us, whether so stipulated in the contract or not, is guaranteed by us to be built in accordance with our specifications, to be of the best workmanship and material, accurately constructed to our duplicate system and to develop the tractive force stated in the catalogue. Each individual part is guaranteed to be of good material and free from physical defects." Fig. 279 illustrates a locomotive built by the Davenport Locomotive Works.

# Locomotive Accessories

## CHAPTER XXX.

### The Steam Whistle.

As the whistle is frequently the most emphatic element on the locomotive engine, it will be interesting to outline its history, the more especially as silly stories have been circulated in America to the effect that George Stephenson invented the steam whistle because a farmer's wagon containing a load of eggs had been hit by a locomotive, spreading around a mess that was long in evidence.

The first steam whistle was applied to a locomotive by

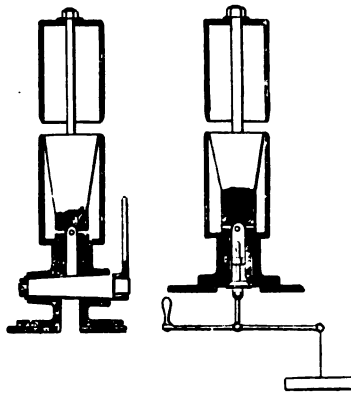

First Locomotive Cup Whistle, 1835

Sharp, Roberts & Co., Manchester, in 1833. It was in the form of a sportsman whistle and was not noted for its noise. In 1835, Sharp, Roberts & Co. sent one of their machinists named Thomas Turner to Dowlais Iron Works, South Wales, to put up some shafting. While there he found a cup whistle in use, the invention of a foreman named Stephens. Turner brought a sketch of the whistle home with him. On showing this to Mr. Fyfe, locomotive superintendent of the Liverpool & Manchester Railway, the latter perceived its value and adopted it without delay. The first locomotive shown with a cup whistle was made by Bury, in 1835.

Digitized by Google



### Safety Valves.

Engineering information manuals tell us that the boiler safety valve was invented about 1680 by Denys Pepin, a French savant residing in England. Pepin believed that an increased amount of nutrition could be obtained from meat cooked under high pressure and he invented for this purpose a utensil which he called a "digester," wherein substances could be boiled at any desired pressure. To prevent the pressure exceeding the strength of the boiler Pepin invented the lever safety valve in the simple form still found used on stationary boilers.

Pepin properly receives the credit of being the inventor of the safety valve because he put it into practical shape, but crude forms of relieving pressure had been in use for many years before his time. The liability of stills and retorts to be rent asunder by excessive pressure led chemists and distillers to apply plugs to openings made in the vessels used, that the vapor might raise or blow out when the pressure reached a certain tension. A conical plug loaded with a lead cap was a common form of safety valve used by chemists.

When the day of the working steam engine arrived, engineers had become familiar with Pepin's safety valve and it was used on all their boilers. The only improvement effected on the safety valve up to the time it was needed for locomotive boilers was the adding of a spindle beneath the valve which moved in a guide, tending to make the valve rise evenly off its seat. As a weighted lever was an unreliable arrangement to have on a boiler tossing over a rough track, the locomotive boilers were provided with a spring for weighting down the safety valve lever. That spring was inclosed in a brass cylindrical case graduated for different pressures. For years after locomotives came into use this, the "Salter," as the spring balance was generally called, was the only means the engineers had of telling the pressure of steam. The amount of effort necessary to lift the lever to permit steam to escape indicated to the anxious engineer how far the steam was below the blowing off point.

The weighted lever with disk valve with beveled seat did not form a reliable means of relieving the boiler from excess pressure of steam. The arrangement was not sufficiently automatic, for it frequently failed to relieve the pressure when

generation of steam was very active, and it was very sluggish in closing, so that it would often reduce the steam pressure before it stopped blowing. This led the way to the introduction of the pop safety valve, which is now used in some form on all locomotives. The history of this improvement is interesting.

### The Richardson Safety Valve.

In 1866, George W. Richardson, an engineer in the employ of the Troy and Boston Railroad, patented a spring loaded safety valve in which the steam, after leaving the ground joint, passed into an annular chamber, surrounding and attached to or forming part of the head of the valve, where it exerted additional pressure to raise the valve from its seat against the increasing tension of the spring. The passage way for the steam from this annular chamber to the atmosphere was restricted, and upon this depended the result obtained by the valve. These results were such as never had been obtained before in the use of the safety valve. Of this there has never been any question. Applied to a boiler, Richardson's valve would open sharply at the exact pressure at which it was set, blow rapidly and after reducing the pressure in the boiler by about two pounds close as abruptly as it opened, accomplishing this under ordinary conditions in a few seconds of time.

Comparison was hardly possible between this valve and other safety valves in use at that time. On locomotives and other quick steaming boilers, the old safety valve served little other purpose than to warn the attendant that the pressure was getting dangerously high, when they took means to assist the safety valve in reducing it. This was particularly true of boilers under motion, where for obvious reasons the valves must be spring loaded, and the spring opposed by increased tension as soon as the valve began to leave its seat; but it was measurably true of safety valves as applied to all classes of boilers.

One of Richardson's valves, of only a fractional part of the area of the old valve, would prevent the possibility of increasing the pressure in a boiler, even with the hardest firing, when the old valve would permit the accumulation of a dangerous pressure under ordinary firing. This was repeatedly demonstrated and is of interest as showing what Richardson gave to the public in his valves. By regulating the structure between the annular chamber and the atmosphere, by which the pres-

sure in the chamber (always of course less than the boiler pressure) would be correspondingly regulated, the valve could be made to close upon any desired reduction of boiler pressure, as little as one-half pound per square inch with boiler pressure of 125 pounds. Richardson's valve permitted keeping the pressure in a boiler substantially constant, effectually avoiding all danger of disaster by high pressure and loss from excessively reducing the pressure through the safety valve.

Richardson's valve almost immediately went into extended use, especially on locomotives. From the startling way it opened and closed railroad men called it a "pop" valve, a name it still retains.

The introduction of Richardson's valve led to litigation, which is historical and has formed a precedent in many patent cases that have no relation to safety valves.

The Richardson safety valve, having obtained quick popularity, attempts to evade the patents followed as a matter of course. The basis of evasion was the claim that, previous to the Richardson invention, efforts had been made, particularly in Great Britain, to construct a valve that should do what Richardson's valve accomplished and that patents had been granted upon several such valves in England, and that one of the English inventors had patented his valve in this country. Nothing, generally speaking, was known about these valves, because, utterly failing in their purpose, they never passed beyond the experimental stage. Several of them would prevent the accumulation of steam beyond the point at which they were set to blow, but having begun to blow they would continue it until the boiler pressure was reduced from twenty to fifty per cent. This rendered them not only valueless, because they would reduce the pressure below that required to do the work, but extremely wasteful of steam and dangerous in that they would submit the material of the boiler to sudden and damaging changes of temperature. These valves possessed one feature in common with Richardson's, viz.: a surface for the steam to act upon after leaving the grooved joint. But they lacked the structure that should confine the steam just sufficiently to overcome the increased tension of the spring, but not sufficiently to prevent the spring from promptly closing the valve upon a slight reduction of the pressure in the boiler.

So far as utility as a safety valve adapted for use on a boiler furnishing steam regularly, as for a steam engine, was

concerned, valves constructed after these English patterns were just about as valuable as a plug so fastened in a boiler shell that if a certain pressure is exceeded it will blow out and empty the boiler of steam.

It was soon found by those who sought to evade Richardson's patents that, by additions in the light of his achievements, valves constructed after some of the rehabilitated English patents could be made to work with reasonable satisfaction. Not long after the introduction of Richardson's valve, E. H. Ashcroft began to manufacture safety valves under a re-issue of Naylor's, an English patent, claiming that Richardson's was subordinate to Naylor's. Other makers of safety valves did practically the same thing. One of the principal infringers of the Richardson patent was sued and the lower courts decided that the English patent rendered the Richardson invention invalid.

The Consolidation Safety Valve Company, of which Charles A. Moore was president, had secured control of the Richardson patents and they appealed the case to the Supreme Court of the United States, where the decision of the lower court was reversed.

The opinion of the Supreme Court, as delivered by Justice Blatchford, has been a palladium to real inventors. I can give only brief extracts from the opinion. He says, speaking of the English patents adduced against Richardson's original patent:

"It may be generally said that there never were in their day and before the date of that patent, or of Richardson's invention, known or recognized as producing any such result as his apparatus of that patent produced. Likenesses to them in physical structure to the apparatus of Richardson in important particulars may be pointed out, but it is only as the anatomy of a corpse resembles that of the living being. The prior structures never effected the kind of result attained by Richardson's apparatus, because they lacked the thing which gave success. . . . Taught by Richardson and by the use of his apparatus, it is not difficult for skilled mechanics to take the prior structures and so arrange them as to produce more or less the beneficial results first made known by Richardson, but prior to 1866, though these old patents and their descriptions were accessible, no valve was made producing any results. . . .

"It appears to have been easy enough to make a safety valve which would relieve the boiler, but the problem was to make

one which, while it opened with increasing power of the steam against the increasing resistance of a spring, would close suddenly and not gradually by the pressure of the same spring against the steam. This was a problem of the reconciliation of antagonisms which so often occurs in mechanics, and without which practically successful results are not obtained. What was needed was a narrow stricture to hold back the escaping steam and secure its expansion force inside the lip and thus aid the direct pressure of the steam from the boiler in lifting the valve against the increasing tension of the spring, with the result that, after only a small but a sufficient reduction in the boiler pressure, the compressed spring would, by its very compression, obtain the mastery and close the valve quickly. This problem was solved by Richardson and never before.

“Richardson’s invention brought to success what prior inventors had essayed and partly accomplished. He used some things which had been used before, but he added just that which was necessary to make the whole a practically valuable and economical apparatus. The fact that the known valves were not used, and the speedy and extensive adoption of Richardson’s valve, are facts in harmony with the evidence that his valve contains just what the prior valves lacked, and go to support the conclusion at which we have arrived on the question of novelty. When the ideas necessary to success are made known, and a structure embodying these ideas is given to the world, it is easy for the skilled mechanic to vary the form by mechanism which is equivalent, and is, therefore, in a case of this kind, an infringement.”

### Feed Water Pumps.

From the first day that a locomotive was put to work it became necessary to provide some means of forcing water into the boiler while it held pressure of steam. Cases have been known where locomotive boilers have been filled through the safety valve opening, steam raised and the engine worked until the water was as low as it could safely be permitted to go when it was again replenished through the same aperture as before.

That was a sort of backwoods method and had few imitators. For many years it was the practice to provide all locomotives with force pumps. Those who have wrestled with loco-

motive pumps nearly all rejoiced to see them replaced by a more reliable boiler feeder. There were, in their day, full-stroke pumps and half-stroke pumps, pumps worked by cross-heads, pumps worked by eccentrics, but they were all troublesome to keep in good working order. A water pump was a locomotive attachment that gave illimitable scope to the imagination of the engineer, who made defects reports at the end of a trip. Men who could find nothing else to complain about would report pumps working badly, and no one could successfully contradict them. The trouble generally was in the pipes leading to the pumps, but that did not excuse the repair man from examining all the valves from tender to the boiler.

### **Injectors.**

The introduction of the injector was a great boon to everyone connected with the operating of locomotives. Although the injector is not theoretically so efficient as a good pump it has proved itself the best means ever tried for feeding water to locomotive boilers. When a well made injector is used regularly, it is more reliable than any form of pump, is more easily examined and repaired when it gets out of order, is less liable to freeze or to sustain damage from accidents, and it regulates the quantity of water required as well as any pump and better than any pump actuated by the machinery of a locomotive running at irregular speeds. The injector also possesses the important advantage as a boiler feeder that it raises the temperature of the feed water to approach the temperature of the boiler, thereby obviating the shocks and strains to the metal that cold water is likely to impart.

### **Invention of the Injector.**

The boiler feed injector was invented about 1852 by Henri Giffard, an eminent French scientist and aeronaut. Giffard was one of the first aeronauts to construct what he proposed would be a dirigible balloon, which was a spindle-shaped vessel 144 feet long. It was in connection with this balloon that he invented the injector that was intended to be part of a very light steam engine. The balloon did not meet with the expectations of the inventor and the injector was laid aside and almost forgotten. During a sea voyage, Giffard happened to meet Stewart, of the engineering company Sharp, Stewart & Co., Man-

chester, England. In the course of a conversation on boiler feeders, Giffard remembered his injector and described its method of action. Stewart was struck with the simplicity of the device and, as his company were locomotive builders, he concluded that the injector would make an admirable boiler feeder for locomotives. He undertook to introduce the injector in the British Isles and his company acted as general agents for its sale. By their advice William Sellers & Co., Philadelphia were given control of the American patents, and their wide connection with railroad companies served to introduce it under the most favorable auspices.

The Giffard injector was little more than a syringe or squirt that projected a stream of water with very little means of regulating the flow. The problems solved by the improvers of the injector was producing an instrument that could be regulated to feed with exactness the quantity of water required, also to raise the water from a lower level and to make the injector feed water of moderately high temperature. Another peculiarity of injectors that has received much attention from inventors is making the instrument automatic in restarting itself when for any reason the feed flow has been interrupted.

Williams Sellers & Co. have introduced several forms of injectors since they began making improvements on the Giffard. Their latest is known as Class P, shown on page 580. This injector is simply constructed and contains few operating parts. The lever is used for starting only and the water valve for regulation of the delivery. It is self-adjusting with fixed nozzle and restarts automatically. All the valve seats that may need refacing can be removed, the body is not subject to wear and will last a lifetime.

The action is as follows: Steam from the boiler is admitted to the lifting nozzle by drawing the starting lever (65) about one inch without withdrawing the plug on the end of the spindle (7) from the central part of the steam nozzle (3). Steam then passes through the small diagonal drilled holes and discharges by the outsize nozzle, through the upper part of the combining tube (2) and into the overflow chamber, lifts the overflow valve (30) and issues from the waste pipe (23). When water is lifted the starting lever (65) is drawn back, opening the forcing steam nozzle (3), and the full supply of steam discharges into the combining tube, forcing the water through the delivery tube into the boiler pipe.

At high steam pressure there is a tendency in all injectors having an overflow to produce a vacuum in the chamber (25). In the Improved Self-acting Injector this is utilized to draw an additional supply of water into the combining tube by opening the inlet valve (42); the water is forced by the jet into the boiler, increasing the capacity about 20 per cent.

The water-regulating valve (40) is used only to adjust the capacity to suit the needs of the boiler. The range is unusually large.

The cam lever (34) is turned toward the steam pipe to prevent the opening of the overflow valve when it is desired to

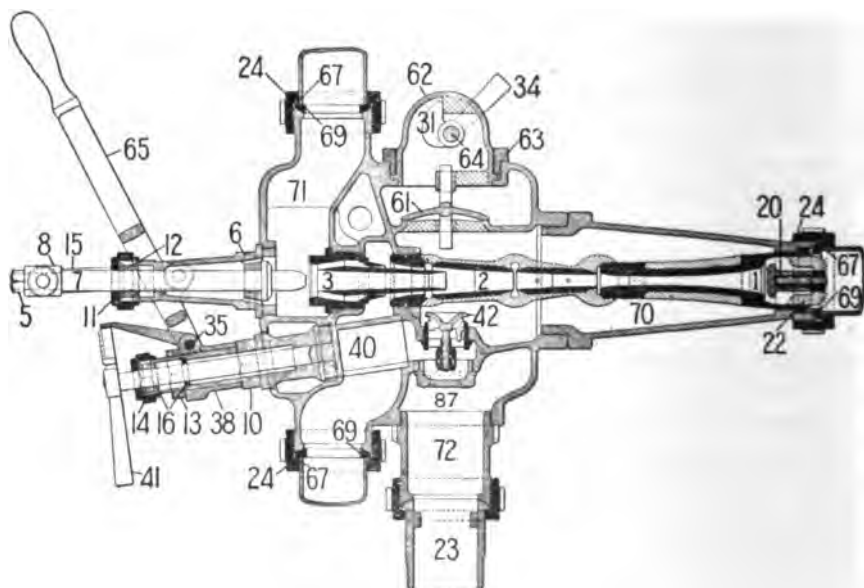

use the injector as a heater or to clean the strainer. The joint between the body (25) and the waste pipe (23) is not subject to other pressure than that due to the discharging steam and water during starting; the metal faces should be kept clean and the retaining nut (32) screwed up tight.

To tighten up the gland of the steam spindle, push in the starting lever (65) to end of stroke, remove the little nut (5) and draw back the lever (65). This frees the cross head (8) and links (15), which can be swung out of the way, and the follower (12) tightened on the packing to make the gland steam tight.

The Improved Self-acting Injector is specially adapted to



railroad service, as its efficient, positive action and wide range of capacities at 200 pounds steam render its application to high pressure locomotive boilers very advantageous. It will work from the highest steam pressures used on locomotives down to 35 pounds steam without adjustment and without wasting at the overflow, and by regulating the water supply valve on the injector it can be operated at 15 pounds. As it restarts instantly under all conditions of service, it can always be depended upon to force all the water required into the boiler, so that the engineer can give his whole attention to his other duties.

The injector is economical to repair. Comparative tests show the marked superiority of the improved form over all other styles of injectors, especially when the feed water is impregnated with lime. The tubes of all classes of the same size are interchangeable. All parts made to gauge and all openings of tubes guaranteed within  $\frac{4}{10,000}$  inch.

The Nathan Manufacturing Company have long been popular makers of injectors and have several forms on the market. Their latest and most approved is

#### **Nathan's Simplex Injector.**

This injector is designed to meet the severest requirements of modern high pressure locomotive service, especially where it is desired that the instrument be self-adjusting, and restarting. Its construction is such that the interior parts are readily accessible for inspection, repair and renewal, and as the steam valve does not seat on the body but on the steam nozzle, the latter forming a removable seat, the body is practically indestructible.

The injector is self-adjusting and does not require adjustment for variations of steam pressure. Should the pressure drop from 200 pounds down to 40 pounds the injector would continue feeding without loss of water from the overflow. It is also restarting, and if the water supply should happen to be temporarily interrupted, the instrument will start feeding again without any manipulation, just as soon as the water supply is again in reach. Owing to the wide range of the injector it can be kept feeding continuously at all pressures. The capacity increases with increased pressures at moderate feed-water temperature.

A peculiar feature of the injector is the inlet valve 19, which not only admits an auxiliary supply of water into the overflow chamber, which water, drawn in through the openings of the

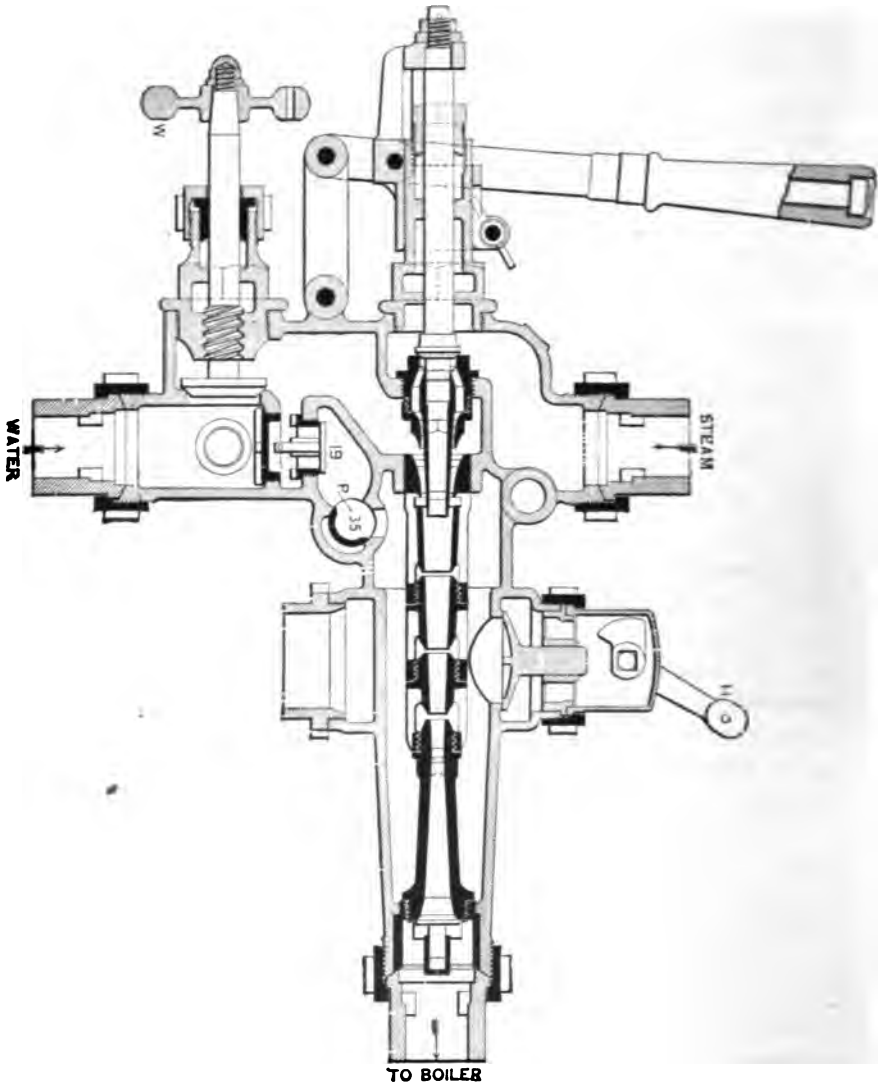

Nathan's Simplex

nozzles, increases the capacity, but its cooling effect prevents incrustation of the nozzles and reduces the cost of maintenance.

If it is desired that the injector be placed outside of the engine cab and operated by means of extension rods, a quick motion screw attachment can be readily substituted in the place of the lever handle.

An injector that forced its way into the favor of railroad mechanics by sheer merit is the

### Little Giant Locomotive Injector.

This injector is made by the Rue Manufacturing Company,

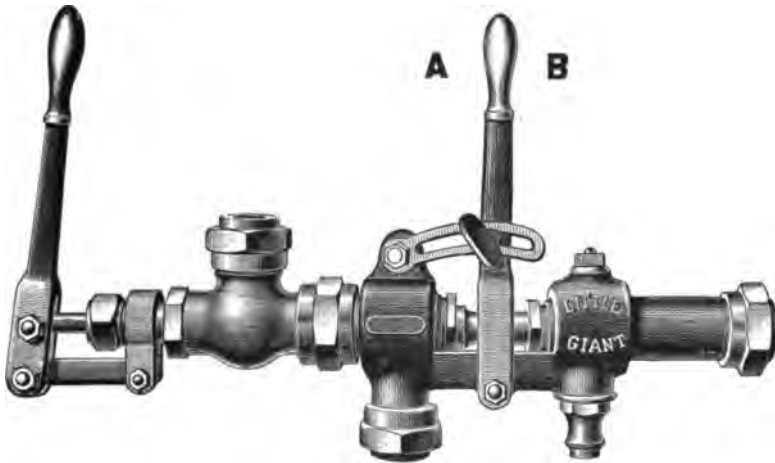

Little Giant. Rue Manufacturing. Company

of Philadelphia, and has been upon the market for the last thirty-five years, and is still a favorite on many railways, especially by the men who operate injectors or keep them in working order. They are not handicapped by "interior valves," are simple in construction and operation, therefore not liable to get out of order. If tubes corrode or wear from bad water they are easily replaced. They are fitted with a movable combining tube, operated by a lever which allows them to be adjusted to work correctly at different pressures of steam and conditions.

# Locomotive Works Still in Business

## CHAPTER XXXI.

"Many are called but few are chosen" has been the lot of the people who have embarked their fortunes in the business of locomotive building in the United States.

The most celebrated of those establishments which have passed



John H. Converse, General Business Manager  
Baldwin Locomotive Works

through all the vicissitudes and storms of commercial disasters, the Baldwin Locomotive Works is the oldest, a beginning having been made in 1831. I have already related so many particulars of the work done at Baldwin's that the story of their progress is familiar to the readers of these pages. It will suffice to say that the firm has always kept in the van of advanced methods and forms and that the production of the

Baldwin Locomotive Works up to the present date, represents the whole history of locomotive building in this country.

Of the remaining establishments engaged in the work of locomotive building, the Rogers Locomotive Works come next to Baldwins in respect of years, having begun work in 1837. Particulars concerning the forms of locomotives built by Rogers, when the works were taking a leading part in developing the locomotive, have already been told. Age did not bring decrepitude, for the works are turning out to-day locomotives of the most advanced designs, made by the most improved machines and methods. The American Locomotive Company are now owners of the principal stock of the Rogers Locomotive Works.

### John Homan Converse.

John Homan Converse, whose portrait is shown, is an important figure in the locomotive building world, being general business and financial manager of the Baldwin Locomotive Works. Mr. Converse, like many other successful business men, was born in Vermont, a state "stern and wild" like Scotland, and, like that country, more noted for the production of men than of riches.

Mr. Converse enjoyed the benefits of a university education, graduating in 1861. His first work, that of reporter and editor of a country paper, was another education, but it served principally to make him ambitious for wider fields than Burlington, Vt., afforded. That was in 1864, when ambitious young men were taking Greeley's advice to "go west," so Mr. Converse moved to Chicago. There he was in the employ of the Chicago & Northwestern Railway until 1866, when he went with Dr. Edward H. Williams to Altoona, where the latter had taken charge, as general superintendent, of the Pennsylvania Railroad. Four years later Dr. Williams became a partner in the Baldwin Locomotive Works, and recognizing the excellent business capacity of Mr. Converse induced him to enter the same employment. It speaks well for the good judgment of Dr. Williams in choosing assistants, that three years after entering the Baldwin Locomotive Works Mr. Converse became a partner.

Under the financial management of Mr. Converse the Baldwin Locomotive Works have prospered and expanded into wonderful dimensions, being now the largest establishment of the kind in the world. In spite of the onerous duties of the

position Mr. Converse finds time to devote considerable attention to civic affairs and is a member of various committees working for the public good of Philadelphia.

### **American Locomotive Company.**

The American Locomotive Company was incorporated under the laws of the State of New York, June 10, 1901.

The leading officers elected and those who carried on actively the business of the company were Samuel R. Callaway, president; Albert J. Pitkin, vice-president; Leigh Best, secretary, and Charles B. Denny, treasurer.



Samuel R. Callaway

According to the first annual report of the American Locomotive Company, the following properties were acquired by purchase:

- The Schenectady Locomotive Works, Schenectady, N. Y.
- Brooks Locomotive Works, Dunkirk, N. Y.
- Pittsburgh Locomotive and Car Works, Alleghany, Pa.
- Richmond Locomotive Works, Richmond, Va.
- Cooke Locomotive and Machine Works, Paterson, N. J.
- Rhode Island Locomotive Work, Providence, R. I.

Dickson Locomotive Works, Scranton, Pa.

Manchester Locomotive Works, Manchester, N. H.

President Callaway reported that the advantages of consolidation had been fully sustained by the results of the first years' operations. Among the benefits accruing to the owners of the property have been:

Greatly improved facilities through the infusion of new capital, thereby reducing the direct as well as the indirect labor cost.

The utilization of shop space at the different plants to the best possible advantage, thereby enabling the company to take orders for future delivery with better assurance of their prompt fulfillment.

A minute, constant comparison of manufacturing processes, and the gradual unification of shop methods through the interchange of ideas.

Some steps, at least, toward the standardization of locomotive design.

The reduction of cost through purchasing in large quantities.

A more intricate knowledge of the detailed cost of engine construction, through the adoption of a carefully classified uniform system of accounting.

### **President Callaway.**

The public history of the company is that President Samuel R. Callaway died in June, 1904, and was succeeded by Albert J. Pitkin, who was previously vice-president. Mr. Callaway was born at Toronto, Canada, in 1850, and entered railway service when thirteen years old. He rose by various grades through great native ability until he reached the position of President of the New York Central Railroad. He gave up that position to be president of the American Locomotive Company.

### **President Pitkin.**

President Pitkin lived little more than one year in the enjoyment of the commanding position he had reached. Albert J. Pitkin was born in Ohio in 1854 and passed through the experience of machinists apprenticeship in a shop in Akron. It was probably his leaning toward locomotives that led Mr. Pitkin to choose a mechanical career, for he told me that when

a boy the sight of trains passing his home inspired him with the ambition to be an engineer, a thing that has happened to many a country boy. The fancy to be a locomotive engineer faded with years, but its influence probably led him to the Baldwin Locomotive Works when he started out as a journeyman machinist. He worked in Baldwins for several years, part of the time in the machine shops and more time in the drawing office. Then he went to the Rhode Island Locomotive Works as chief draftsman, a position he left a few years later to become mechanical engineer of the Schenectady Locomotive Works, rising there to be general manager. His position with the Schenectady Locomotive Works commended Mr. Pitkin to the vice-presidency of the American Locomotive Company when it was formed.

With a quiet subdued manner Albert J. Pitkin was a man of tremendous push and energy, which no doubt helped to put the American Locomotive Company upon the prosperous career it is now enjoying.

#### **Cooke Locomotive and Machine Works.**

Is the oldest of the locomotive building works belonging to the American Locomotive Company. A synopsis of the origin of the Cooke Locomotive and Machine Works is given beginning on page 247, but I am pleased to add further particulars concerning

#### **John Cooke,**

the honored founder of the extensive works now bearing his name, was born in Montreal, Canada, in 1824. His parents removed first to Albany, N. Y., and later, when the subject of this sketch was still very young, to Matteawan, N. Y.

When he had reached the age of fifteen, the family removed to Paterson, N. J., which was destined to be the scene of his active and useful lifework. He entered the works of Rogers, Ketcham & Grosvenor as an apprentice, and soon developed such remarkable ability that, some four years later, when he had scarcely attained his majority, he was placed at the head of the establishment as superintendent, which position he retained until July, 1852, when he associated himself with Charles Danforth, John Edwards and Edwin T. Prall in forming the firm of Danforth, Cooke & Co.

Mr. Cooke was most properly regarded as the founder, par



excellence, of the industry, owing to the undisputed fact that he was the chief factor in the business of locomotive building, of which he alone possessed the knowledge requisite to success. He was at the time almost indispensable to the firm of Rogers, Ketcham & Grosvenor, where he was the head and front of locomotive construction, and was receiving what in that day was looked upon as a princely salary, and, just before leaving, was offered a partnership. But he was already committed to his future associates and, therefore, declined.

Personally, John Cooke was of studious habits, being especially attracted towards mathematics and history. He was also a man of untiring industry, was possessed of great dignity and force of character; one that was destined to make his mark in his day and generation. From the position of a poor boy, he worked his way steadily upward, until he attained a place in the front rank among American mechanics. He is conceded to have contributed greatly toward perfecting and giving character to the engines turned out by Rogers, Ketcham & Grosvenor, and his great ability and remarkable business talent being transferred to the firm of Danforth, Cooke & Co., the productions of that concern, and of its successor, the present company, also bore his impress, as to character and excellence, even to the latest locomotive engine completed at the works up to the time of his death, which occurred February 20th, 1882, at the age of fifty-eight.

### President Marshall.

Waldo H. Marshall succeeded A. J. Pitkin as president of the American Locomotive Company. Mr. Marshall began his engineering career as apprentice in the Rhode Island Locomotive Works. He went West shortly after completing his apprenticeship and went through a wide and varied experience. His first venture was into the field of railroad journalism in Chicago and New York. He left the editor's chair in 1897 and entered the mechanical department of the Chicago & Northwestern Railway as assistant superintendent of motive power. Two years later he went to the Lake Shore & Michigan Southern Railway as superintendent of motive power. The higher officials of that company seemed quickly to perceive Mr. Marshall's ability, for, having proved a decided success as a superintendent of motive power, he was quickly advanced

to the position of general superintendent, and a few years later to be general manager. He was induced to relinquish that high position for the head of the American Locomotive Company.

While on the Lake Shore & Michigan Southern Railway Mr. Marshall made his mark as a locomotive designer. His 2-6-2 heavy express passenger engine is reported to be as fine a type of locomotive as ever ran on rails. The indications are that Mr. Marshall will prove as great a success in managing the American Locomotive Company as he has been in the other positions he has filled.



Waldo H. Marshall

### **The Schenectady Locomotive Works.**

The Schenectady Locomotive Works was a corporation formed under the laws of the State of New York, chartered for the purpose of Manufacturing Locomotives, and General Manufacturing in the line of engines, etc.

The original company, which was known as the Schenectady Locomotive Engine Manufactory, was formed in January, 1848, the capital for the building being raised by the citizens of Schenectady, and the necessary capital for the equipment with machinery was raised by a company headed by the Norris Locomotive Works, of Philadelphia, Pa., which agreed to pay the interest

on the capital annually, and to pay the stockholders the whole capital in eight years, and thus themselves become the owners of the property. This company carried on the works for about one year, and then failed.

The only record of the Norris proprietorship of the Schenectady Locomotive Works is the picture of a Crampton locomotive shown on page 97, which was built for the Syracuse and Utica Railroad. This was a striking example of courting failure. The "Lightning," as the engine was called, was essentially a high speed machine built for a pioneer railroad better adapted to animal power than to a locomotive with a single pair of drivers seven feet in diameter.

When the Norris Company permitted the locomotive works

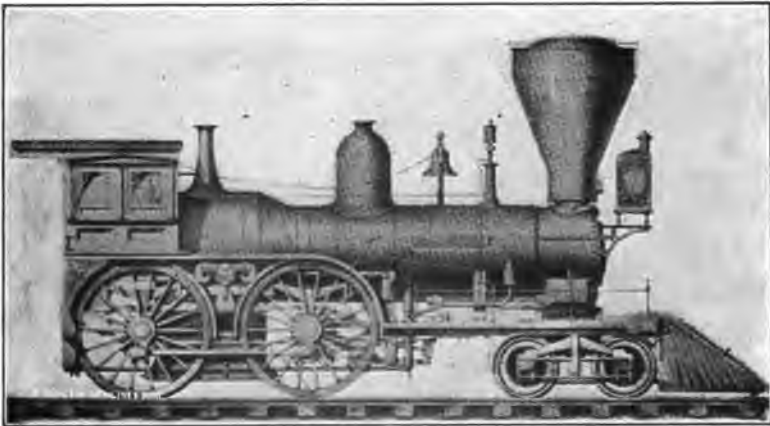

Fig. 257. Anglo-American McQueen (Schenectady), 1856

to be closed, they stood idle for about a year, after which the whole property was sold to John Ellis, Daniel D. Campbell and Simon C. Groot, who, with others, raised new capital and in 1851 the Schenectady Locomotive Works Company was organized.

### Walter McQueen.

Walter McQueen, a level-headed Scotsman, who had been a railroad master mechanic for a short time, was chosen superintendent. Mr. McQueen remained only a short time at railroad work when he quit and opened a machine shop at Albany, N. Y., where, among other work, he built a few small locomotives. That was good training and was of much service to Mr. McQueen as

superintendent of locomotive works striving to obtain a foothold in a manufacturing business already crowded with competitors.

Under Mr. McQueen's management, the Schenectady Locomotive Works began by building small locomotives weighing about 12 tons, a single pair of drivers in front of the fire box, much the same pattern as the Norris Works, of Philadelphia, prior to the time the Schenectady Locomotive Works began business. The light form of engine was soon abandoned for the 8-wheel American type, and with that form of locomotive the works acquired a high reputation, the so-called "McQueen" engines having attained great popularity, especially on western railroads.

The business of these works grew prosperous steadily, until they were the second largest in the country. During the decade 1851 to 1861, they built annually 20.8 locomotives, increasing each de-



Fig. 258 Standard McQueen Engine

cade to 44.6, 64.9, 200., and during the last decade of its independent existence, the output averaged 190 a year.

When the Schenectady Locomotive Works first increased the weight of their engines to about twenty tons, they built some inside connected engines, of the type shown in Fig. 257, which seemed to be a compromise between New England styles and those of Philadelphia and Paterson. That fashion of engine did not prove a favorite, especially in the west, and McQueen worked steadily towards the type shown in Fig. 258, which continued to be the standard of the works for many years.

#### Work of A. J. Pitkin.

Under Mr. McQueen's control, the influence of the management was exerted in favor of fairly light eight-wheel American engines. In 1882 Mr. A. J. Pitkin became mechanical engineer of

the Schenectady Locomotive Works, and his influence was exerted in favor of heavier locomotives, especially for increasing the size, of boiler and grate area. In conjunction with William Buchanan, superintendent of motive power of the New York Central Railroad, in 1891 Mr. Pitkin designed a type of 4-4-0, which was the heaviest of the kind ever built, and led the movement towards abnormally heavy fast locomotives. The first engine of the kind is illustrated on page 162. The engine had cylinders 19 x 24 inches, driving wheels 78 inches diameter. There were 1821.5 square feet of heating surface, and 27.3 square feet of grate area. The total weight of the



Albert J. Pitkin

engine in working order was 120,000 pounds, of which 80,000 were on the driving wheels, being 10,000 pounds per wheel. Traction force per pound M. E. P. was 111.07. In test made with an engine of this class pulling the Empire State Express, 52 pounds M. E. P. were recorded when running 60 miles an hour.

The trend of the works after 1890 was to build heavier engines for every service where increased power and weight improved the efficiency. In 1890 the works built their first compound locomotive of the two cylinder kind, the intercepting valve having been designed and patented by A. J. Pitkin. These compounds have gained many friends.

At the time the Schenectady Locomotive Works were absorbed by the American Locomotive Company, the officers of the Company were: William D. Ellis, President and Treasurer; Albert J. Pitkin, Vice-President and General Manager, and James E. Sague, Mechanical Engineer.

### The Brooks Locomotive Works.

The Brooks Locomotive Works owe their origin to the Erie Railroad. When the New York and Erie Railroad was projected, Dunkirk, on Lake Erie, was made the western terminus, and it was expected that a large lake maritime city would arise through



Brooks Locomotive Works in 1869

the business carried to that point by the railroad, but the expected mart of commerce grew very slowly, for the tendency of trade was to desert the Erie Railroad at western points and go to Buffalo. Recognizing the inevitable, in 1863 the management of the Erie leased for 499 years the Buffalo, New York and Erie Railroad, extending from Corning to Buffalo, which provided the Erie direct connection with the city that was attracting a large share of west bound traffic.

When Jay Gould became president of the Erie in 1868, he adopted the policy of diverting the principal share of the company's business to Buffalo, and on that account Dunkirk became little more than a way station. The principal part of the loco-

motives formerly housed there were moved to other places and the large engine houses built for a great terminal station were offered for sale. Horatio G. Brooks, then superintendent of the Erie, obtained possession of the shops in 1869, and converted them into locomotive building works.

With Mr. Brooks was associated Marshall L. Hinman as treasurer and financial manager.

The following extracts from an address delivered by Mr. Hinman at a farewell banquet given to Harry C. Hequembourg on the occasion of his leaving Dunkirk, illustrate in an eloquent manner the struggles of the Brooks Locomotive Works in the early years of their existence.

### History of Brooks Locomotive Works.

"I have only to refer to the records of the locomotives completed at the Brooks Locomotive Works in its early history, to indicate the condition of the manufacturing business. The Brooks Locomotive Works were organized and commenced operations November 1, 1869. During the first month of our corporate existence we completed one locomotive, one also is the total number recorded in December. In January, 1870, we were able to complete two, in February one, and the total output of the first year of our corporate existence was twenty-seven. During the calendar year ending December 31, 1871, we had completed 45 locomotives, and for the year ending December, 1872, 73, which brought the average up to six locomotives per month, and a like condition existed until September of the following year, the time of the great financial panic heretofore mentioned. During the entire year of 1874 but six locomotives were completed, two in February, one in May, one in August, one in October and one in December, and during the first ten months of 1875 the total output of the works was only ten locomotives; but the Centennial year having dawned upon the country, stimulated all industries, and set the wheels of commerce rolling. Our output was increased during the calendar year to 47, but the stimulus of the Centennial having exhausted itself, depression followed, so that during the first nine months of 1877 we completed but six engines, and only 17 during the entire year. In 1878, 32 locomotives represented the total number finished, and this condition continued until the Fall of 1879, when there were marked signs of permanent re-

covery from the late depression, so that during that year 44 engines marked the record. The early winter months of that year Mr. Brooks, with part of his family, if not all of them, were upon the Pacific coast, and I was looking after what little business was offered; and to illustrate how anxious we were to obtain locomotive contracts—in order to keep our men employed—we were taking them at the bare cost for labor and material, and during October or November, 1879, we received an inquiry from the Erie Railway for 15 passenger engines. Careful estimates were



Marshall L. Hinman

made upon the actual cost of these engines for labor and material. I went to New York and after several days' conference with the officials of the road—at which time I bid upon the construction of these engines at cost price—we were awarded the contract. While there was no profit in it for the proprietors of the works, we had the satisfaction of knowing that we would be able to give employment to quite a large number of men during the winter months, and it was a source of great gratification on this account to Mr. Brooks, when advised of the contract. Per-



haps it would not be out of character to state at this time that the total profit upon such 15 locomotives was barely above cost, as our books will show at the present time.

"Mr. Brooks returned from the Pacific coast early in 1880, and so impressed was he with the situation and the prospects of the return of active business, after so long a depression, that he immediately commenced the construction of new buildings, the purchase of late and improved machinery to meet the demand for new equipment, and the wisdom of such a course was fully demonstrated before the end of twelve months, as the whole country was blessed with great business activity, so that during the year ending December 31, 1880, we had completed 100 locomotives. During 1881, we had increased our output to 146, and in 1882 we showed a total of 203, during the month of October of which year we had turned out 20 engines. Such continued activity in the country could not last forever, and our records show that the volume of our business commenced diminishing in about July of that year, as only 46 locomotives were turned out during the last six months of 1883.

"As depression always follows a term of great activity, such condition was upon us during the three years following, as can better be shown by the fact, that during the year 1884 we turned out 73 engines, in 1885—27, and in 1886—87. Activity resumed somewhat during the latter month of that year and conditions continued favorable until 1893, when the country was again visited by a financial disturbance, but not to such an extent as the one of 1873. However, it so affected our business that the aggregate number of engines constructed during 1894 was 90. One hundred and ninety-five were completed in the following year and 100 during the year of 1896, from which time until the present business has continued to increase, so that during last year 317 locomotives were completed at the Brooks Works. I have here given the mechanical growth of the works during the period of 30 years, and will now state some other facts connected with the Brooks Locomotive Works.

"At the time the company was incorporated in November, 1869, Mr. Brooks was elected president and superintendent, and I was elected secretary and treasurer.

"In June, 1885, Mr. Brooks resigned the office of superintendent and Mr. J. H. Setchel was elected to the position, which office he continued until August 1st, 1888.

“Mr. Brooks continued as president of the works until his death, which occurred April 20th, 1887, and as noble and honorable a man as ever lived. He was succeeded as president by his son-in-law, Mr. Edward Nichols, who died of pneumonia on January 7th, 1892, after a brief illness, having been president of the works about five years. At the time Mr. Nichols was elected president in June, 1887, a new office of vice-president was created, and I was elected to fill the same, continuing also the duties of treasurer, and upon my election to the position of president, February 13th, 1892, I resigned the office of vice-president and Mr. R. J. Gross was elected to that position.



David Russell

“At the time of my election to the position of vice-president of the works, June 9th, 1887, Mr. Theodore M. Hequembourg was elected secretary, which office he continues to hold at the present time.

“I continued in the office of president until December, 1896, when I was succeeded by Mr. Frederick H. Stevens, the present incumbent of the office of president.

“Mr. Robert J. Gross, Second Vice-President of the American Locomotive Company, entered the employ of the Brooks Locomotive Works in March, 1882, Mr. Brooks having appointed him

traveling agent, subsequently agent, and he was elected vice-president February 13, 1892.

"Mr. David Russell should not by any means be omitted in the history of the Brooks Works. At the time of its organization in 1869 he was a foreman, and continued in that capacity for several years, being promoted for meritorious service on January 1st, 1877, to assistant superintendent; later, February 1st, 1890, to superintendent, and on July 1st, 1898, to general superintendent, and a due amount of credit should be given to this worthy man for his zeal in behalf of the great industry which he so ably assisted in establishing in this city.

"The business of the works having increased to such an extent, the employment of an additional superintendent was necessary and we were fortunate in securing the services of the present incumbent, Mr. James McNaughton, who entered the service of the Brooks Works July 1st, 1898, and the able manner in which the mechanical department has been managed during the past few years, demonstrates the wisdom of his selection."

#### **James H. Setchel.**

Among those mentioned by Mr. Hinman as having been superintendent of the Brooks Locomotive Works was J. H. Setchel, whose career as a railroad man deserves more extended notice. Mr. Setchel was born in New York State 71 years ago and has spent the whole of his life on railroad mechanical employment or in railroad supply business. He learned the machinist trade in the Detroit Novelty and Machine Works, then went to work on the Ohio and Mississippi Railroad under Horatio G. Brooks. The friendship formed at that time led to Mr. Setchel being appointed superintendent of the Brooks Locomotive Works many years later.

Through various steps Mr. Setchel rose to be a master mechanic on one of the western lines of the Pennsylvania Railroad. While there he joined the American Railway Master Mechanics' Association in 1869, at its second convention. Two years later he was appointed secretary of the association and continued in the position eighteen years. The railroad companies and the individuals who have benefited from the work done by the American Railway Master Mechanics' Association have to thank Mr. Setchel for carrying it over many a weak spot. But for his self-sacrificing efforts there would be no such association to-day.

### Rhode Island Locomotive Works.

During the Civil War the establishment which afterwards became the Rhode Island Locomotive Works was known as the Burnside Rifle Company. When the war closed and the need for weapons of destruction ceased, the proprietors of the Burnside Rifle Company decided to convert the place into locomotive building works.

A company was formed with General Burnside, president, and Earl P. Mason, treasurer, John G. Pusey, superintendent, George



James H. Setchel

H. Rutter, assistant superintendent, and Edward A. Page, chief draughtsman.

Rutter had been with M. W. Baldwin for twenty-five years, and he naturally imitated the Baldwin designs, although Mr. Page was the real designer. He had served his apprenticeship with Richard Norris & Son.

The first engine built in these works was a sort of modified Baldwin, using the cylinder and half saddle in one casting, while

the frame and wheels were similar to those used by Mason. The first engine was finished in 1866 and was called "Governor Burnside." It was bought by the Providence and Worcester Railroad, and weighed about 29 tons. The cylinders were 16 x 22 inches and driving wheels 5 feet diameter. Their second engine, of dimensions similar to the first, also went to the Providence and Worcester Railroad, and was called the Wm. D. Hilton.

There was considerable prejudice in New England against the half-saddle cylinder and Mr. Pusey had a full set of patterns made for cylinders of the Mason form.

Orders were received for engines for different southern roads which brought a good reputation, for they were built in first-class shape of excellent material. They gradually worked into a good business and had no difficulty in disposing of all the locomotives they could build.

Mr. Pusey continued to build engines of different types until about January 1st, 1868, when he resigned the superintendency and was succeeded by Benj. W. Healey, from McKay and Aldus' shop, in East Boston. Mr. Healey made a number of changes, nearly all in the line of having his engines look and be like those built by Wm. Mason, and he was a very fair copyist. The works continued under his management until 1875; by that time he had done considerable in the way of getting away from his "first love," i. e., a Mason engine. D. A. Wightman, who afterwards made a high reputation as superintendent of the Pittsburgh Locomotive Works, was acting superintendent of the works from the time of Mr. Healey's departure until the summer of 1876, when John A. Durgin was made superintendent, staying there several years.

Joseph Lythgoe succeeded Mr. Durgin as superintendent, and remained in the position until within a few years. Besides turning out good engines of various types, Mr. Lythgoe gained some renown by building the Johnstone double-end compound locomotive for the Mexican Central Railroad, which is illustrated in the chapter on "Freaks and Curiosities in Locomotive Design." He also distinguished himself in connection with a group of compound locomotives built by the Rhode Island Locomotive Works for the Brooklyn Elevated Railroads.

### Pittsburgh Locomotive and Car Works.

Having learned that Andrew Carnegie had something to do with the Pittsburgh Locomotive and Car Works in the early

days of their history, I inquired of Mr. Carnegie and received the following letter:

"My Dear Mr. Sinclair:

"I organized the Pittsburg Locomotive Works with my friend Thomas N. Miller and others, in 1865. The capital, \$200,000, of which I took the then enormous sum of \$20,000; Miller one-half of that sum. Mr. Miller tells me that the shares of \$100 now sell from \$2,900 to \$3,000.

"Miller was pioneer in iron business, interested Phipps by lending him \$800 to buy stock with. My brother and I followed soon after that."

From D. A. Wightman, who was long engineer and manager of the Pittsburgh Locomotive and Car Works, and whose splendid management did much to bring the works to their high state of efficiency as a manufacturing concern, I have received further particulars. Mr. Wightman writes: "The Pittsburgh Locomotive and Car Works were organized in 1865. The plant was intended to build cars as well as locomotives, but none of the former were ever built or any steps taken to instal tools for other than locomotive construction. D. A. Stewart was the first president, Andrew Carnegie and, I think, Thomas A. Scott were among the early stockholders. Upon Mr. Stewart's death, Wilson Miller, for many years secretary and treasurer, became president and held the office until the plant was transferred to the American Locomotive Company.

"Thatcher Perkins, of Baltimore and Ohio Railroad fame, was the first superintendent. He was succeeded by J. A. Durgin about 1869, who remained there until I went to take charge in 1876. J. Snowden Bell was first draftsman and the first locomotive was turned out in 1867."

About 1884 Mr. Wightman inaugurated an arrangement of shop tools that greatly lessened the cost of production and was adopted later by all other locomotive builders and by most railroad companies. It had been the practice to group certain tools together such as lathe planers, boring mills, shapers, and work had frequently to traverse the shop several times to reach the tools whose operation were needed. Mr. Wightman arranged the tools to suit the successive operations, so that a piece of work on entering the machine shop was moved steadily along until it reached the erecting shop. Tools that worked on heavy pieces, such as cylinders, were so located that a crane or car carrying the work could reach them. Another policy followed was to use

the most powerful tools on the market for doing particular work and to hold them up to their maximum duty.

Great attention was bestowed upon the arranging of an iron foundry that would be a model of its kind. The aim was carried out right enough and these works were noted for turning out splendid castings at an abnormally low cost.

The works gradually worked up to an output of about 100 locomotives a year. After Mr. Wightman had a fine new foundry and other buildings erected, the capacity of the works went to about 150 locomotives a year, most of them heavy engines.



Andrew Carnegie

### **The Richmond Locomotive Works.**

The beginning of these works was a general machine business, begun in 1865 by Messrs. W. E. Tanner, J. O. Ebbitts and Alexander Delaney, and was for the manufacture of steam engines, boilers and milling machinery. Their work was successful, and the business was developed into the Metropolitan Iron Works.

A disastrous fire in November, 1881, caused the business to be removed from the corner of Canal and Seventh streets, Rich-

mond, to a tract of about 14 acres of land on the suburbs of Richmond, and a new charter was gotten for continuing the work under the name of The Tanner & Delaney Engine Company. Extensive buildings and machinery were constructed under the supervision of Mr. Alexander Delaney in 1882 and 1883.

In 1885 Mr. William R. Trigg succeeded Mr. Wm. E. Tanner as president of the company, and in 1886 the concern was developed into locomotive works, and was incorporated as The Richmond Locomotive and Machine Works. In 1889 the works secured the contract for the building of the machinery of the battleship Texas, which work was most successfully done. During the building of this machinery one of the engineers employed on it, Mr. C. J. Mellin, invented a compound locomotive, which was known afterwards as the "Richmond Compound," and was successfully operated. Mr. Wm. R. Trigg continued as president of the company, and developed it very greatly until 1898, when he resigned in order to take charge of the William R. Trigg Shipbuilding Company.

In 1890 Mr. E. T. C. Davis was elected general manager of the company, and introduced a great many improvements in the system of the works and inaugurated piece-work. Mr. Davis remained with the company five years, and was of the greatest possible service to it. In the fall of 1898 Mr. Joseph Bryan succeeded Mr. Trigg as president of the company and made still further additions to the plant. In June, 1901, the works were sold to the American Locomotive Company, and are now being operated by that company. The buildings and machinery now cover an area of about 26 acres of ground, and its appointments are in every respect of the best kind. In addition to its output of engines, which is about 320 a year, the plant is now manufacturing the Robinson steam shovel. The number of men employed is about 2,500.

The Richmond Locomotive Works had worked into a good business of building locomotives, but financially it held a very depressed position until 1898, when Mr. H. A. Gillis, newly appointed general superintendent, began reorganizing the works and putting them upon a sound manufacturing basis. Before his advent the use of labor saving appliances had found very little application, the cheap negro labor having been considered equal to any operation where brute strength, and the operation of nearly



a whole shop was sometimes suspended while a swarm of colored laborers were moving heavy parts that a crane would have carried to its place in a few minutes. That condition of misdirected energy was gradually changed by Mr. Gillis, who introduced labor saving appliances into all the shops and rearranged the tools so that machine operations could be carried on systematically.

Very free and easy practices prevailed among the personnel of the works, men in responsible positions carrying convivial practices inside the gates, while the same people felt at liberty to go outside to enjoy liquid refreshments during working hours. Any person who has had to wrestle with abuses of that character will readily understand the magnitude of the task undertaken by Mr. Gillis when he proceeded to clean this Augean stable. The work was done, however, and the company profited by the change to such an extent that in 1901 the property was sold to the American Locomotive Company for \$1,800,000 cash and \$1,200,000 in preferred stock.

The appreciation in which Mr. Gillis was held by the officials of the Richmond Locomotive Works was manifested by the presentation of a loving cup and a most complimentary letter signed by President Joseph Bryan, the principal part reading:

"In addition to all that this testimonial imports, I wish to add a word which could not be engraved on the silver. You know the difficulties which surrounded you when you first came to the Richmond Locomotive Works in September, 1897. You also know the vast improvement of its mechanical departments and the efficiency of its organization which, during your superintendency, it had gained when it passed into the hands of the American Locomotive Company in June, 1901. How much of this striking and acknowledged improvement was due to your own wisdom and energy I cannot fully express herein. I will say, however, that I do not know another man who, better than you, could have filled the place which fell to your lot. The work which you and your associates did made possible an achieved success which was obstructed by difficulties apparently insurmountable."

**Reuben Wells.**

Among the railroad mechanics who began work about the middle of the 19th century and continued putting their personality upon locomotives of the 20th century, Reuben

Wells, for the last twenty years superintendent of the Rogers Locomotive Works, has been very prominent.

The railroad engineering career of Mr. Wells began in 1849 when he entered the shops of the Philadelphia and Reading Railroad as an apprentice. He served first under Lewis Kirk and afterwards under James Millholland, taking part as a workman in the development of the locomotive worked out by these two pioneer improvers.

In 1852 Mr. Wells went to Shelbyville, Ind., and was appointed master mechanic of three small railroads that were



Reuben Wells, Long Superintendent Rogers Locomotive Works

afterwards absorbed by the Jeffersonville and Indianapolis Railroad. He followed the fortunes of that company for twenty-five years, until he left in 1878 to fill the position of superintendent of machinery of the Louisville & Nashville Railroad.

During the Civil War the railroads in Southern Indiana were loaded with burdens and responsibilities unknown to ordinary experience. In the summer of 1863 the fortunes of war made it necessary for the railroad on which Mr. Wells was master mechanic to transport the 11th and 12th army corps

from the Army of the Potomac to Nashville, Tenn., in the shortest possible time and with the least public notice. An officer from the War Department came to take possession of the railroads, and the work was done with extraordinary expedition, but Mr. Wells directed the whole of the train movement, having acted as superintendent, master mechanic, yardmaster and train dispatcher for eight days.

In June, 1868, Mr. Wells took part, with five other master mechanics, in organizing, at Cleveland, O., the American Railways Master Mechanics Association. He is the sole survivor of that small group. Mr. Wells was president of the



Special Grade-Climbing Locomotive, Designed and Built by Reuben Wells

association from 1882 to 1884, and was for years one of the most active members in committees and in discussions.

As already mentioned, Mr. Wells became superintendent of machinery of the Louisville and Nashville Railroad in 1878. About that time six other railroads were added to the Louisville and Nashville system, extending it from Cincinnati to New Orleans. The newcomers were roads that had struggled along with worn-out machinery. When an inventory of locomotives and cars was taken it was found to constitute the most extraordinary variety of patterns ever put under one ownership.

Eight years of strenuous work was devoted to bringing order out of chaos with eminent success. Then in 1884, the general manager having resigned, Mr. Wells reluctantly consented to take his place and served about one year. After that he acted for two years as assistant to the president. While he held that position it was decided to change the 1,500 miles of 5-foot gauge of the system to the standard. To Mr. Wells was assigned the duty of working out the details of making the change down to the minutest detail. The whole of this stupendous change was affected in one day without accident, mishap or delay. Mr. Wells naturally looks upon that event as one of the greatest achievements of his railroad career.

He became superintendent of the Rogers Locomotive Works and remained there till April, 1907. While there he carried out changes and improvements on the shops that practically doubled their capacity.

While living in Indiana Mr. Wells was for about five years one of the trustees of Purdue University. In the Railway Museum of that institution there is a locomotive named "Reuben Wells," which has an interesting history. On the Madison and Indianapolis Railroad there was an incline plane of 320 feet to the mile which was operated on the rack rail and cog wheel system. The question arose, was it practicable to operate that grade with smooth wheel locomotives? Mr. Wells undertook to build an engine that would do the work, and in 1868 turned it out of the railroad shops. It worked satisfactorily and continued operating for 19 years, after which it was assigned to lighter service. Three years ago it was placed in the museum mentioned, where it will stand for many generations to come, giving information concerning the early development of powerful locomotives.

# Railway Development in Canada

BY GEORGE SHERWOOD HODGINS.

## CHAPTER XXXII.

Canada as a country has been variously described. It has been spoken of as being bounded on the east and west by the two great oceans, on the south by the 49th parallel and the

great lakes, and in the other direction by the North Pole. Being an integral part of the British Empire the development of its railway system practically began in the importation of men and of rolling stock from the mother country. As railroad enterprises took shape the system has grown side by side with that of the great republic, and Canada's railway system, is essentially American in the broad continental sense of that word. The various railway associations and societies in the United States which have done such splendid work in the mat-



George S. Hodgins

ter of unifying and standardizing railroad practice, have been international in character and count among their members many Canadians, as well as members from among the dwellers in Mexico. The test of eligibility for membership in these associations in the United States, Canada and Mexico is simply that of professional fitness.

It was in the reign of King William IV, that the act of

parliament was passed authorizing the construction of the first bit of Canadian railway. This was in 1836 and the road joined the town of St. Johns with that of Laprarie in what was then called Lower Canada. It was operated with horses at first but the following year locomotives were used. Subsequent acts authorized the building of other railways, among the first was an act styled 8 Vic., Chap. 25, which thus epitomizes the fact that it was passed in 1845 being the eighth year of the reign of Queen Victoria, and was the 25th act of parliament in that year. This act created the St. Lawrence and Atlantic Railway. Next came the Montreal and Lachine road, authorized by 9 Vic., Chap. 82, or in the year 1846. This short road ultimately became part of what is now known as the Grand Trunk System.

The first locomotive which came to Canada was built by the firm of Robert Stephenson & Co., of Newcastle-upon-Tyne, in 1836. This locomotive was used on the St. Johns and Laprarie railway and is spoken of by Mr. Herbert Wallis in a valuable article on the Centenary of the Steam Locomotive, published some years



Herbert Wallis

ago. Mr. Wallis was for many years mechanical superintendent of the Grand Trunk Railway and it is from his intimate knowledge of facts and dates and his statement of them, concerning railroads in Canada, that much of our information concerning the early days in the land of the maple leaf, is necessarily drawn. This pioneer locomotive is described as having cylinders 9 by 14 inches, four driving wheels 48 inches in diameter. The boiler was 27 inches in diameter and 78 inches long. It contained 64 tubes,  $1\frac{5}{8}$  inches outside diameter. The firebox measured  $18\frac{3}{4}$  inches long, 43 inches wide and 28 inches deep. The total weight of the engine in working order was

12,544 pounds. Mr. Wallis believes that this engine was called the "Dorchester."

The claim of having had the first locomotive in Canada has been put forward in favor of Nova Scotia. But it is probable, from information available at the present time that the Stephenson engine of 1836 was actually the first engine to come to Canada. It is stated by Pangborn in the "World's Railway," published in 1894, that Timothy Hackworth, who was the locomotive engineer of the Stockton & Darlington Railway in England, rebuilt a four-cylinder engine which had been constructed in 1826 by the Wilsons of Newcastle. Hackworth did this in 1827 and the rebuilt engine was called the "Royal George" and was used upon the Stockton and Darlington road.

Pangborn states that the "Samson," a Hackworth engine, was the first engine sent to Nova Scotia. An engine of the same name built by R. Stephenson & Co. had been used on the Liverpool and Manchester Railway in 1831. Hackworth's "Samson" was a six-wheel coupled locomotive while the Stephenson engine of this name was a four-wheel coupled. The Hackworth "Samson" which came to Nova Scotia was built in 1837. The description given of this engine shows it to have somewhat resembled Hackworth's earlier rebuild, called the "Royal George." The description given of Hackworth's "Samson" is as follows: "It is a six-wheeler, with all wheels coupled. The boiler is horizontal and has return tubes, the fire-box and smoke-box being at the same end. The cylinders are double acting located vertically above the back pair of driving wheels and secured to the boiler. The piston-rods extend through the lower heads of the cylinders and connect with a system of levers giving a parallel motion, and the connecting rods are attached to the back drivers. The valves are worked by four eccentrics, two for each valve, placed on the back axle. The valve arrangement is very complicated and located in a recess in the back end of the boiler. At the front end of the engine an iron basket is hung, in which to burn fagots to light the way at night."

The second locomotive to reach Nova Scotia, and the third in Canada, was a Hackworth engine called the "Albion." It was built in 1839 and was like the "Samson": a six-wheel coupled engine. The boiler was a multitubular horizontal one, with a circular fire-box in the waist. As a basis of comparison with the two Canadian engines built by Hackworth, it may be

stated that the "Royal George," which they are said to resemble, was an engine with cylinders 11 by 20 inches, with boiler 13 feet long by 4 feet 4 inches in diameter.

Next in order of time were two engines called respectively the "James Farrier" and the "Montreal." These engines were brought to Canada in 1847 from Scotland and were for the Montreal and Lachine Railroad, and about the same time the "John Molson" was brought out for use on the St. Johns and Laprarie Railway. These three engines were built by Messrs. Kinmond, of Dundee, Scotland, and were similar to the locomotives built some years earlier by the same firm for the

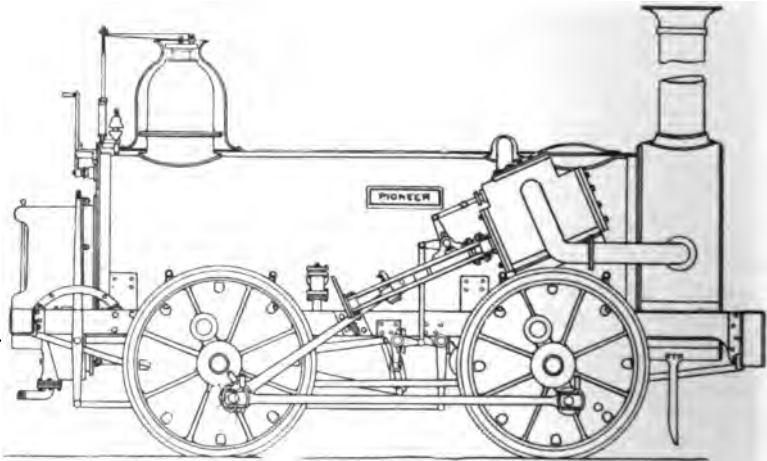

The "Pioneer" Locomotive, Built by Robert Stephenson & Co., in 1850. First Engine on the St. Andrew and Quebec Railway. It Ran on 45 Pound U-Rails

Dundee and Arbroath, the Dundee and Perth, and the Glasgow, Paisley and Ayr railways.

It may be here mentioned that about the same time two similar engines were shipped by this firm for use on the Demarara and Georgetown Railway and were thus the first locomotives to cross the South Atlantic Ocean. They bore names appropriate to the country in which they were to be used, being called the "Firefly" and the "Mosquito."

The Scottish engines in Canada gave excellent service. One of the Montreal and Lachine engines was in use for twenty-eight years which brought its period of retirement down to 1875. The driving wheels were forged from the best wrought



iron, with hubs, spokes and rims carefully welded together by hand. It is stated that the "Montreal" took a train out of the Bonaventure station in Montreal, on the opening of the road, and made the run to Lachine, a distance of between 7 and 8 miles, in eleven minutes, and performed the return trip in  $8\frac{1}{2}$  minutes.

The illustration shown is a reproduction of the photograph of one of the same type of locomotive used on the Dundee and Arbroath Railway in Scotland, and which was built in 1838.

From the information available it seems that the engines



Engine Built by Messrs. Kinmond of Dundee, Scotland. Similar Engines were sent to Canada, in 1847, for the Montreal and Lachine Railway

in Canada up to this time were the "Dorchester," 1836, built by Robert Stephenson & Co.; the "Samson," 1837, built by Timothy Hackworth; the "Albion," 1839, Hackworth; the "James Farrier," the "Montreal," and the "John Molson," 1847, the last three built in Scotland.

The first locomotives brought into Canada West, as the Province of Ontario was then called, was in 1851, when one from the United States and one from England arrived. These engines came to Toronto for use on a small road known as the

Ontario, Simcoe and Huron Railway. An interesting bit of railroad history is connected with these engines.

Mr. W. T. Hockett brought the first locomotive to Toronto, Can., from the United States. In 1851 the Ontario, Simcoe and Huron Railway was begun, but although the persons in authority on that line were not particularly in favor of engines from this side of the line, it was nevertheless determined to give a fair trial to engines from England and the United States before the road was fully equipped.

An engine built in each country was prepared for the test, and Mr. Hockett was given the task of taking across Lake Ontario an engine built in this country. This engine was named the "Lady Elgin," as a compliment to the wife of the Governor-General of Canada, and a speed competition took place between Mr. Hockett's machine and an English engine named the "Josephine." It appears that in this contest the "Lady Elgin" had the lead, but while making a stop for water the "Josephine" caught up with and passed her rival. The result was that engines of English manufacture had the preference on the Ontario, Simcoe and Huron.

The first locomotive built or rebuilt in Toronto was in 1853. It was turned out of the shops of James Good, for the Ontario, Simcoe and Huron Railway. An account of the first train run over this road was given in the Toronto "Globe" of May 16th, 1903, and is as follows:

"Fifty years ago to-day, May 16th, 1853, the first passenger train run in Ontario traveled from Toronto to Aurora, the terminus for a short time of the Ontario, Simcoe and Huron Railway. The train was pulled by an old-fashioned wood-burning locomotive. The ticket office was not completed, and the first conductor, Mr. John Harvie, who is at the present time secretary of the Upper Canada Bible Society, sold tickets upon the platform, as well as upon the train. There were thirty passengers, including a number of directors and officials, and the promotor, Mr. T. C. Capreol. Among the directors were Judge J. C. Morrison, Hon. John Beverley Robinson, afterwards Lieutenant-Governor; Hugh Scobie, then business manager of the 'Globe,' and Duncan MacDonald, a wholesale merchant. Among the officials were the superintendent, Alfred Brunel; the treasurer of the company, Wm. Sladden; and the master mechanic, Wm. Hockett. The engineer was Carlos McCall and the fireman Joe Lopez. The curious thing about the crew was that there

were four brakemen, one to control the brake at either end of each car. Mr. Harvie is to-day (1903) the only survivor of the crew and passengers, and is in his 71st year. He afterwards rose to be superintendent of the road. Mr. Harvie states that the passenger cars of those times were shaped like box cars with flat roofs. The entire equipment of the road at this dawn of railroading in Canada West was two box cars, one passenger car, one combination passenger and baggage car, and two engines, named 'Toronto' and 'Lady Elgin.' The journey to Aurora was accomplished in two hours, and for some time after the opening of the road, thousands watched the arrival and departure of the daily train."



Engine Named the "Toronto," from the shops of James Good, in Toronto, 1853

From this it appears that the "Lady Elgin" was the engine which Mr. Hockett brought to Canada in 1851, and that the engine which is shown in the illustration was the "Toronto," which probably pulled this first train, was turned out by James Good in that city. Whether this engine, the "Toronto," was a new engine or was the "Josephine" rebuilt by Mr. Good, and renamed, does not certainly appear, but the statement by the "Globe" in 1853 that the Ontario, Simcoe and Huron Railway only possessed two engines gives probability to the latter surmise. The Ontario, Simcoe and Huron Railway subsequently became part of the Northern Railway before it was acquired by the Grand Trunk. The distance from Toronto to Aurora is about 30 miles.

In 1853 the Grand Trunk Railway was projected. It was

intended to be "a Main Trunk Line of Railway throughout the Province." Its gauge was 5 feet 6 inches and it included the Grand Trunk Railway of Canada East, the Quebec and Richmond Railway, the St. Lawrence and Atlantic Railway, the Grand Junction Railway and the Toronto and Guelph Railway.

The St. Lawrence and Atlantic Railway was leased in perpetuity and this road, of which 250 miles was then open for traffic, extended practically from the United States boundary to the city of Portland, Me., a total distance of 1,112 miles. It may be stated that the Bonaventure station in Montreal, which was originally the property of the Montreal and Lachine railway, was acquired with that road, by the Grand Trunk, and is the name of the terminal in that city to-day, and it may not be out of place here to mention the origin of the word "Lachine" which is the name of the famous rapids on the St. Lawrence River above Point St. Charles, where the headquarters locomotive and car shops of the Grand Trunk Railway are situated. La Chine is French for China, and when Jaques Cartier, the French explorer discovered the St. Lawrence River in 1535, he found his westward progress barred by these rapids, beyond which he conjectured lay the vast extent of the Chinese Empire.

About 1854 the Grand Trunk Railway imported fifty engines from England, these were built by Messrs. Peto, Brassey, Betts and Jackson at what they called the Canada Works, at Birkenhead, England. The delivery of these engines extended from 1854 to 1858. They were built somewhat after the style of engines then in use on the London and North-Western Railway in England. Some of these engines had cylinders 15 inches in diameter and some 16 inches. Four had 17-inch cylinders but all had a stroke of 20 inches. The passenger engines of this class were what are called "Singles," that is, they had one pair of driving wheels, 72 inches in diameter, while the freight engines had each two pair of 60-inch drivers. The boiler pressure was 110 pounds and the weight of the engines was in round numbers about 60,000 pounds. The cylinders were outside the frames and were inclined, that is, the front was higher than the back. Plate frames were used. The boilers were made of Low Moor iron. The fire-boxes were made of copper and the tubes, of which there were 170, were made of brass,  $1\frac{7}{8}$  inches outside diameter. The engines were originally built with one pair of leading wheels, according to English practice, but these

were changed to four-wheel trucks after their arrival in Canada. These engines gave excellent service, and after eighteen or nineteen years of hard work, thirty of them were sufficiently well preserved to be worth changing to standard gauge engines in 1873, when the 5-foot 6-inch gauge of the road was altered to 4 feet 8½ inches.

One of these old freight Birkenhead engines was, until a few years ago, used on the Carillon & Grenville Railway, a short line operated by the Ottawa River Navigation Co. The engine, which was in active service in 1904, was described in



Old Grand Trunk, "Birkenhead," Engine, built 1854, in Service on the Carillon & Grenville Railway, in 1902

"Railway and Locomotive Engineering," in April of that year: "The cylinders are 15 by 20 inches and the driving wheels are 60 inches in diameter. The cylinders are on the outside, but the valves are old fashioned D-slide valves and are inside, and are so placed that they run on their edges, if one may so say. The boiler is 48 inches at the smoke-box end. There are 180 brass flues, 1⅞-inch diameter, each with a length of 10 feet 6 inches. The fire-box is 3 feet 6 inches by 3 feet 10 inches and is 4 feet high. The fire-box and boiler are both made of Low

Moor iron. The flue sheet is  $\frac{1}{2}$ -inch thick, and the fire-box sheets are  $\frac{3}{8}$ -inch thick.

"The throttle valve is an interesting piece of mechanism. It is a hollow brass valve of the plunger type, fitted into a cast-iron cylinder. The cylinder is flanged at both ends, one flange is bolted to the inside of the back sheet. The forward end of this cylinder is bolted to the dry pipe, thus making a solid stay between back sheet and front flue sheet. Another pipe comes down from the top of the dome and connects with this cast-iron cylinder, which supplies steam to the cylinders



G. T. R. Engine 209, the "Trevithick," First Engine Built by the Grand Trunk Railway, at Montreal, in 1859

when the plug valve has been drawn back. Two brass guides are attached to the stuffing box flange, of the inclined plane or wedge type. The throttle handle extends up through the guides, and as the engineer pulls the handle from left to right, the inclined plane guides force the valve from its seat and the pulling back of the valve admits steam to the dry pipe.

"The rigid wheel base is 7 feet. The total length of the engine is 21 feet. The tender is 17 feet 6 inches, and the total length of engine and tender is 38 feet 6 inches. This interesting locomotive is one of the oldest machines, if not itself the oldest, which is in active service at the present time (1902)."

"The first engine built at the Grand Trunk shops was designed by Mr. F. H. Trevithick, the first locomotive superintendent of that road. He was a nephew of Richard Trevithick. This engine was completed in 1859 and was named the "Trevithick." The weight in working order was 65,000 pounds. The cylinders were 16 by 20 inches and the diameter of the driving wheels was 60 inches. The boiler pressure carried was 120 pounds per square inch, and the engine had connecting rods forked about the middle, so that the fork ends passed on each



Old Victoria Tubular Bridge Over the St. Lawrence, Grand Trunk Railway,  
Montreal, Canada

side of what we would call the guide yoke, and grasped the ends of the wrist pin on each side of the cross-head. It was No. 209 on the railway. We are indebted to Mr. James Haynes, E.E., of the Ecole Polytechnique, Montreal, for the now very rare photograph from which our engraving has been made, and for the dimensions given."

In 1860 the Victoria Bridge was opened for railway traffic. This was one of the largest and most important bridges in the world. It crossed the St. Lawrence, near Montreal. It was a box girder or tube of rectangular shape made of iron plates,

riveted together. The total length of this bridge was, with approaches, 9,144 feet. It was built with 24 spans, each about 242 feet long, and the center one was 330 feet long. The greatest depth of the river is about 22 feet, and the average rate of the current



H. R. H., the Prince of Wales (in Centre of Group), now King Edward VII., as He Appeared with Staff, When Inaugurating the Victoria Bridge, 1860

is about 7 miles per hour.

The bottom of the center tube was 60 feet above the water, and at the abutments the bottom of the tube was, of course, very much lower, so that there was a rise of 1 in 130 towards the center of the bridge from each end. This was for the purpose of clearing the channel for vessels passing down the river. An idea of the magnitude of this structure may be had from the fact that 9,000 tons of iron were used in making the tubes, and the plates were held together by about  $1\frac{1}{2}$  million of rivets. The total surface of iron was 32 acres. There were 2,713,095 cubic feet of masonry in piers and abutments. Upwards of 3,000

men were employed in building it. The first stone was laid on July 20th, 1854, and the first train passed over on December 17th, 1859. It was formally inaugurated in 1860 by the Prince of Wales, now Edward VII, when, as a young man, he visited Canada, in making a tour of the world. The engineers of the Victoria Tubular bridge were Robert Stephenson and Alexander M. Ross. The first stone of the first pier was laid by Sir C. Roney, on the 22d of July, 1854. The bridge was replaced about 1898 by an openwork steel lattice girder bridge carrying two railway tracks and two roadways for vehicles and pedestrians.

Following Mr. Trevithick as locomotive superintendent, came Mr. W. S. Mackenzie who had previously been Mr. Trevi-





Baldwin Engine, No. 244, on Grand Trunk, 1873

thick's assistant. In 1836 Mr. Richard Eaton succeeded Mr. Mackenzie, as mechanical superintendent of the Grand Trunk Railway. He had been in charge of the locomotive department of the Great Western Railway of Canada, a road which extended from Clifton, on the Niagara River, to Sarnia on the St. Clair River. Mr. Eaton held office until the change of gauge in 1873. He was the first in Canada to use steel for locomotive boilers. One of the engines he designed in 1861, while on the Great Western, had a boiler entirely made of steel. Many of the engines he built at the Grand Trunk works had slab frames, cylinders 16 by 20 inches; driving wheels, in some cases, 66 inches in diameter, and in others 60 inches; the steam pressure was 135 pounds, and the engines weighed about 65,000 pounds. The Eaton boilers were generally of the straight top type and had rigid plate staying between crown and roof sheets.



Schenectady Passenger Engine, on G. T. R., 1873

The year 1873 was memorable on the Grand Trunk for the change of gauge which was accomplished in an exceedingly short space of time, considering the nature of the work. On some portions of the road one rail only was shifted over against marker spikes already driven so as to give approximately the position of the rail, then the track was accurately gauged and the rail spiked in place. Mr. Eaton retired in 1873 and was succeeded as mechanical superintendent by Mr. Herbert Wallis who took office 1st of January, 1873, and held this responsible position for twenty-three years.

During 1873 and 4, one hundred and sixty-one engines were imported from the United States, of these 61 came from the Manchester, N. H. Locomotive Works. These engines were known on the road as Blood engines, as they bore the name Aretus Blood agent, on the builder's name plate. The Baldwin Locomotive Works, of Philadelphia, built 45 engines of the type shown in the engraving of G. T. R. 244. The Schenectady Locomotive Works, of Schenectady, N. Y., built 20 passenger engines, often called McQueen engines from the fact that Walter McQueen was superintendent of the works. The Rhode Island Locomotive Works built 15 engines and the Portland Locomotive Works built 20 at Portland, Me.

During the same time, the Canadian Locomotive and Engine Co., Ltd., of Kingston, Ontario, and the Grand Trunk shops at Point St. Charles, Montreal, built new engines and converted 135 engines from broad to standard gauge. The new locomotives were practically alike, having 17 by 24 inch cylinders, four coupled driving wheels of 60 or of 66 inch diameter, and they carried a boiler pressure of 145 pounds. They weighed in working order about 70,000 pounds. These engines were all coal burners. No wood burning engines having been built for use on this road after 1872.

During the incumbency of Mr. Wallis, the advance in locomotive design was as rapid as it was typical of the general progress made in railway development all over the world. In 1874 the 2-6-0 type or "Mogul" type of locomotive made its appearance on the Grand Trunk, ten being imported from the United States, and between that year and 1896 about 170 of these engines were either bought, rebuilt or built by the Grand Trunk. The first Grand Trunk compound Moguls, begun in 1905, were built in the Point St. Charles shops of the com-

pany at Montreal, under the supervision of Mr. Wallis. They were of the cross-compound type and the cylinders were 19 and 29 by 26 inches. The steam pressure was 190 pounds, and the weight in working order was about 118,412 pounds. These engines were capable of hauling trains of 1,109 tons at an average speed of 21 miles per hour. Many and substantial improvements took place on the Grand Trunk in all departments, during these twenty-three years. Heavier rails kept pace with the increasing weight of engines and cars. Bridges were rebuilt, new lines were acquired, and double tracking of important sections of the road were accomplished.

Mr. F. W. Morse who succeeded Mr. Wallis in 1896 with the title of superintendent of motive power, continued the use



Modern 4-6-0 Passenger Engine, for the Intercolonial Railway, Built in 1899, at Canadian Locomotive Works, Kingston, Ont Cylinders, 20 x 26 Inches Drivers, 72 Inches ; Weight of Engine, 145,000 Pounds

of the compound 2-6-0 type, but the weight and capacity of these later day machines was much greater and the haulage capacity increased up to 2,000 tons. New ten-wheel and other types were built or imported.

Some years later Mr. W. D. Robb became superintendent of motive power of the Grand Trunk system, Mr. Morse having been advanced to the vice-presidency of the company. Typical examples of modern Grand Trunk freight and passenger engines are shown in the illustrations, the photographs of which were received from Mr. Robb, who is still head of the motive power department. The mileage of the Grand Trunk system, as reported to the Government of the Dominion on June 30, 1906, was 3,111 miles.

Before leaving the Grand Trunk, which ranks as the pioneer railroad in Canada, it may be remarked that the building of locomotives began in Canada, as we have already pointed out, in 1853 when James Good at Toronto, Ont., built or rebuilt the "Toronto" for the Ontario, Simcoe and Huron. The Kinmond Brothers, of Montreal, also delivered to the Grand Trunk Railway an engine later in the same year. The Ontario Foundry Company, of Kingston, Ont., later the Canadian Locomotive and Engine Company, Ltd., built four engines in 1856 for the Grand Trunk. Mr. D. C. Dunn, of Hamilton, Ont., delivered three engines in 1857. Fleming & Sons, of St. John, New Brunswick, began to build locomotives about 1865. The Great Western Railway is believed to have built locomotives at their Hamilton, Ont., shops in 1857. The Intercolonial Railway built engines at Moncton, N. B., in 1877, and the Canadian Pacific, at Montreal, in 1883.

The Intercolonial Railway was opened in 1876, the year when the various provinces confederated as the Dominion of Canada. This road was built and operated by the Federal government and is a concrete example of what is known as a state-owned railroad. It touches six Atlantic ocean ports, namely: Point du Chene, N. B.; Pictou, N. S.; Halifax, N. S.; St. John, N. B.; Sydney, C. B.; and North Sydney, C. B. It also reaches Montreal, Que., and Quebec, Que., on the St. Lawrence River. The total length of the road June 30, 1906, was 1,457 miles. The general offices and the railway shops are situated at Moncton, N. B. The equipment consists of 347 locomotives, 430 passenger cars, 10,820 freight cars and 128 tool cars, snow ploughs, etc.

The report for 1906 of the Canadian Minister of Railways and Canals contains the following, which shows the tendency to standardize railway methods on this continent, as well as that of locomotive practice. "A very important measure has been adopted in connection with the account system of the Intercolonial, which will have a far reaching and satisfactory effect in the future handling of this important branch. The system has now been brought into conformity with that in force on the leading Canadian Railways and on the railways of the United States as laid down by the Interstate Commerce Commission, and, as a result of such conformity, the vexations and troublesome discrepancies that have heretofore embarrassed the road in its dealings with other roads will disappear, and har-

monious working out of the various complicated questions constantly arising between them will be attained."

The Prince Edward Island Railway was also built and is operated by the Dominion Government. It is a road of 3 feet 6 inches gauge and has a total of 261 miles. The equipment of this road consists of 27 locomotives, 57 passenger cars, 430 freight cars and 19 snow ploughs and flangers. An example of one of the Prince Edward Island narrow gauge locomotives is shown in the illustration. Four of these engines were built at the Canadian Locomotive & Engine Co.'s works, at Kingston,

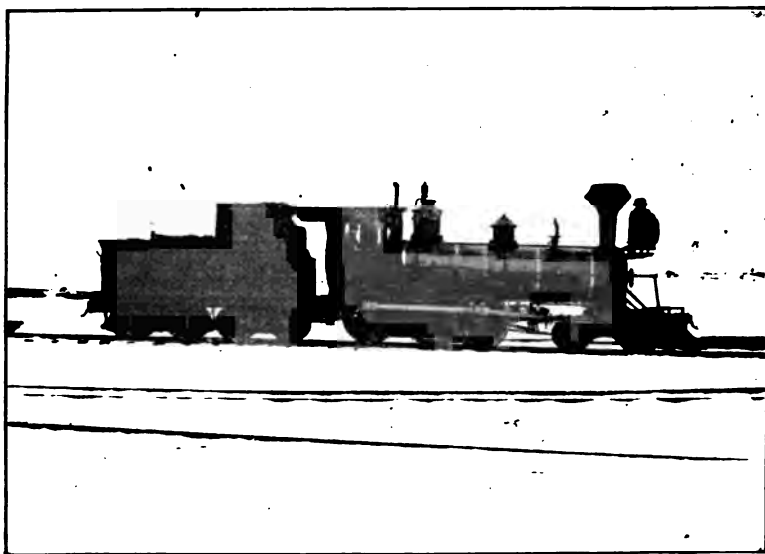

Prince Edward Island Railway Engine, 3 Feet 6 Inch Gauge, Built About 1881, by Canadian Locomotive & Engine Co., Ltd. Cylinders, 13 x 18 Inches; Drivers 47 Inches; Weight of Engine, 45,300 Pounds

Ont., about 1881-2, and the writer, who was draughtsman of the works at the time, prepared the drawings from which the engines were built.

The Canadian Pacific Railway was incorporated in February, 1881, by Letters Patent under the Great Seal of the Dominion of Canada, for the purpose of constructing and operating a line of railway between the Atlantic and the Pacific seaboards, entirely within Canadian territory. The charter was granted in pursuance of a contract made between the Government and certain individuals on behalf of the company and under the

authority of an Act of the Dominion Parliament. Viewed in this light the enterprise was, in a sense, a national undertaking. The Act conferred large powers on the company, such as the right of constructing branches along the entire length of the road, of establishing lines of ships or steamers at its termini, and of constructing and working telegraph lines for the business of the public as well as for their own use.

The entire line was constructed with a view to efficient and economical operation. Steel rails of the best quality, weighing 80 pounds per yard and upwards, are used throughout, and all important structures are of a permanent character. Care was taken to secure the lightest possible grades, and in this respect the Canadian Pacific compares favorably with other trans-continental lines.



Modern Vaucain 4-Cylinder Compound Passenger 4-4-2 Engine, Built at Canadian Pacific Shops, Montreal, in 1898. Cylinders,  $13\frac{1}{2}$  and 23 x 26 Inches; Drivers 84 Inches; Weight of Engine, 170,250 Pounds

The road east of Lake Nipissing traverses in greater part an old and well developed country, and commands the lumber traffic of the upper Ottawa Valley. From Callander, westward, and throughout the whole of the Lake Superior section, the line runs through many forests which have furnished fuel and lumber to settlers on the praries; this part of the line also passes through mineral lands abounding in iron and copper.

Considering the course taken by the company's steamships on the Atlantic and Pacific Oceans, and the directness of the company's line across the continent, its rail and ocean operation materially shortened the time occupied in the journey between the ports of China and Japan and those of Great Britain and the continent of Europe.

It is in the development of Western Canada that the fruits of the company's labors are, perhaps, most marked. A development which began with the completion of the railway in 1886. Western Canada, i.e., the provinces of Manitoba, Saskatche-



Modern 2-8-0 Freight Engine, on Canadian Pacific Railway. Cylinders, 21x28 Inches Drivers, 57 Inches; Weight of Engine, 186,200 Pounds; Steam Superheated

wan, Alberta and incidentally New Ontario, covering in round numbers 600,000 square miles, embrace within their combined limits the available agricultural regions of Western Canada. In area they are three times the size of the German Empire and five times larger than Great Britain and Ireland. Nearly one-



Modern 4-6-2 Passenger Engine, on Canadian Pacific Railway. Cylinders, 21 x 28 Inches; Drivers, 69 inches; Weight of Engine, 214,300 Pounds  
Steam Superheated

half of this area, or about 200,000,000 acres, are fit for cultivation, and nearly all will produce wheat.

The Canadian Pacific Railway has under construction and partly completed one of the largest irrigation schemes on the American continent. This scheme embraces an area of some

3,000,000 acres lying east of Calgary, Alb., between the Bow River and the Red Deer River. Of this area the company expects to be able to supply water to irrigate about 1,500,000 acres. Canals have already been completed which are capable of furnishing water for irrigating 110,000 acres. Work is being prosecuted on a second canal, for the purpose of bringing water for about 200,000 additional acres.

In 1905 the company secured the necessary legislation and acquired control of the Esquimaux & Nanaimo Railway on Vancouver Island, extending from Victoria, B. C., to Wellington, B. C., a distance of seventy-eight miles. The construction of the second track between Winnipeg and Fort William is proceeding, and it is expected that the work will be completed in



Modern 2-8-0 Compound Freight Engine, Built by Grand Trunk Railway, Montreal Shops. Cylinders, 22½ and 35 x 32 Inches; Drivers, 63 Inches  
Weight of Engine, 211,200 Pounds

about three years. The total mileage of the Canadian Pacific Railway is 9,425, of which about 3,337 is leased. The number of locomotives is 1,115 and a total of 37,080 cars make up their rolling equipment.

As reported for the fiscal year 1906, the total railway mileage of Canada is 21,518 and 4,085 miles of sidings. The number of miles in operation is 21,353, and there are 878 miles of double track. There are, not including the two government roads, 94 companies controlling railways in Canada. The rolling stock amounts to 2,931 locomotives, 2,477 passenger cars, 99,914 freight cars and cars used for maintenance and operation. Of these 86,442 were equipped with air brakes, and 91,182 were fitted with M. C. B. automatic couplers.



There is in Canada a board of Railway Commissioners, which was created by Act of Parliament to supersede the Railway Committee of the Privy Council, and the appointment of the three members of which the commission consists is made by order in council. The office of the commission is in Ottawa, but it is authorized to hold sessions in any part of Canada. Its decisions are final, subject to appeal to the Supreme Court upon questions of jurisdiction or law, and also to action thereon by the Governor in Council in his discretion. In these, as in other matters the action of the Governor-General is based upon advice of the Premier.

The latest form of railroad development in Canada is the National Transcontinental Railway. This is practically the outcome of an agreement entered into by the Grand Trunk



Modern Ten-Wheel Passenger Engine, Built by Grand Trunk Railway, Montreal Shops. Cylinders, 20x26 Inches; Drivers, 73 Inches; Weight of Engine, 182,000 Pounds

Pacific Railway Company, a newly created corporation closely allied with the Grand Trunk Railway, and the Dominion Government, for the construction of a line of railway wholly upon Canadian territory between Moncton, N. B., and the navigable waters of the Pacific Ocean. The government are constructing the eastern division of the Grand Trunk Pacific, which is from Moncton to Quebec. This will be leased for 50 years to the company, the first seven years to be free of rent. The company are building the line from Quebec to British Columbia and both divisions are to be equipped by the company. When completed this will give Canada two transcontinental railway systems and open up to the world the vast mineral resources and the wide wheat fields of the great North Land.

# The Locomotive of To-Day

## CHAPTER XXXIII.

### Controversies About Locomotive Proportions.

In the course of its development certain features of the locomotive have been the subject of curious controversies. The size of boiler and grate area in relation to the size of cylinders and driving wheels led to no end of unprofitable discussion. Some of the men who labored on the improvement of the locomotive profited by their ingenious productions, but some of the most valuable im-

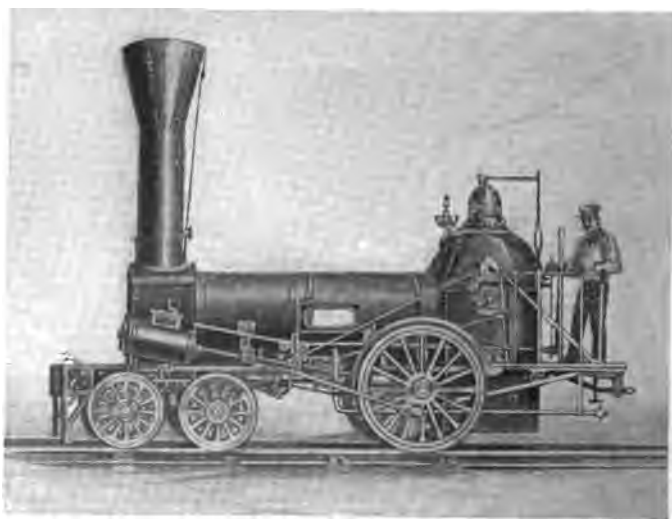

Norris, 1840

provements were never patented, such as valve lap, double eccentrics, link motion, counterbalancing of driving wheels, expansion braces and many other useful details. On the other hand, royalties were paid on many inventions that had no claim to originality and were not devised by the parties claiming to be the inventors.

### Desire for High Speed.

There seems to have been a curious propensity towards building locomotives capable of attaining a speed of not less than sixty miles an hour, even where the track was not safe to carry trains running at half that velocity. They built the high speed engines and learned, in a way not to be easily forgotten, that the boilers would not generate the steam necessary to keep the wheels turning. Associated with big driving wheels were cylinders so large that they used up the steam faster than the small boilers would generate it, which taught the men in charge that there was an intimate relation between the heating surface of the boiler and the size of the cylinders. Large cylinders also produced excessive

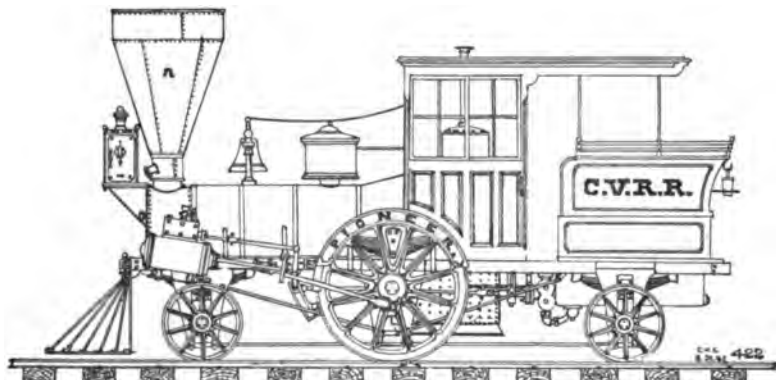

"Pioneer," Built in 1851 by Seth Wilmarth for Cumberland Valley Railroad

slipping of driving wheels, when the weight thereon was insufficient; so through expensive blunders the pioneer locomotive designers and master mechanics found out the proportions likely to produce a good working locomotive.

### Proportions of Cylinders—Long and Short Stroke.

For years the length of stroke was a matter of controversy, some designers favoring a stroke decidedly longer than what afterwards became close to an established rule, while others favored making the length of stroke nearly that of the diameter of the cylinder.

When the Crampton engine "Stevens" was designed by Robert L. Stevens and Isaac Dripps, the cylinder proportions settled on were 13 inches diameter and 3 inches stroke. The first engine built of that type being found deficient in tractive power,

a thing not to be wondered at with its driving wheels 8 feet diameter, the designers determined to increase the piston stroke of succeeding Crampton's to 38 inches. The change did not prevent the locomotives from being failures, but that stroke was the longest ever tried for locomotives.

In two engines with a single pair of driving wheels 7 feet diameter, built by William Norris in 1850 for the Erie Railroad, the cylinders were 14x32 inches. The experience gained with these engines indicated to designers that a shorter stroke with larger bore of cylinder would produce better results.

The proportions of grate area to boiler heating surface and the proportion of heating surface to cylinder content of locomotives were all established by a tentative process—they tried certain dimensions and those that were found to produce the best results were considered about right.

#### Proportions of Heating Surface and Grate Area to Cylinder Capacity.

The boiler is the real measure of the capacity of a locomotive, but the cylinders are the measure of power and the proportions of heating surface and grate area ought to be based on the capability for generating the volume of steam required by the cylinders. In the early days of locomotive operating technical writers describing the working of an engine generally mentioned the volume of steam drawn from the boiler by each stroke of the piston. That practice gradually came to be neglected, probably because it involved tedious calculating, which the ordinary newspaper men could not work out; but the size of cylinder is certainly the most important feature of the design, although its existence has almost been smothered sometimes by detailed descriptions of heating surface, grate area, smoke box capacity, size of smoke stacks, exhaust nozzles and a variety of other matters that in themselves are comparatively unimportant—mere distant corollaries of the cylinders.

As the cylinders are the vessels through which the power for driving an engine is applied, many attempts have been made to use cylinders that were too large for the steam supply, but it acted like the analogous case of trying to work a horse very hard on an insufficient supply of food. For several decades a practice prevailed on American railroads which indicated that certain officials thought that by judicious humoring, an engine could be made to do work away beyond its natural capacity. A locomotive with

certain size of cylinders was found to be capable of hauling, say, 500 tons over the limiting grade of a division. The officials knew enough about cylinder capacity to figure that an increase of one inch in the diameter would increase the tractive power about 15 per cent. and enable the engine to haul 75 more tons. Then the cylinders have been increased without any other part being changed, and general disappointment ensued because the new engines were scarcely so efficient as those with the smaller cylinders. It was the ancient attempt of trying to force a quart into a pint bottle.



Built in 1860 by Richard Norris & Son for Eastern Texas Railroad. Captured by Federal Troops During the War. One of the Last Locomotives Built in Norris Works

I have already mentioned that the proportions of stroke and diameter of cylinders of the Stephenson "Planet" locomotives used by the Locks & Canals Company, of Lowell, Mass., as a pattern in designing the engines they built, had the diameter about seven-tenths of the length of stroke and that that proportion became practically standard with all locomotive designers. It seems to have been a case of natural selection, for I never saw the figures quoted, but investigation will prove that nearly all successful locomotives have had cylinder proportions that did not vary far from those of the Planet.

It will be interesting for students of the growth of the locomotive to examine the development of the locomotive as found in the proportion of cylinder content to that of heating surface and grate area. I produce a table of the most important proportions of locomotives representing the whole of the history of loco-

motive building. The proportions of heating surface and grate area to the cylinder content are an interesting study. It will be found that the Planet had 1.66 cubic feet of cylinders and that the ratios of heating surface and grate area were 245.1 and 3.91, respectively. That was a liberal proportion both of heating surface and grate area and is close to modern practice. Locomotives that have been built with proportions radically different have been failures, the most conspicuous among them having been the "Lightning," built by Richard Norris in 1849, with 132.4 square feet of heating surface and 2.63 square feet of grate to the cubic foot of cylinder. With the steady increase of cylinder capacity that has been advancing for forty years, it will be seen that the heating and grate surfaces have always been made more liberal in proportion to the size of cylinders.

It will be noted by the annexed table of dimensions and ratios of representative locomotives that the ratio of cylinder content to grate area kept fairly constant up to the last representative of the 4-4-0 type, which is the New York Central 4-4-0, the famous 870. There are two exceptions in Baldwin's first engine and Winans' Camel, both of which approaches modern ratios. With the introduction of the 4-4-2 express locomotive the ratio of grate almost doubles previous practice, although the cylinders are greatly increased in power to meet the greater duty required.

The figures given in the annexed table relate almost exclusively to passenger locomotives.

Throughout these chapters I have traced the growth of the locomotive engine from a machine of four or five tons weight, capable of developing less than ten horse power, to the immense aggregations of steel and iron that weigh over two hundred tons and have capacity for doing work in proportion to the size and weight.

### Aim of Early Designers.

For the first forty years of railroad operating, the dominating aim of designers and locomotive builders was to produce a locomotive suitable for all kinds of train service, one that would be fairly efficient and durable enough to make long mileage with small expense for repairs and subject to few failures. Except on the comparatively few railroads handling minerals and other heavy freight over steep grades, the eight-wheel locomotive, known for excellence as the American Locomotive, was regarded as an ideal engine for hauling both pas-

## Proportions of Locomotives

LOCOMOTIVES	Dimensions of Cylinders		Cubic Contents of Both Cylinders	Heating Surface	Grate Area	Ratio of Heating Surface to Grate Area	Ratio of Heating Surface to Cylinder Contents	Ratio of Cylinder Contents in Cubic Feet to Grate Area
	Inch.	Sq. ft.						
Stephenson's Planet, 1830.....	11 x 16	407	1.66	6.5	62.6	245.1	3.91	
Baldwin's Ironsides, 1832.....	9½ x 18	208.5	1.47	6.78	30.7	141.5	4.61	
Hinkley Antelope, 1845.....	11½ x 22	463	2.57	8.00	57.9	180.0	3.11	
Griggs, 1845.....	14½ x 18	550	3.44	8.75	62.8	130.8	2.52	
Schenectady Lightning, 1849.....	16 x 22	678.2	5.12	11.12	50.2	132.4	2.63	
Eddy's Gilmore, 1852.....	15¾ x 26	1172	5.6	1025	100.5	210.0	1.99	
Winans, 1848—First Camel.....	17 x 22	814	5.9	10.5	41.7	173.7	4.32	
Caledonian, 1850.....	15 x 20	948	4.0	15.4	77.5	203.5	2.63	
Grant, 1873.....	16 x 24	1335	5.6	16.0	83.5	170.0	2.75	
Northern Pacific, 1883.....	17 x 24	1851.5	6.3	27.3	67.7	195.2	2.9	
N. Y. Central, 4-4-0, 1891.....	19 x 24	2035.4	9.45	28.23	72.1	195.3	2.73	
Baltimore & Ohio, 1891.....	21 x 26	2035	10.42	29.0	70.0	238.5	5.47	
20 Century, N. C. & St. Louis, 4-6-0.....	19 x 26	3230.8	8.53	54.4	59.4	331.7	3.83	
Erie.....	22 x 32	3033	14.2	49.5	61.6	247.7	4.00	
Union Pacific, 1902.....	22 x 28	2640	12.32	55.5	47.5	231.6	4.87	
Pennsylvania, 4-4-2, 1902.....	22 x 26	3340	11.4	35	64.6	340	5.27	
Big Four, 4-4-2, 1903.....	20½ x 26	9.8	9.8	51.7	89.4	312.9	3.50	
Illinois Central, 4-4-2.....	20 x 28	3129.2	10.0	34	71.1	263.6	3.70	
B. A. & Pacific, 4-6-0.....	19 x 26	2507.8	9.18	30.4	82.4	279.2	3.38	
C. & N. W., 4-4-0.....	19½ x 26	3356	8.98	48.5	60.9	314.2	4.54	
L. S. & M. S., 2-4-2.....	20½ x 28	3878.5	10.68	54.25	71.4	315.3	4.41	
So. Ry., 4-6-2.....	22 x 28	3463.7	12.30	45.7	76.1	263.2	4.55	
Nor. & W., 4-6-2.....	20 x 28	2954	10.0	47.7	61.9	263.2	4.25	
Frisco, 4-6-0.....	21 x 28	2979	11.22	43.5	68.4	261.7	3.80	
Nor. Pac., 4-6-2.....	22 x 26	2979	11.42	43.5	68.4	261.7	3.80	

senger and freight trains. In 1870 probably 85 per cent. of the locomotives at work on the American continent were of that type. Until the troublesome problem of how to move passenger and freight trains at the least possible expense became dominant in railroad counsels the American locomotive left nothing to be desired as railroad motive power.

### Case of Natural Evolution.

The engine was the product of natural evolution, the survival of the fittest and altogether admirable as a power produc-



Photographed by F. W. Bleuvelt

"Taunton," 1862. One of the Oldest Inside Connected New England Engines.  
Belonged to Central R. R. of New Jersey

ing motor. Lest this book be read when the American locomotive becomes classed with the dinosaurs, I may explain that it belonged to what is now denominated as the 4-4-0 class having a four-wheel truck under the smoke box and two pairs of coupled drivers in the rear, one pair of drivers in front and one pair behind the fire box. During the period of this engine's glory a deep fire box passed down between the frames and was compactly bounded by driving wheel axles and coupling rods. About one-third of the total weight was generally carried on the leading truck.

### Getting Into Shape.

The perfecting of this form of locomotive represents the most valuable engineering work performed on railroad motive



power. The work of Evans, Trevithick, Hedley, Stephenson, Hackworth, Cooper, Baldwin, Dripps, Winans, Harrison, Eddy, Millholland, Rogers, Cooke and Mason all produc'd contributions to the perfecting of the American locomotive, and very often the permanent gift of what is regarded as a fertile inventor will be identified as a very small part of that finished machine. We find the first groping towards a locomotive machine was a portable boiler with various accessories attached, such as cylinders and wheels. Then came an arrangement of rectangular beams forming a frame which carried the boiler and provided conveniences for holding the four wheels that carried



Baldwin's 4-4-0, 1872. Type Then the Glory of Railroads

the whole combination of power generating and transmitting appliances. For the track's sake the carrying burden is distributed over four pairs of wheels, two of them being in front. The clumsy outside wooden beams that acted as frames are abandoned for iron bars that are not susceptible to changes of temperature and form a light frame which carries the boiler securely and with small superfluous weight to which all operating mechanism is strongly fastened. The engine meets the essential requirements of lightness and strength sufficient to control the increasing power. The elementary locomotive with a single pair of driving wheels is deficient in adhesion and what seems a backward step is taken to make an important move forward. The first engines built before the advent of the swivelling truck were generally carried by two pairs of coupled wheels which

gave sufficient adhesion. In the United States one pair of these wheels was abandoned for the leading truck, while in Europe the four coupled arrangement was adhered to, but a single pair of carrying wheels was introduced in front or in the rear.

### Traction Increases.

When it became apparent in the United States that a single pair of driving wheels made a very slippery engine, various forms of traction increases were resorted to with very little satisfaction. Then an engineer proposed adding another pair of driving wheels, the same pair that had been thrown out by



"C. P. Huntington," Pioneer of the Pacific Coast

the Jervis truck, and won fame and fortune by the invention. The clan Campbell, led by their chief, the Duke of Argyll, have won many victories since, brecksless, they first emerged from the wilds of Lorn, but no victory was so abiding and lucrative as that of Henry R. Campbell when he added a pair of driving wheels to the slippery locomotive.

### First 4-4-0 Locomotive.

Campbell gave the basis for the American locomotive, but it had to pass through much torturing experiments due mostly to following of fallacies and fashions before it emerged from the hands of its friends a highly perfected engine. The Camp-

bell was rudimentary to a degree, but it provided a foundation to succeeding builders. A heavy outside wooden frame carrying a boiler and having pedestals to secure the four-wheel leading truck and the two pairs of driving wheels set very close together formed the visible outlines of the engine. The cylinders were inside under the smoke box and transmitted the power through a cranked axle. This engine, shown on page 134, was patented in 1836. It was noted for unyielding, hard-riding characteristics.



Southern Pacific Engine, with Stevens Valve Motion, 1885

### Equalizing Beams Appear.

A very decided improvement on the Campbell was introduced the following year by Eastwick & Harrison in the "Herculus." This engine had equalizing beams between the driving wheels, the invention of Joseph Harrison, Jr., who made claims to the Patent Office of all the types of equalizers that ever have been applied to locomotives. This was an epochal invention and by degrees worked into universal adoption.

### Counter Balance of Driving Wheels.

Rogers finished his first locomotive the same year that the Herculus appeared with equalizers and Rogers made his initial locomotive celebrated by applying weight in the driving wheels to counterbalance the crank. Coleman Sellers had done this in 1835 on two locomotives he built for the Philadelphia & Colum-

bia Railroad, but he went out of business and the valuable improvement might have been lost for a time had it been overlooked by Rogers. A few years later a decided step in advance was made when Rogers introduced the link motion and another valuable feature appeared when the same builder applied the wagon-top boiler.

### **Baldwin Invents Improvement of Details.**

Before this time Baldwin had invented and applied ground joints, one of the most valuable minor inventions that helped

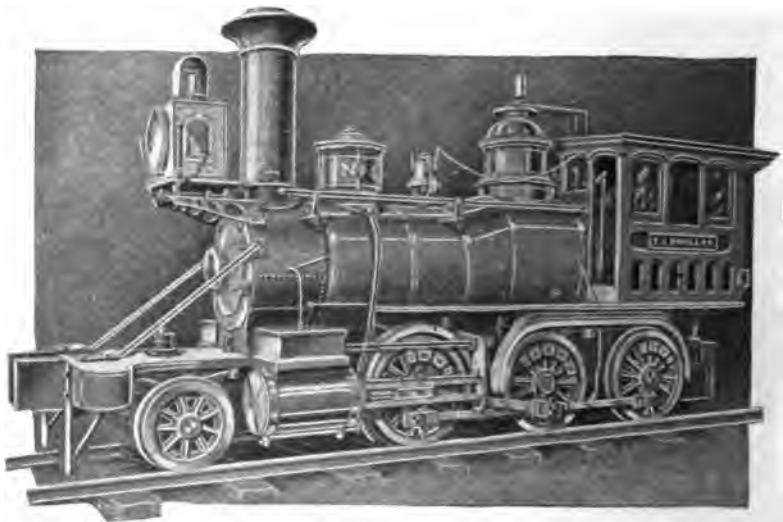

**Mogul of 1867 for Thomas Iron Co., Hokendauqua, Pa.**

to perfect the American locomotive. Another enduring inventions of Baldwin's was brazing a copper ferrule on the end of boiler tubes, an invention that greatly helps to prevent leakage. As early as 1840 Mr. M. W. Baldwin seemed to realize the want of durability in fibrous packing, then universally used in rod glands, for that year he patented metallic packing, now employed on all high steam pressure engines.

Until about 1840 builders of locomotives seemed contented with their work if the engines turned out would haul trains with certainty and regularity. After that attempts began making to improve the appearance of the engine, to provide comfort for the men in charge and to introduce conveniences for handling. Under this sentiment the cab became a recognized feature of

the engine, and parts that required attention on the road were made convenient to reach, while special attention was given to making removal for repairs easy.

### Using the Boiler to Tie To.

For years there was a strong tendency among railroad master mechanics to use the boiler as an object of attachment for frames and even for pedestals. By degrees this was acknowledged to be bad practice, only they must be permitted to use the smoke box as a foundation for the cylinders. A point half way up the smoke box made a yielding location for a heavy cylinder, but it became a fashion that persisted until two or

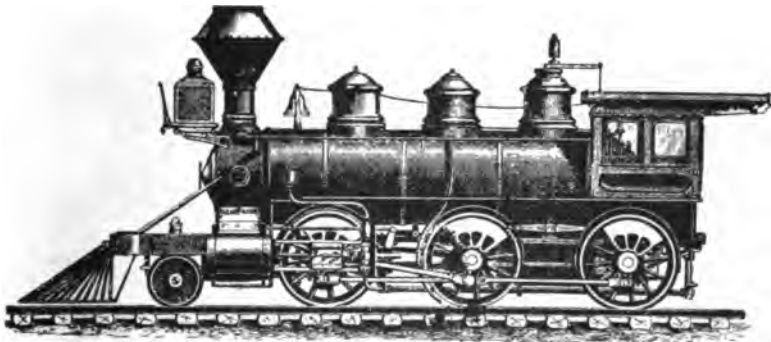

Baldwin's 1874 Mogul

three of the most intelligent designers proved the arrangement to be wrong from an engineering standpoint, and moved the cylinders down to the level of the driving axles. Wilson Eddy, of Springfield, Mass., presented an excellent object lesson when he built his first engine, the Addison Gilmore, which had horizontal cylinders and harmonious appearing outlines. Eddy recognized that the frames that secured the driving wheels made the proper fastenings for the cylinders. His engine represented a sudden jump from the antique to the modern with its level cylinders, divided frames, enclosed cab, sand and cylinder lubrication that could be applied from the cab.

Eddy's first engine was built in 1851. To the credit of the designer, very few improvements were necessary to produce the perfected engine of 1870. Mason spread the truck to give the cylinders room between the wheels and he rubbed some

angular irregularities off the outlines. Various proportions of cylinders with their connections had been established; the boiler capacity and grate area in their relation to cylinders did not differ much in the product of the various makers when the eighth decade of last century opened.

### Zenith of the 4-4-0 Engine.

For about twenty years, the "American" locomotive was the Rome towards which nearly all locomotive designers traveled. It was a pity that the public demand for increased speed of



Pioneer of the Pacific Coast. First Locomotive Built West of the Rocky Mountains. Before the War

passenger trains and decreased freight charges should have moved railroad managers to command that more powerful locomotives should be provided. That was an order which had to be obeyed, and designers proceeded with the task of putting into form the modern locomotive.

The public at large has profited by the exertions of railroad managers to reduce the cost of moving passengers and freight to the lowest possible figure; but railroad owners have not shared in the benefits except to a very limited extent. Increased power of locomotives and augmented capacity of cars

were the weapons that rival railroad companies employed as fighting weapons. The struggle between contestants was not to secure more profit on the business done but to increase their own share of the business with no consideration of the cost.

The "American" locomotive reached its zenith in 1872. In that year the Baldwin Locomotive Works built 422 engines, the average weight in working order having been 64,000 pounds. Most of the engines were of the 4-4-0 type.

### Attempts to Expand.

The favorite 4-4-0 soon reached the limit of its capacity. The grate area limits, the steam producing power of a boiler, and



Old Norris Engine "Franklin," Used for Many Years by Seaboard Air Line for Instruction of Engineers. Ben. Lacy, Treasurer of North Carolina, Was Instructor for a Long Time

the first attempts to increase the capacity of the American locomotive were directed to increasing the size of the grates. The most popular engines of that type had deep fire-boxes passing between the frames, providing a grate about 34 x 72 inches or 17 square feet. The intensity of the popular desire to keep that type of locomotive in use may be judged by the ingenious efforts made to enlarge the grate area. The first movement was increasing the distance between the driving wheels so that the grates could be lengthened. Side rods as long as nine feet came into use, but the increase of grate that resulted proved a short-lived remedy. Then came the practice of sloping the

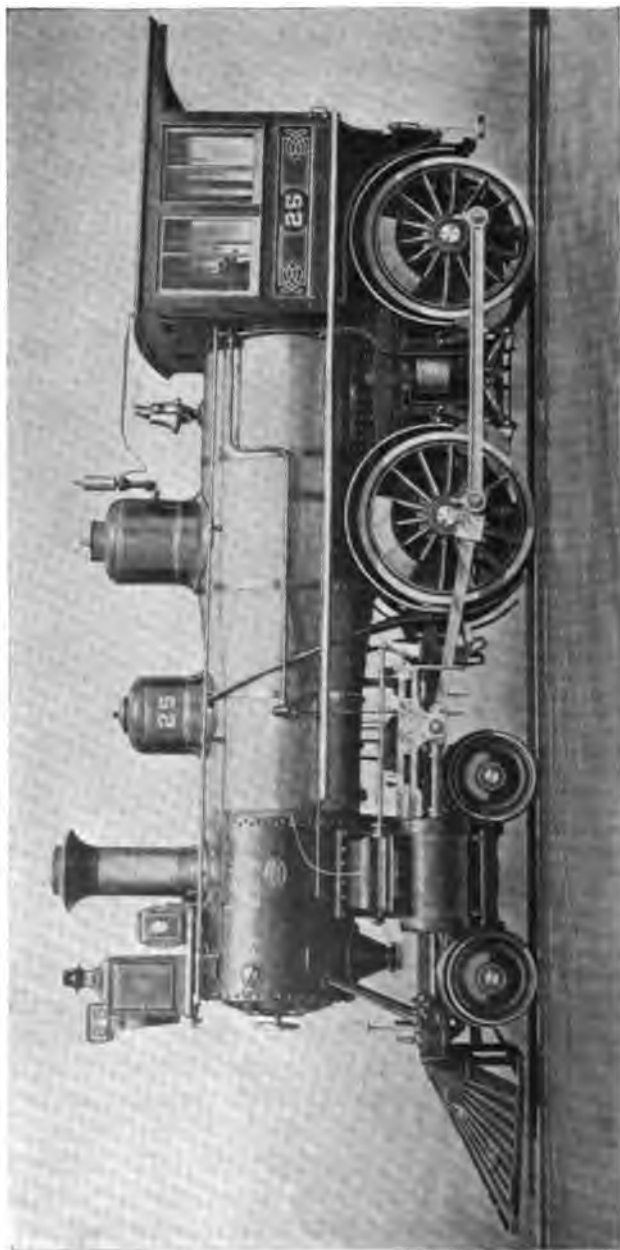

1890. 4-4-0, Still Popular



grate and raising the center line of the boiler. By this means the back of the grate was brought sufficiently high to pass over the rear axle, permitting the fire box to extend back an indefinite distance. This permitted the grate to be made as long as it could be fired. Such grates were sometimes made from 9 to 10 feet long, providing an area of about 30 square feet. That kind of fire box was always very unpopular with the enginemen and was wasteful of coal.

### Fire Boxes Above Frames.

In carrying on experiments with grates large enough to burn anthracite coal, James Millholland, about 1855, raised the grates of some engines so that the mud ring rested upon the top of the frames. This increased the grate area about four square feet. When long grates of eighth decade engines had reached the limit, some builder introduced Millholland's plan with 4-4-0 engines. Others followed this lead and the arrangement became popular for a few years and prolonged the utility of the engine so that it continued to haul the principal passenger trains until about 1896. In 1891 William Buchanan, of the New York Central Railroad, co-operating with A. J. Pitkin, manager of the Schenectady Locomotives, brought out an abnormally large 4-4-0 locomotive to haul the heavy express trains. It was numbered 870, had cylinders 19 x 24 inches, driving wheels 78 inches diameter, weighed 120,000 pounds, of which 80,000 pounds were upon the drivers. The fire box, set above the frames, provided grate area which was 96 inches long and  $40\frac{7}{8}$  inches wide, a total of 27.3 square feet. There were 268 2-inch tubes 12 feet long which, with fire-box area, provided 1,851.5 square feet of heating surface.

That form of engine was largely copied and made heavier, one group having been made with the engine a total weight of 136,000 pounds with 90,000 pounds on the drivers. This was passing the limit, for 22,500 pounds weight pressing the rail beneath each wheel was more than steel rails or steel tires could endure in a fast running locomotive.

Much greater weight per wheel is used on some roads today, but the purchasers of locomotives are less solicitous concerning the well-being of the track than they were in 1900.

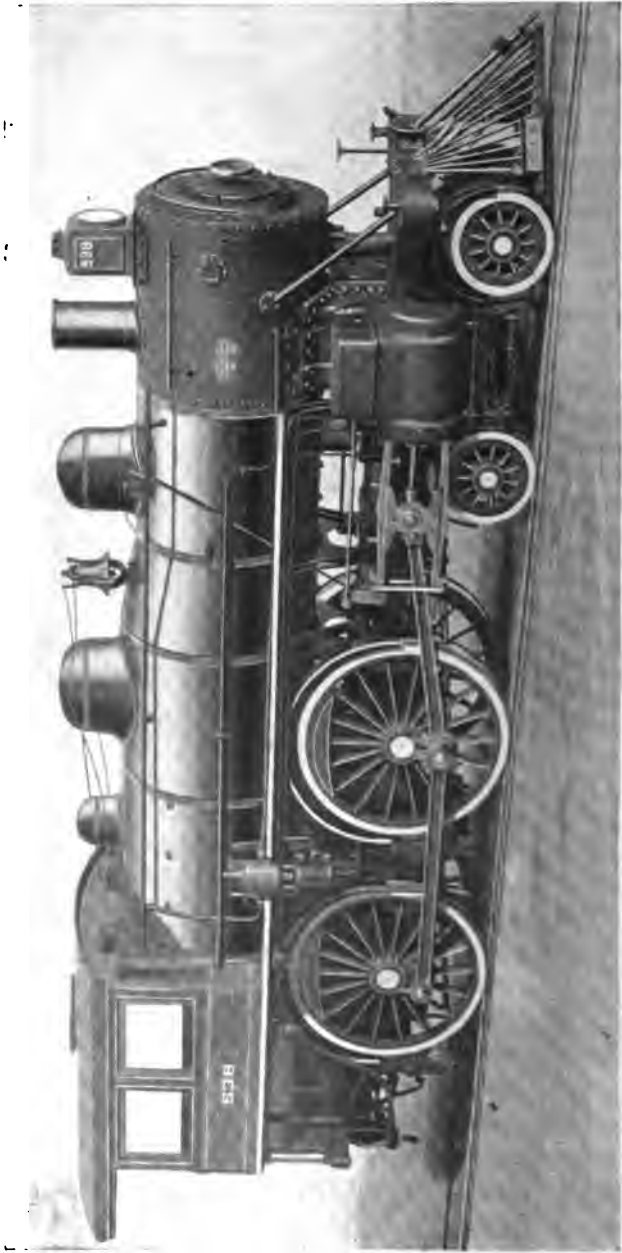

1900. Last Size of Its Type

### Finding Substitutes.

Long before the "American" locomotive had reached its safe weight for heavy express trains, railroad companies had proceeded to differentiate the power for passenger and freight service. The mountain and mineral railroads had developed heavy motive power and ten wheelers, mogul and consolidation locomotives, were familiar to all railroad officials that were beginning to find the eight wheel engine too light for the increasing weight of cars whose carrying capacity was made greater, year by year, as traffic augmented. About 1885 the eight-wheel engine was rapidly disappearing from the front of freight trains, even on level railroads, and its place was taken by ten-wheel (4-6-0) and mogul engines (2-6-0). Ten-wheel engines were decidedly in favor, probably because they had such a close resemblance to the favorite 4-4-0. In many quarters there was decided prejudice against the mogul on the ground that a pony truck was not so safe in leading the engine as a four-wheel truck. That is contrary to the teachings of experience and of engineering principles. Most ten-wheel engines have the front pair of drivers so far forward that there is very little weight on the four wheel truck, and there is reason for believing that there have been cases where the hind drivers having dropped into a low joint, the back of the engine jerked downward far enough to lift the lightly loaded truck off the track. There have been many mysterious derailments of ten-wheel locomotives that might be easily accounted for on this theory.

### The Wootten and Other Wide Fire Boxes.

In 1877 John E. Wootten introduced the wide fire box extending over the frames and providing all the grate area any locomotive might require. Woottens invention improved on forms previously designed by Colburn and Millholland; but as general manager of the Philadelphia & Reading Railroad he had superior means of pushing the merits of his boiler before the railroad world. The Wootten fire box was used principally for burning fine anthracite; but it was beginning to find favor with railroads using bituminous coal, when, in 1895, a new rival appeared that made very rapid progress into popularity.

This was what became known as the Atlantic type, designed by William P. Hensey, of the Baldwin Locomotive Works. The



**Heavy Fast Express Engine, Designed by W. H. Marshall, Built by Brooks Locomotive Works. Cylinders, 20 X 28 Inches; Drivers, 80 Inches Diameter; Heating Surface, 3,356 Square Feet; Grate Area, 48 Square Feet; Weight of Engine, 190,000 Pounds**

engine was the result of cogitating over the problem of providing more grate area than had been possible with the 4-4-0 pattern. This design of engine permitted the fire box to be extended over the trailing wheels and enabled the grate area to be greatly increased, doubled if necessary. This form of locomotive appears to have proved the most popular type ever produced. It rapidly pushed the 4-4-0 form, long so popular, out of demand, and is now equally in favor in all countries where powerful fast locomotives are required.

### Columbia Type.

Three years before Baldwin Locomotive Works brought out the first Atlantic engine, they built another locomotive, designed also by Mr. Hensey, which was known as the "Columbia" type (2-4-2). That engine permitted the fire box to be extended over the trailing wheels, just as the Atlantic type does, providing unlimited grate area, the same as was afterwards done with the Atlantic type. Somehow the railroad world did not take kindly to the Columbia, probably through the same prejudice that prevails against running moguls on fast passenger trains. Yet, engines called the "Prairie" type (2-6-2), first designed by Waldo H. Marshall, in 1901, for the Lake Shore and Michigan Southern Railway, are becoming highly popular and are ideal motive power for heavy express trains. No fault is found with 2-6-2 engines, but those with 2-4-2 wheel arrangement are not in demand.

The competition in hauling freight at the lowest possible cost has led to the introduction of enormously powerful engines even on level lines. The locomotive weighing over one hundred tons has become common and all sorts of wheel arrangements have been tried.

### Compound Locomotives.

In 1874 Anatole M. Mallet, a French engineer, obtained a patent on a compound locomotive, and the inventor at once proceeded vigorously to push that sort of engine upon the attention of railroad officials, claiming decided economy through the double expansion of the steam. The idea of obtaining double expansion of steam seemed to be alluring to the railway engineers of the continent of Europe, and compound locomotives were soon operating on a great many railways. The



**Mallet Articulated Compound for the Great Northern. G. H. Emerson, Superintendent of Motive Power. Baldwin Locomotive Works, Builders. Cylinders, 21 $\frac{1}{2}$  and 33 X 32 Inches; Drivers, 55 Inches; Heating Surface, 5,658 Square Feet; Weight of Engine, 355,000 Pounds (Estimated)**

British railways did not become enthusiastic about compounds, with the exception of the London & Northwestern, which, led by the mechanical engineer of the company, F. W. Webb, had a great many three cylinder compounds put in service. Two or three other British railways tried a few compounds, but that form of engine was by no means popular.

### Vauclain Compound.

In 1889 a patent was granted to Samuel M. Vauclain, of Philadelphia, for a four-cylinder compound locomotive which had two cylinders on each side of the smoke box, both pistons connecting with one cross head. The ratio of cylinder volume is as near 3 to 1 as convenient dimensions will allow. The low pressure cylinder is placed either above or below the high pressure, according to designs of the engine.

The cylinders are cast in one piece with the valve chamber and saddle, the cylinders being in the same vertical plane as close together as they can be put with adequate walls between them.

As the steam chest must have the necessary steam passages cast in it, and dressed accurately to the required sizes, the main passages in the cylinder castings leading thereto are cast wider than the finished fronts. The steam chest is bored out sufficiently larger than the diameter of the valve to permit the use of a hard cast-iron bushing. This bushing is forced into the steam-chest under such pressure as to prevent the escape of steam from one steam passage to another, except by the action of the valve.

As the steam supply for the high pressure cylinder enters the chest at both ends the valve is in perfect balance, except the slight variation caused by the area of the valve stem at the back end.

The first of these engines was built in 1889 by the Baldwin Locomotive Works and three the following year. Since that time over 2,000 Vauclain compounds have been placed into service and to-day they are running in every part of the world.

Albert J. Pitkin, of Schenectady, received, in 1889, a patent on the intercepting valve for a two-cylinder compound. In the first form of Pitkin compound the intercepting valve was so operated that the engine started simple but became automatically compound as soon as the receiver pressure reached a cer-

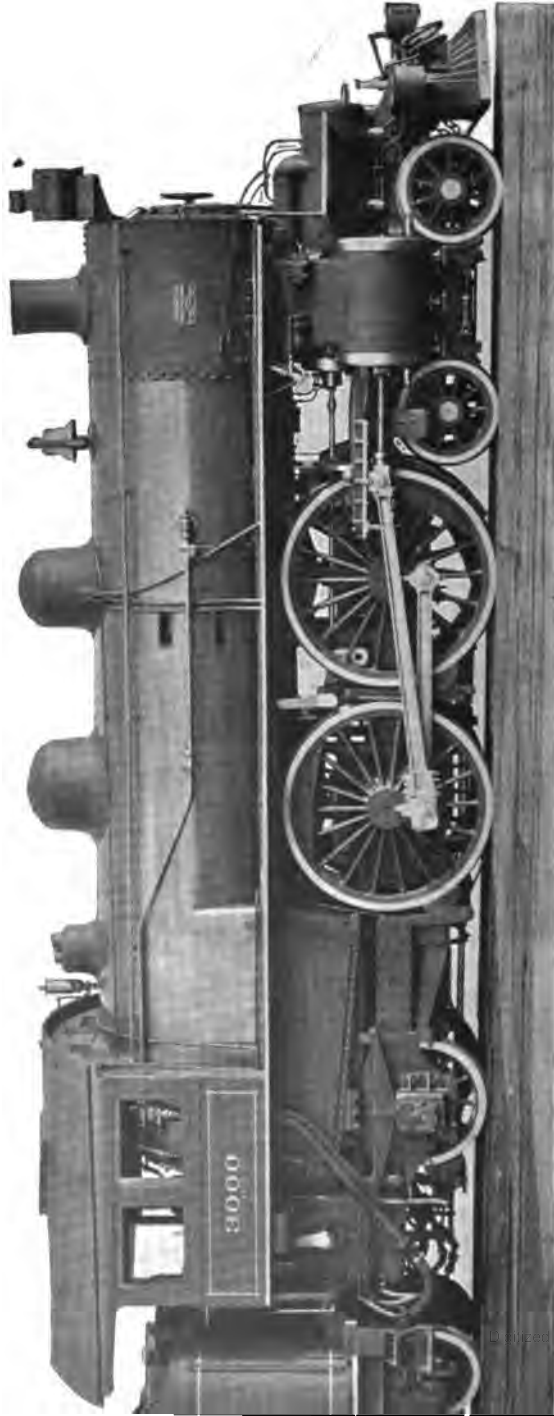

**Four-Cylinder, Balanced, Divided Compound Locomotive, New York Central & Hudson River Railroad. J. F. Deems, General Superintendent Motive Power. American Locomotive Company, Schenectady Works, Builders. Cylinders, 15½ and 26 X 26 Inches; Weight, 200,000 pounds; Heating Surface, 3,446 Square Feet; Grate Area, 50.3 Square Feet**



tain point. This was afterwards changed so that the engineer can keep the engine working simple in starting or on heavy grades, which has enhanced the capacity of the engine for train hauling. One of the first Pitkin compounds which was built in the latter part of 1889 was purchased by the Michigan Centfal Railroad and was in every respect the same as a class of ten-wheelers belonging to the company, with the exception of the compound features. In co-operation with Mr. William Rosing, then mechanical engineer on the Illinois Central Railroad, I was permitted, early in 1890, to carry out a series of comparative tests between this compound and one of the simple engines of the same class. Special road tests of locomotives are far from being satisfactory for the variables get beyond record. As near as could be estimated the compound did the same work as the simple engine on 18 per cent. less coal.

The Pitkin compound has maintained a good reputation all these years and there are many of them now in use.

The Richmond Locomotive Works build a two-cylinder compound on the Mellin system, which has the intercepting valve on the low pressure side and is moved automatically by receiver pressure. The Richmond compound is very easy to maintain and it probably has as many friends as any compound at work on this continent.

About the year 1878 four-cylinder compound locomotives designed by Alfred G. De Glehn for the Northern Railway of France, began to attract the attention of the engineering world, owing to claims made for unusual economy of steam, for remarkably smooth riding and harmonious operating. The claim was advanced that the arrangement of working parts made a perfectly balanced locomotive, which was not the exact truth but the engines advanced rapidly into popularity for, by the year 1904, over 1,500 of them were in service in France, while the railways on Continental Europe nearly all were experimenting with that form of motive power.

The reputation of that type of locomotive had been so warmly advocated in the United States, that in 1904 the Pennsylvania Railroad Company, always in the lead seeking for improvements, imported one of the engines built in France for the purpose of demonstrating its real value. The experience does not appear to have been entirely satisfactory for the railroad company are not increasing their equipment of compound locomotives.

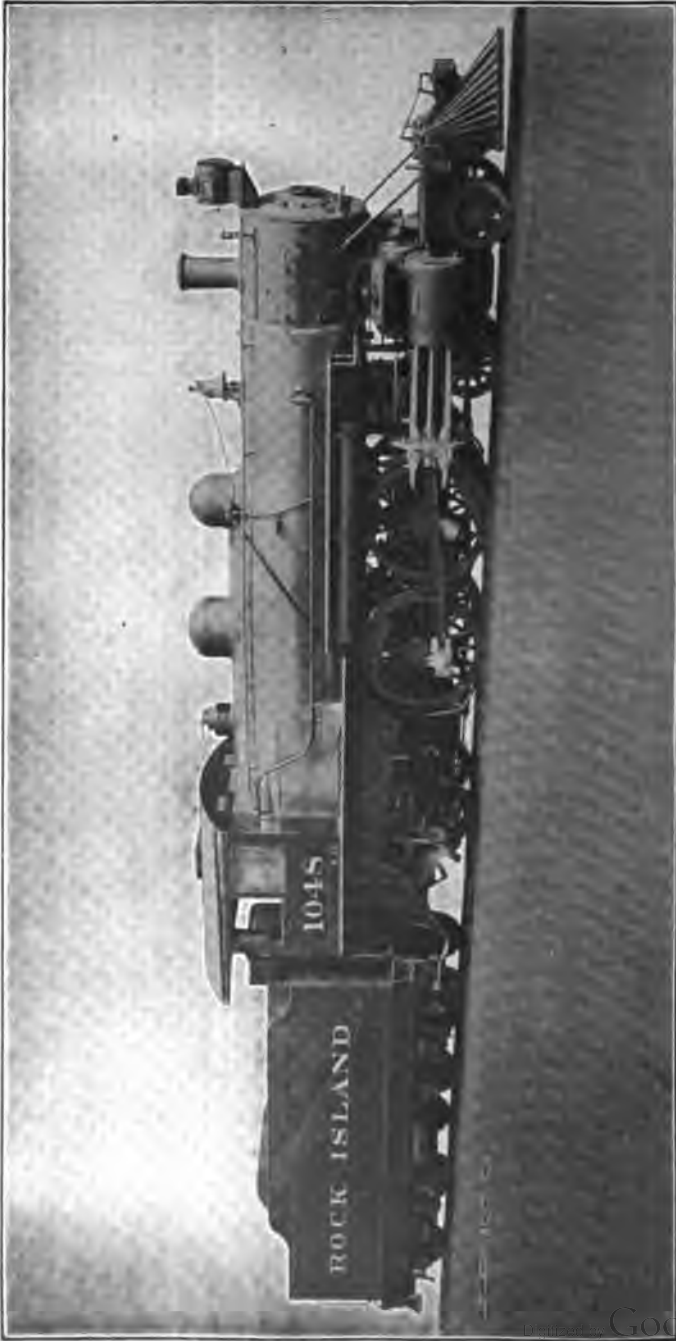

4-4-2 For the Chicago, Rock Island & Pacific. T. S. Lloyd, General Superintendent of Motive Power. Baldwin Locomotive Works, Builders. Cylinders, 15 and 25 X 26 Inches; Drivers, 73 Inches Diameter; Weight, 199,400 Pounds; Heating Surface, 3,015 Square Feet; Grate Area, 50 Square Feet

### Vauclain's Balanced Compound.

In 1904 a patent was granted to Samuel M. Vauclain for certain improvements on four-cylinder compound locomotives which were applicable principally with the De Glehn type of balanced engine. The valves are so designed that they supply steam to an outside and an inside cylinder. They are of the piston variety, actuated by indirect motion with outside admission for the high pressure cylinders. The high pressure exhaust passes into the interior of the valve at one side and finds its way to two ports or openings in the other side which feed the low pressure cylinders, and the low pressure exhaust passes through the valve to the atmosphere. The horizontal center lines of the high and low pressure cylinders coincide, and the valve is placed in such a way that when steam leaves the high pressure cylinder it passes up to the valve and down to the low pressure cylinder.

The cylinders and main axles are so arranged that the high pressure pistons drive on the leading axle, which is cranked, the cranks being set on the quarter as usual. The low pressure pistons drive on the outside crank pins of the rear wheels, as is usual with the 4-4-2 type of engine. The low pressure piston rod is longer than usual and it does not go entirely into the cylinder at each stroke. A glance at our half-tone illustration will show the low pressure crosshead apparently near the back end of the guides, while in reality it is in mid stroke. The high pressure piston rod and cross head conform to usual practice. When the outside crank pin on the right side is on the bottom quarter, the inside crank axle pin on the same side is on the top quarter, and allowing for the angularity of the connecting rods in these positions, the pistons will each be about in the mid-stroke position, and as the engine moves forward the pistons on the same side will move in opposite directions. The counterbalances on this engine present an interesting feature, the counterweights on the forward wheels balancing the cranks in the axle.

### Samuel M. Vauclain.

Samuel M. Vauclain, whose name is so intimately connected with the invention of compound locomotives, is one of the ablest men ever connected with the improvement of the locomotive engine. He has a powerful personality that seems to find the most

perplexing problems of engineering, trifles worthy to beguile a leisure hour.

Mr. Vauclain received an admirable railroad mechanical engineering training which developed natural gifts in the lines that move the possessor to do things worthy of the world's regard. At the age of 16 he entered the shops of the Pennsylvania Railroad at Altoona as an apprentice and had his indentures cancelled satisfactorily when he was 21 years old. There is no better training for an ambitious youth, willing to learn the mechanical part of practical railroading, than that enjoyed by the apprentices of



Samuel M. Vauclain

the Pennsylvania Railroad as has been abundantly proved by the numerous graduates of that hard work school, who are holding high positions all over the world to-day. Mr. Vauclain made the best of his opportunities.

Mr. Vauclain worked for the Pennsylvania Railroad in various capacities, always connected with locomotives, and was noted for the thoroughness with which everything was done indicating that his heart was always in his work.

In July, 1883, Mr. Vauclain accepted a position with the Baldwin Locomotive works as foreman of one of the departments

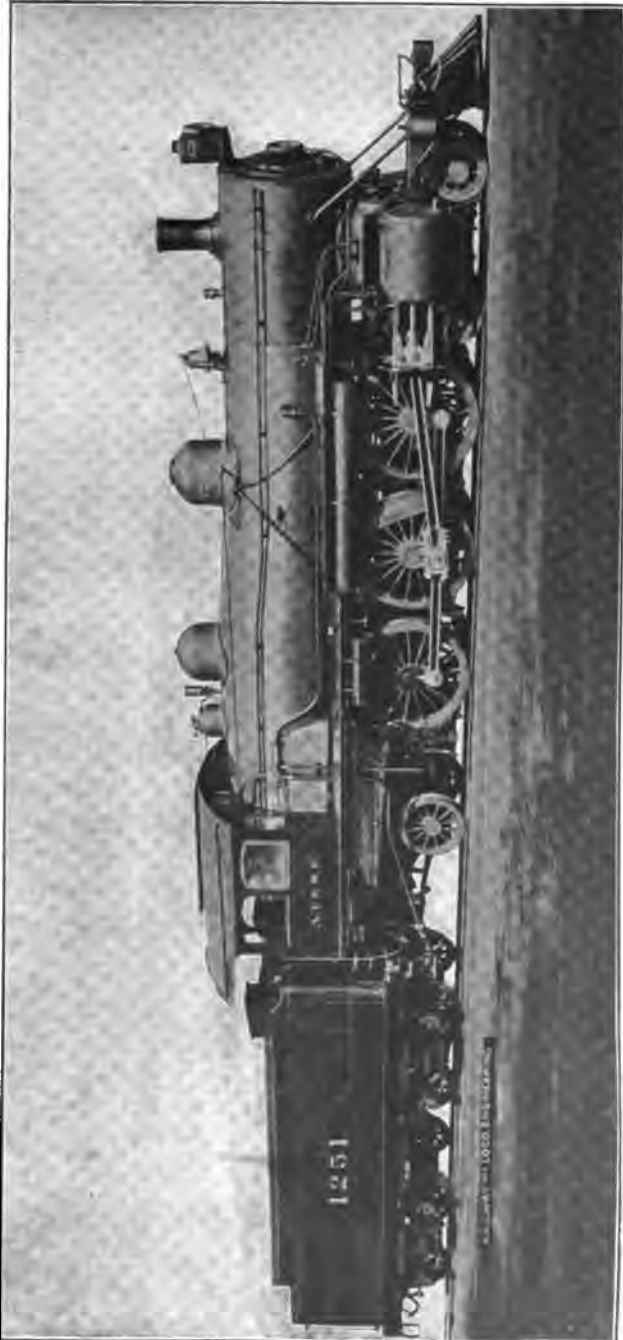

4-6-2 For the Atchison, Topeka & Santa Fe. Alfred Lovell, Superintendent of Motive Power. Baldwin Locomotive Works, Builders. Cylinders, 17 and 28 X 28 Inches; Drivers, 73 Inches Diameter; Weight, 226,700 Pounds; Heating Surface, 3,595 Square Feet; Grate Area, 54 Square Feet

which he filled for over two years, when he was put in charge of the machinery of the entire establishment. A little later he was made general superintendent, a position he still holds. Eleven years ago, in 1896, he was taken into the Baldwin Locomotive Works as a partner and no one ever better deserved the good fortune that came to Samuel M. Vauclain.

As general superintendent over these immense works Mr. Vauclain has the power of a monarch and it is wielded with the spirit of giving a square deal to the humblest and highest under his charge. Under his broad kindly management harmony prevails and contentment takes the place of the antagonisms so common in great industrial establishments.

### Cole's Four-Cylinder Balanced Compound.

The American Locomotive Company are building four cylinder balanced compounds from designs made by Francis J. Cole, mechanical engineer of the company. The valve gear is of the ordinary indirect type and the valves, of which there are four, one for each cylinder, are all outside admission piston valves. Two are on one stem on one side and two are on another stem on the other side, making a tandem arrangement. The eccentrics are on the axle of the rear drivers. The two low pressure cylinders are placed in the usual position outside the frames; their pistons apply force to the rear pair of drivers, in the usual way. The high pressure cylinders are placed between the frames, 46 inches ahead of the low pressure cylinders, and their pistons drive on the forward or crank axle. These high pressure cylinders, in fact, lie out practically on the front foot plate.

The cranks and crank pins are arranged so as to make a perfect balance in the working parts. When the low pressure piston on the right side is at the front end of the cylinder, the high pressure piston on the same side is at the back end of its cylinder and the left main crank pin is on its bottom quarter and the left crank on the forward axle is at its highest point. The counterbalancing of the wheels is interesting. The rear drivers are counterbalanced in the usual way, but the counterbalancing of the forward driving wheels is a compromise, if one may say so, which takes into account the forward end of the side rod and the heavy connecting rod which is attached to the crank axle.

The arrangement of the guide bars of the high pressure cylinders is novel. The guides and cross-heads for all cylinders are alike, but the high pressure guides are bolted to the under-side of the valve chamber of the low pressure cylinder. The cross-head is a modification of the Laird type, but is arranged so that the wearing surfaces are all enclosed and covered up so that they are thus kept free from dust and grit.

This description applies to the first Cole balanced compound locomotive, built in 1904, but various changes have been made on the engine since that time, among them the introduction of the Walschaert valve motion. This change was made to enable the builders to introduce strong cross-frame bracing.

### **Present Trend of Locomotive Building.**

The trend of locomotive building in 1907 is towards enormously heavy engines, large consolidation locomotives becoming common on perfectly level railroads. For operating mountain railroads the Mallet articulated double ended compound described in Chapter XIII is growing into favor. The talk of widening the prevailing track gauge is more than an idle rumor, and it may be that modifications of such locomotives as the Mallet forms will come to be employed in regular train service on a wider track, when cars are made sufficiently strong to resist the shocks of impact and the rails are made sufficiently tough to endure the pressure of enormous concentrated weight.

### **The Compound Locomotive Situation.**

The four-cylinder balanced compound is decidedly in favor at present, next to the single expansion engine, which never has lost its popularity. There appears to have been a wave of prejudice against compound locomotives sweeping over the United States of late and old forms are falling out of favor. Orders for the first form of four-cylinder Vaucrain compound have almost ceased, but about six per cent. of the locomotives built by the Baldwin Locomotive Works are Vaucrain's four-cylinder balanced compound. The same condition of affairs exist in the works controlled by the American Locomotive Company where the two-cylinder or cross compound is overshadowed by the magnitude of the four-cylinder balanced compound.

The limited movement towards the use of compound locomotives that existed in the British Isles for a few years seems to

have waned, blighted in its early bloom, and some of the railway companies are reported as having changed their compounds into simple engines.

Strange as it may appear after noting American and British tendencies, the railway companies of Continental Europe are rapidly extending the use of compound locomotives and some railway companies build nothing else. Why, a certain type of locomotive may be popular in one country and discredited in another, may be due to the manner in which they are treated. The treatment by most American railroads of their freight power is simply brutal. In the British Isles the railway motive power is petted. On Continental railways fair mileage is demanded from locomotives well cared for.

### **Our Debt of Gratitude.**

The men who have labored so successfully to develop the locomotive engine, are deserving of our warmest praise and admiration. We have seen the engine grow in size and power, with details made better to keep pace with the increasing magnitude of the structure. It came into use a crude apparatus of wood and iron, without comeliness, elemental in form, material and in operation; but the hands of master mechanics by degrees converted it into the shape that required merely additions in dimensions and weight to produce the locomotive of to-day.

The period of first growth was also a period of refinement. The mechanism was adjusted so well to meet the stresses and strains of service that breakage became rare. Wooden beams gave place to iron bars and later to cast steel frames. Wrought iron and even cast iron tires were displaced by most reliable steel. Copper and iron fire-boxes were pushed out of use by mild steel and iron boiler plate was relinquished because steel was found stronger and more reliable. Cast iron driving wheel centers that performed their turn admirably are disappearing under the competition of steel castings that keep intact. Many other details have been improved.

### **Efficiency and Effectiveness.**

When the necessity for making the locomotive economical in the use of steam became apparent, valve lap was applied to produce automatic steam expansion and the valve motion was sufficiently developed to provide good steam distribution. Under



this treatment the locomotive became the most economical steam engine in use, except condensing engines and those of the automatic cut-off variety. The lines of development worked since 1876 have not increased the efficiency of the engine. The world has frequently seen the village church expand into an imposing cathedral. The big building was magnificent and appealed to the sense of wonder; but it seldom possessed the same saving influence of the smaller edifice. Growth in magnitude was not accompanied by growth in grace. The immense aggregation of iron and steel forming the modern locomotive is impressive to the eye, but is not so efficient as the small types passing away.

The modern locomotive is superior to old forms merely through the great power that enables it to decrease the pay roll of train men engaged in the movement of a given volume of freight. Something is also saved in the dead weight of the motive power when the movement of hundreds of tons of train weight is considered. But the engine that hauls a train of 4,000 tons is not so efficient *per se* as that which used to be rated to haul 500 tons.

Still the modern locomotive has enabled the railroads of North America to haul passengers and freight at lower cost than the locomotives of any other country. But the engine is susceptible to much improvement on the lines of increased efficiency.

THE END.

# INDEX.

GENERAL.	
Accident, Angola	522
New Hamburg	523
Norwalk Draw Bridge	522
Port Jervis	522
Revere	531
Accidents, Immunity from, During	516
First Railroad Decade	521
Increase of Train	521
Preventable Train	2
Aeolipile, Whirling	531
Air Brake, Automatic	538
Cause of Failure	530
Efficiency of	530
First	541
Home of the	528
Invented	526 to 542
Westinghouse	5
Air Pressure, Raising Water by	52
Allen, Horatio, Chief Engineer	54
On Locomotives	53
Recommends Locomotives	16
Anderson, Prof. John, On Railways	257
Applan Way, Proposed	196, 196, 198
Baldwin, Double Ender	134
Improvement on Boilers	133
Improves Valve Motion	133
Opposes Link Motion	61
Baltimore and Ohio, Development of	8
Beighton's, Henry—Work on Newcomen's Steam Engine	73
Bell, J. Snowden, On Development of Locomotive	203
Bell Rope, Introduction of	24
Blackett's, Scientific Traction Tests	69
Boiler, Atlantic	57
"Best Friend" Explodes	67
Cheese	378
Cornish	377
Cylindrical	378
Development of the Locomotive	382
Dripps	376
Globular	68
Improvement on Cheese	388
Modern	92
Monster	385
Nichols' Novelty	241
Rogers Applies Wagon Top	387
Vanderbilt	381
Vertical Locomotive	134
Boilers, Baldwin's Improvements on	376
Consideration of the Designers	70
Objections to Vertical	66
Popularity of Vertical	389
Boilers Illustrated, Baldwin's Latest	383
Belpaire	384
Bury's	382
Dripps	381
Ericsson's "Novelty"	388
Hackworth's Return Flue	385
Modern Locomotive	379
Nichols' "Novelty"	390
Seguin's Multitubular	377
Stephenson's "Rocket"	387
Trevithick's Return Flue	402
Vanderbilt's Corrugated Furnace	390
Boilers, Smoke Preventing, Illustrated	405
Baldwin's	392
Beattie's	405
Boardman's	392
Cudworth's	404
Dimpfel's	400
Eaton's	391-393
McConnell's	407
McQueen's	408
Norris	406
Phleger's	401
Rogers'	85
Bordentown, Facts About	170
Boston, Favors Railroad Building	172
Primitive Railroad Service in	530
Brake, First Air	523
Loughridge Chain	535
Requirement of Good	525
Steam, Blamed for Boiler Explosion	524
Unlucky Steam	532
Vacuum	526, 542
Westinghouse Air	516
Brakes, Bumper	534
Chain	515
Common Hand	517
Connecting on both Trucks	520
Difficult Functions Performed by	535
Freight Train	516
Importance of, in America	536
Master Car Builders on	513
Patented	513
Stephenson's Steam	518
Stevens and Hodge	521
Urgent Need of Continuous	203
Brick Arch, Invention of	41
Buchanan, Wm., Locomotive Designer	104
Builders, Rivalry Among Locomotive	537
Burlington, Brake Tests at	33
Bury, First, Locomotive	145
Cab, First	609 to 629
Canada, Railway Development in	163
Canal, Agitation in Favor of	50
Chesapeake and Ohio	50
Erie	267
Preferred to a Highway	51
Cars, Horse and Wind	164
Charters, Opposed to Granting Railroad	362
Chicago Established	65
Childs, Ezekiel, An Inventive Genius	64
Clark, David, Locomotive Builder	280
Coal, Burning Anthracite	8
Cock, Two Way and Four Way	91
Combustion Chamber, First Use of	43
Compound Locomotives, De Glehn	196
Mallet's	197
Schenectady Mallet	655
Vauclain	42
Webb's	43
Worsdell's	61
Cooper, Peter, Work of	64
Costell, Stacey, Locomotive Builder	35
Counterbalancing of Driving Wheels	88
Cow Catcher, First	12
Cugnot, Invents First Steam Carriage	359, 360
Cuyahoga Locomotive	481
Curiosities and Freaks in Locomotive Design	6
Cylinder, and Piston	34
Diversity in Location of	631
Cylinders, Size of	69
Davis, Phineas, First Railroad Martyr	64
Locomotive Builder	64

Detmold, C. E., Invents Horse Locomotive	51
Digester, Papin's	6
Dotterer, Thos., Rebuilds "Best Friend"	58
Dripps, Isaac, Pioneer Master Mechanic	86
Driving Wheels, Counterbalancing of	35
Large	97, 98
Dubs and Company, Locomotive Builders	38
Edgeworth, Richard, Proposes Railway Passenger Trains	15
Engine, Columbia	18
Description of Cugnot's	12
Huyghen's Gas	5
Improving Newcomen's Steam	8
Invention of Steam	1
Newcomen's Atmospheric	6
Practical High Pressure	11
Engineers, Famous Galena	370
Railroad, Chapter on	256
Erle, Curiousities of Location	272
First Engines for	263
Mascot	271
Motive Power of	266, 277
Strikes on	275
Variety of, Locomotives	265
Evans, Oliver, Invents High Pressure Steam Engine	17, 45
Runs Scow Through Streets of Philadelphia by Steam	19
Work Done by	17
Experiment, Period of	28
Fairlie's Double Ender	193
Fire-boxes, Clarke's Smoke Preventing	398
Copper	135
Craig's Smoke Preventing	396
Debranch Smoke Preventing	394, 395
Head's Smoke Preventing	399
Jeffreys' Smoke Preventing	297
Origin of Wide	305
Steel First Tried for	135
Frame, The Bar	106
Freaks and Curiosities in Locomotive Design	481
Gas Engine, Huyghen's	5
Gauge, Establishing Track	261
Grade Climbing	131
Grades, Special Locomotives for	129
Great Britain, Development of Locomotives in	32
Hackworth, Timothy, Locomotive Designer	37
Harriman, E. H., Proposes Six-Foot Gauge	329
Hedley's, Wm., "Puffing Billy"	24
Hero of Alexandria Describes First Steam Engine	2
Hill, John A., Finds Picture of Monster Locomotive	93
Hughitt, Marvin, Railroad Manager	362
Illustrations, Miscellaneous, Atlantic Boiler	69
Baldwin's Improved Driving Wheels	126
Baldwin's Stationary Engine	114
Branca's Steam Turbine	4
Bridge, Old Victoria	619
Cheese Boiler	67
Clarke's Independent Cut Off	319
Cugnot's Steam Carriage	13
Evans' Orukot Amphibolis	19
Evans' Steam Engine	18
Huyghen's Gas Engine	5
Improvement on Cheese Boiler	68
Injector, Little Giant	583
Injector, Nathan's Simplex	582
Injector, Sellers'	580
Leupold's Steam Engine	12
Murdock's Model Locomotive	14
Newcomen's Atmospheric Engine	7
Passaic Falls	229
Remains of Portage Railroad	344
Rogers Locomotive Works	231, 233

Illustrations, Miscellaneous—	
Track Where Trevithick Locomotive Ran	22
Valve Motion of Stevens Crampton	36
Watts Steam Engine	10
Westinghouse Air Brake Officials	543
Westinghouse Air Brake Works	541
Whirling Aeolipile	3
Inclined Plane, Mauch Chunk	313
Philadelphia and Columbia	101
Interchangeability of Parts	128
Injector, Invention of the	578
Little Giant	583
Nathan's Simplex	581
Sellers'	579
Inventor, The Enterprising	481
New England, Favors Canals	168
First Railroad Opened in	171
Locomotive Building in	177
Slow to Build Railroads	163
New Jersey, Convenient Manufacturing Position	229
First Railroad in	85
Locomotives Built in	249
Papin, Denys, Work of	6
Passes, Origin of Railroad	109
Paterson, As Industrial Center	231
Pennsylvania Railroad, Buys State Road	348
First Links of	84
Organization of	345
Petsch, Julius D., First Master Mechanist	58
Philadelphia, Mechanic Arts in	114
Piston and Cylinder	6
Planet Type Locomotive	23
Pony Truck, Improving	363
Potter, Humphrey, Invents the First Self-Acting Valve Mechanism	8

## LOCOMOTIVE BUILDERS.

Baldwin, Matthais W.	114
Boyd, Seth	250
Breeze, Kneeland and Company	251
Canadian	622
Campbell, John	325
Clark, David	324
Costell, Stacey	113
Danforth, Cooke and Company	247
Davis and Gartner	112
Garrett and Eastwick	142
Good, James, Toronto	613
Hinkley and Drury	178
Hoffecker	317
In New England	179
James, Wm. T.	66, 112
Locks and Canals	179
Long and Norris	116
Mason, Wm.	183
McHenry, James	252
McKay, Nathaniel	253
New Jersey Locomotive and Machine Works	246
Niles	360
Norris, Edward S.	97
Norris, Richard, and Sons, Locomotive Builders	94
Paul and Briggs	232
Pioneer	224, 227
Rivalry Among	104
Rogers, Ketchum and Grosvenor	233
Sellers, Coleman, and Son	137
Swinburne	246
Swinburne, Smith and Company	245
Trenton Locomotive Works	254
Watch Makers as	113
West Point Foundry	111
MISCELLANEOUS LOCOMOTIVE NOTES.	
Baltimore and Ohio Eight Wheel Connected	74, 75, 77, 79, 80, 81, 82
Blackhawk	307
Boston and Worcester Express	213

Locomotive—	Trenton's "Belvidere".....	255
Building in the United States.....	Vermont Central, Old.....	259
Childs' Rotary.....	Victory of a Cuyahoga.....	269
Competitions at Rainhill.....	Vauclain, Compounds.....	255
Compound.....	Winan's "Atlanta".....	2
Balanced.....	Winan's "Crab".....	71
Costell.....	Winan's Vertical Boiler Engine for	
Cylinders, Oscillating.....	Western Railroad.....	297
Development of Eight Wheel Con-	York.....	64
nected.....	Locomotives, Americans Ready to	
De Witt Clinton.....	Build.....	29
Driving Wheels, Counterbalancing.....	Building, for Fun.....	184
Early Northern of France Freight,	Canadian, 612 613, 615, 617, 618, 621,	
191, 192	623, 624, 625, 626, 627, 628, 629	
Eddy, Wilson—Improves.....	Compounds, in Great Britain.....	2
Efficiency of Modern.....	De Glehn.....	2
Fire Box, Above Frames.....	Development of, in Great Britain.....	22
Fire Box, Wide.....	Development of Multi-Coupled.....	223
Fire Box, Wootten.....	Diversity Among Pioneers.....	119
First Equalizer.....	Early Four Cylinder.....	217
First Mogul.....	French Novelties.....	299
First Practical.....	Grand Trunk, Early, 612, 615, 617, 618, 620	
Four Wheel Connected.....	Galena & Chicago Union.....	263
Freaks and Curiosities in, Design.....	Grate Area.....	623
Garrett and Eastwick.....	Heating Surface.....	623
Gowan and Marks.....	Hill Climbing.....	328
Grade Climbing.....	Homely.....	182
Grasshopper Type of.....	In South Kensington Museum.....	26
Griggs' Smokestack.....	Large Driving Wheel.....	96
Growth of Building.....	Low Center of Gravity.....	494
Hackworth's "Royal George".....	Progress of Locomotive Building.....	22
Harrison's Patent.....	Puffing Billy, Built by Hedley.....	24
Hercules.....	Modern.....	630-661
Hinkley's Inside Connected.....	Multi-Coupled.....	326
Johnson, Geo. W., Pioneer Engineer.....	Norris and Mason's.....	513
James.....	Ornamentation of.....	182
Jervis Truck Engine.....	Political Effect of Heavy.....	328
John Bull.....	Powerful Austrian.....	199
Johnson's.....	Powerful French.....	191
Kirtley, Matthew, Locomotive Superin-	Proportions of.....	629
tendent.....	Scottish in Canada.....	612
Latrobe, Benjamin H., Chief Engineer.....	Special Forms of.....	544
Leupold, Work by.....	Stroke, Long and Short.....	631
Lewis, Enoch, First S. M. P. Pa.	Tank.....	545
R. R.....	Varieties of Design.....	29
Link Motion, Baldwin Applies.....	Webb's Compound.....	42
Baldwin Opposes.....	Worsdell's Compound.....	42
Introduced by Rogers.....		
Littleton, A. S., Article from.....	LOCOMOTIVES ILLUSTRATED.	
Locomotive Building in New England.....	Adams Express and Car.....	545
179	Adams Light Express.....	544
in the United States.....	Allen's Double End.....	53
Long and Norris "Blackhawk".....	American.....	637, 644, 645
Long's First.....	Arbroath and Forfar.....	612
Mallet Type.....	Baldwin's Flexible Double Truck.....	194
Mechanics, Aristocratic British.....	Geared.....	129, 225
Developing American.....	Baldwin's Grade Climbing.....	120
Mason Beautifies the Locomotive.....	Baldwin's "Lancaster".....	193
Master Mechanics Work on Improv-	Baldwin's "Miller".....	69
ing.....	Baldwin's Pusher for the Erie.....	262
Matthews' Eight Wheeler.....	Baldwin's Truck Adhesion.....	522
Merchant Designs First.....	Baltimore and Ohio "Atlanta".....	69
Merits of Grasshopper.....	Baltimore and Ohio Eight Wheel, 74, 77	
Newcomen Invents Atmospheric En-	Baltimore and Ohio Mallet Double	
gine.....	Ender.....	329
Necessity Brought the Locomotive.....	"Best Friend".....	53
Need of the Locomotive.....	Beugnot's.....	191
Operating, Cost of Railroad.....	Beugnot's Heavy.....	192
Power, Favored Animal.....	Blavier's "L'Algie".....	494
Fecularitels of Locomotives.....	Blenkinsop.....	23
Planet Type of.....	Blenkinsop's Cog Rail.....	423
Prize Offered for.....	Blackett's.....	24
Reading's Mark on.....	Boiler Section of Thulle.....	598
Robert Fulton.....	Boston and Worcester Express.....	214
Rogers' "Batavia".....	Boyden's "Orange".....	253
Schonectady's Mallet Compound.....	Brazilian Mountain.....	555
Sellers'.....	Breeze and Kneeland.....	153, 199
South Carolina.....	Brunton's "Traveller".....	411
Stephenson's First.....	Buchanan's First Fast Express.....	162
Stevens' So. Pacific.....	Bury's "Liverpool".....	28
Story of a Chicago Built.....	Bury Rebuilt.....	292
Successful Grade Climbing.....	Bury's Suburban.....	545
Proportions, Table of.....	Cambrian Railway's "Albion".....	497

## Locomotives Illustrated—

Camel .....	79, 80
Campbell's Eight Wheel .....	124
Chicago Northwestern "Pioneer" .....	363
Clark's "Audenried" .....	313
Colburn's Double Boiler .....	494
Colburn's "Lehigh" .....	304
Columbia .....	649
Compound, Balanced .....	652, 664, 657
Compound, Balanced, Coles .....	653
Cooper's, Peter .....	63
Crampton's "Liverpool" .....	496
Cuyahoga's "Louisville" .....	359
Danforth and Cooke of 1853 .....	243
Danforth and Cooke of 1868 .....	250
Davenport .....	570
Davis and Gartner's "York" .....	64
Detroit's "Persian" .....	369
De Witt Clinton .....	151
Eddy's "Addison Gilmore" .....	306
Eight-Wheel Puffing Billy .....	326
Engerth's .....	190
Engerth's Heavy .....	191
Erle's "H. G. Brooks" .....	275
Erle's "Orange" .....	269
Fairlie's Double End .....	139, 194
First Camel .....	79
First Elevated Railroad .....	549
Fontaine .....	490
Forney .....	550, 552
Forrester's .....	34
Four Wheel Connected .....	41
French Double End .....	193
French Experiment .....	504
Galloway's "Caledonian" .....	483
Garrett and Eastwick's .....	143, 147
Garrett and Eastwick's Mogul .....	146
Governor Bradford .....	212
Gowan and Marx .....	144
Great Western's Ten-Foot Wheel .....	495
Grew's Ice .....	507
Grice and Long .....	313
Griggs' .....	201
Growth of the Tank .....	547
Harrison's "Hurricane" .....	498
Harrison's "Thunderer" .....	489
Haswell's "Duplex" .....	492
Hedley's "Puffing Billy" .....	26
Hellman's Electric .....	500
Hinkley's Eight Wheeler .....	108
Hinkley's "Lion" .....	179
Hinkley's "Massachusetts" .....	211
Hoffecker's 4-8-0 .....	317
Holman .....	491
Horse .....	51
Hudson's Suburban .....	241
Illinois Central's "Mississippi" .....	373
James' Link Motion .....	111
Jervis' "Brother Jonathan" .....	153
Jervis' "Davy Crockett" .....	155
John Bull .....	84
Johnstone's Double End Compound .....	505
Joy's "Jenny Lind" .....	35
Kirtley's Goods .....	40
Lackawanna's "Anthracite" .....	303
Lackawanna's First Ten Wheeler .....	299
Lackawanna's "Investigator" .....	306
Lackawanna's Second Passenger En- gine .....	297
"Lady of the Lake" .....	37
Lafayette .....	107
Last of the Camels .....	80
Latest Baltimore and Ohio, 2-8-0 .....	52
Lowell .....	178
Mallet's Articulated .....	195, 650
Mac's Double End .....	185
Mason's Double Truck .....	183
Mason's "James Guthrie" .....	182
Mason's "Old Colony" .....	188
Mason's "Saxon" .....	187
McConnell's "Bloomers" .....	36
McIntosh's "Dunallstair" .....	43
Mercury .....	145
Mitchell's "Bee" .....	316

## Locomotives Illustrated—

Mitchell's "Consolidation" .....	315
Millholland's "Hiawatha" .....	292
Millholland's "Illinois" .....	290
Millholland's "Pawnee" .....	289
Millholland's "Philadelphia" .....	288
Millholland's Twelve Wheel Con- nected .....	293
Mogul, Early .....	640, 641
Mohawk and Hudson .....	156, 158, 160
Monster .....	90, 91
Morris & Essex .....	293
Mud Digger .....	74
Newcastle Company's "Delaware" .....	371
Nichols' "Novelty" .....	284
Niles .....	361
Norris Pioneer .....	221
Norris' "Chesapeake" .....	333
Norris' "England" .....	117
Norris' "Lafayette" .....	107
Norris' Last .....	633
Norris' "Lightning" .....	97
Norris' Septimus, Ten Wheeler .....	337
Norris' "Washington" .....	105
Norris' "Wyoming" .....	309
Norris 1840 .....	630
Norris 1860 .....	633, 643
Old Colony Patuxet .....	203
Old Cuban .....	132
Old Ironsides .....	123
Old Lowell .....	178
Old Taunton .....	208
Oldest in the World .....	508, 509, 510
Oscillating Cylinder .....	511
Pacific Coast Pioneer .....	638, 642
Pennsylvania Pioneers .....	337-356
Perkins' Eight Wheel .....	81
Petlet's .....	191
Petlet's Double End .....	193
Philadelphia and Reading "Frank- lin" .....	294
Phoenix .....	68
Pioneer, Chicago North Western .....	363
Pittsburgh Freak .....	506
Planet .....	32
Porter .....	556 to 560-564
Prairie, Marshall's .....	648
Raub's Central Power .....	498
Rebuilt Brookline .....	202
Rebuilt Monster .....	93
Recent Shay .....	563
Riggenbach Rack Rail .....	554
Robert's "Experiment" .....	494
Rogers' "Batavia" .....	236
Rogers' First Eight Wheel .....	239
Rogers' First for Erie .....	263
Rogers' "Hackensack" .....	273
Rogers' Improved .....	243
Rogers' "Sandusky" .....	234
Rogers' "Stockbridge" .....	233
Rogers' Ten Wheeler for Erie .....	265
Rogers' "Victory" .....	240
"Royal George" .....	38
Saddle Tank Suburban, Erie .....	548
Schenectady's Mallet for Erie .....	197
Section of Crampton .....	95
Sellers' Hill Climbing .....	334
Shaw Four Cylinder Balanced .....	493
Southern Pacific with Stevens' Valve Motion .....	639
Stephenson's Goods .....	39
Stephenson's "Locomotion" .....	27
Stephenson's "Rocket" .....	30
Stephenson's Three Cylinder .....	497
Stevens' Crampton .....	94, 631
Stirling's "Bogie" .....	42
Stourbridge's "Lion" .....	48
Strong's "Duplex" .....	320
Stroudley's "Gladstone" .....	40
Sussex Railroad's "Governor Haines," Taunton, Old .....	301
Thule High Speed .....	626
Toleman, James .....	498

Locomotives—	
Trenton	255
Trevithick's "Cornwall"	496
Trevithick's First	21
Vermont Central	209
Vulcan Iron Works	570
"West Point"	55
Wilmarth's "Shanghai"	271
Winan's "Carbon"	302
Winan's "Crab"	70
Winan's Eight Wheeler	207
Winan's High Speed	98

## PERSONAL.

Allen, Horatio	49, 59, 116, 152
Baldwin, Matthias W.	59, 113, 114, 122
Bell, J. Snowden	73
Blackett, Christopher	24
Blenkinsop J.	23
Blood, Aretas	213
Bonaparte, Jos.	85
Boyden, Seth	250
Brandt, John	106, 139, 246, 263, 304
Brooks, H. G.	277
Buchanan, Wm.	41
Bullock, W. H.	219
Bury, Edward	33
Cameron, James	139
Cameron, Hon. Simon	139
Campbell, Henry R.	128, 145
Carnegie, Andrew	24
Childs, Ezekiel	65
Clark, John T.	156
Clark, John	247
Clinton, DeWitt	257
Clinton, General	257
Colburn, Zerah	213, 301
Colvin, Henry	305
Cooke, Watts	299
Cooper, Peter	52
Costell, Stacey	64, 113
Danforth, Chas.	248
Davis, Phineas	64, 112
Davis and Gartner	113
Detmold, C. E.	51
Dotterer, David H.	298
Dotterer, Thos.	58
Dougherty, Sam'l	119
Dripps, Isaac	86
Eaton, Richard	621
Eddy, Wilson	205
Edgeworth, Richard	15
Ellet, Chas.	131
Evans, Oliver	17, 46
Fairlie, Robt. F.	193
Fulton, Robt.	157, 158
Gillingham, Geo.	69
Grant, D. B.	247
Griggs, Geo. S.	200
Hackworth, Timothy	37
Hamilton, Alexander	231
Harrison, Jos.	144, 147
Hazelboon, W. A.	216
Hedley, Wm.	24
Hill, John A.	93
Hone, Philip	155
Howe, Wm.	119
Ingham, Sam'l D.	144
James, J. H.	236
James, Wm. T.	65, 112, 118, 240
Jervis, John B.	150, 152
Johnson, Geo. W.	63
Joy, David	35
Kinsey, J. I.	255
Kirk, Lewis	284
Kirtley, Matthew	38
Knight, Jonathan	68, 112
Laird, John P.	212
Lathrobe, Benj. R.	71
Lauder, Jas. N.	213
Long, Col. Stephen	112, 116
Mallet, Anatole	194
Mason, David	114
Mason, William	181, 183

Personal—	
Mason, Wm., As a Locomotive Build- er	184
Beautifuls Locomotive	183
Builds Locomotives for Fun	184
Introduces Walschaert Motion	189
Portrait of	181
Work of	187
Master Machinist, First	53
Matthew, David, Pioneer Locomotive Engineer	56, 156, 159
McCallum, D. C.	276
McConnell	36
McHenry, Jas.	252
McIntosh, John F., Locomotive De- signer	41
McQueen, Walter, Building Locomo- tives	296
Mallet's Compound	195
Introduced by J. E. Muhlfeld	328
Mehaffey, A.	108
Miller, E. L., Designs Locomotive	65, 120
Millholland, James, Pioneer Engineer	63
Work on Locomotive	63, 286, 287, 294
Minot, Chas.	275
Moorson, Capt.	117
Morse, F. W.	623
Muhlfeld, J. E., Introduces Mallet Locomotive	82, 328
Murdoch, Wm., Work of	14
Newcomen, Thos.	6
Nichols, G. A.	234
Norris, Edward S.	96
Norris, Wm.	112, 117
Papin, Dennis	11
Perkins, Thatcher	80
Petsch, Julius D.	58
Richards, Geo.	204
Roberts, Solomon W.	102
Robb, F. W.	623
Rogers, Thos.	232, 242
Sanford, J. W.	96
Savery, Thos.	10
Sellers, Chas.	138
Sellers, Coleman	137
Sellers, Dr. Coleman	138
Sellers, Geo. Escol.	133
Simpson, Thos.	283
Smeaton, John	8
Stephenson, Geo.	26
Stephenson, Robt.	29
Stevens, Col. John	63, 100
Stevens, Robt. L.	84, 86, 249
Stirling, Jas.	41
Stroudley, Wm.	39
Swinburne, Wm.	243
Sykes, L. A.	127
Taylor, J. K.	219
Thompson, C. A.	252
Thompson, John	211
Thomson, John Edgar	100
Trevithick, Richard	20
Trevithick, F. H.	619
Tyson, Henry	79
Underwood, F. D.	278
Vauclain, Andrew C.	282
Vauclain, S. M.	655
Wallis, Herbert	610
Webb, F. W.	42
Westinghouse, Geo.	528
Whistler, Major	174
Whitney, Eli	128
Williams, Wm.	119, 240
Wilson, Major John	100
Winans, Ross	66, 113
Worsdell, T. W.	43

## PORTRAITS.

Allen, Horatio	53
Baldwin, Matthias W.	122
Bell, J. Snowden	429
Brooks, H. G.	276
Boyden, Seth	251
Colvin, Henry	305
Cooke, John	249

## Portraits—

Cooke, Watts	300
Cooper, Peter	61
Dripps, Isaac	88
Ebbert, John	366
Eddy, Wilson	205
Ely, Theo. N.	355
Evans, Oliver	17
Fish, Stuyvesant	375
Forney, M. N.	551
Goss, Prof.	425
Griggs, Geo. S.	199
Harrison, Jos.	142
Hodgins, Geo. S.	609
Hudson, Wm. S.	237
Hughitt, Marvin	364
Kennedy, James	476
Mason, Wm.	181
Millholland, James	287
Mitchell, Alex.	314
Muhlfield, J. E.	329
Murdoch, Wm.	15
Quayle, Robt.	422
Reynolds, O. H.	386
Rogers, Thos.	235
Sanno, Walter de	343
Sellers, Chas.	139
Sellers, Coleman, Jr.	140
Sellers, Coleman, Sr.	137
Sellers, Geo. Escol.	138
Stephenson, Geo.	26
Stevens, Col. John	101
Stevens, Robt. L.	84
Stone, Henry B.	414
Swinburne, Wm.	243
Thompson, C. A.	253
Trevithick, Richard	20
Truesdale, W. H.	310
Underwood, F. D.	273
Vauclain, Andrew	283
Vauclain, S. M.	656
Vaughan, H. H.	430
Wallis, Herbert	610
Watt, James	9
Westinghouse, Geo.	527
Winans, Ross	72

## MISCELLANEOUS.

Railroad, Agitation in Favor of, Building	49
Albany and Schenectady	155
Auburn and Syracuse	160
Baltimore and Ohio, 46, 48, 51, 61, 65, 112, 154	
Baltimore and Susquehanna	150
Beaver Meadow	143, 313
Boston and Lowell	175
Boston and Providence	175
Boston and Worcester	173
Burlington Brake Tests at	537
Camden and Amboy	84, 100, 150
Central of Georgia	134, 136
Columbia, as a Training School	106
Curiosities of, Construction	261
Delaware and Hudson	48, 155
Erie	256
First Chartered	48
First Chartered in America	85
First New England Opened	171
First Proposed	15
Hazleton	324
Industrial Polley	223
Ithaca and Owego	295
Leggett's Gap	296
Lehigh Valley	143, 311
Mad River and Lake Erie	236
Madison and Indianapolis	130
Mahanoy	315
Mania	222
Mauch Chunk	48
Mine Hill and Schuylkill Haven	151
Mohawk and Hudson	151
Mount Carbon	151
Newcastle and Frenchtown	115, 151

## Railroad—

New Jersey Charters	48
New Jersey Transportation	127
New York Central	150, 160
Northern Central	150
Operating, as a Private Highway	102, 171
Pay Roll of Columbia	107
Pennsylvania	135, 150
Pennsylvania, Chartered	341
Pennsylvania, First Links of	84
Pennsylvania, Winning the West	339
Penn Haven	315
Philadelphia and Columbia, 100, 118, 340, 347	
Philadelphia and Germantown	122, 146
Philadelphia and Reading	129, 280
Phillipsburg and Juniata	48
Portage	343
Purpose of Camden and Amboy	99
Quincy Quarries	48, 164
Saratoga and Schenectady	159
South Carolina	48, 50, 149, 151
Syracuse and Utica	160
Utica and Schenectady	160
Virginia Central	131
White Haven	315
Railroads, Americans Proceed to Build	46
As Public Highways	102, 171
Numerous Short, Chartered	150
State Control, of New England	170
Westward Ho!	357
Where American, were Born	165
Rails, Inferior Iron	327
Introduction of Steel	327
Political Effect of Cheap	328
Railway, Birmingham and Gloucester	117
Canadian Pacific	625
Grand Trunk	610
Great Eastern	43
Leicester and Swanington	37
Liverpool and Manchester, 25, 28, 34, 123	
London and Brighton	35
London and North Western	42
Midland	38
National Transportation	629
New Castle and Carlisle	37
Prince Edward Island	601
Stockton and Darlington	28
St. Petersburg and Moscow	149
Railways, Genesis of American	44
Rainhill, Competitions	29
Reliability, First Consideration	33
Savery, Thos., Inventions of	6
School, Columbia Railroad as Training	106
Scranton, City Site Chosen	296
Shop, Early, Practise	202
Organizing a	124
Shops, First Railroad Machine	68
State Railroad Repair	107
Westinghouse Air Brake	541
Smeaton's, John, Work on Newcomen's Steam Engine	8
Smoke Prevention, Devices for	135
Spark Arresters, Diverse Classes of	410
Labor of Master Mechanics Association on	413
Matthew, on	411
Smoke Box	423, 424, 427, 428
Stone's, Henry B., Report on	413
Quayles Report on	420
Sparks Arresters Illustrated, Baldwin's	408
Dripps	410, 423, 424
Drowning	427
Espy's	409
Master Mechanics Standard Front End	428
Matthew's	412
McIlvain's	417
Miscellaneous	415, 418, 419, 421
Speed, Desire for High	631
Stack, Invention of Diamond	204
Steam Engine, Baldwin's First	114
Branca's Crude	3

## Steam Engine—

Evans, Oliver, Invents High Pressure	17
First Radical Improvement on	7
Greatest Invention	1
Growth of	1
Improving Newcomen's	2
In Egypt	2
Marquis of Worcester's Work on	5
Necessity Demanding the	4
Papin's Work on	6
Practical High Pressure Proposed	11
Romans' Knowledge of	2
Weak Feature of Newcomen's	8
Steel, Axles Introduced	135
Fire-boxes Tried	135
Tires Tried	135
Stephenson, Geo., First Locomotive	
Built by	27
Portrait of	26
Stevens, Col. John, Railroad Builder	63
Stevens, Robt. L., Invents Iron Rail	86
Portrait of	84
Work of	86
Stirling, Jas., Applies for Wheel Truck	41
Stoker, Chain Grate Automatic	406
Stretton, Clement E.	22
Stroudley, Wm., Locomotive Designer	39
Tests, Burlington Brake	537
Galton-Westinghouse	533
Master Car Builders Brake	536
Rainhill	29
Thomson, John Edgar, Appointed Chief Engineer	342
Tires, Brass	127
Cast Iron	293
Tools, Primitive Shop	209
Traction Increaser, Baldwin's	127
Rogers'	237
Train Brake, First Form of	513
Growth of	512
Patented	512
Train Rules, First Used	108
Trains, Heavy	328
Trenton Locomotive Works, Build	
Monster Locomotive	94
Trevithick, Richard, Builds First Locomotive	20
Truck, Bogie Adopted	40
Jervis Engine	153
Turbine, Branca's Steam	3
Valve, Peculiar Throttle	618

## VALVE MOTION.

Valve Motion, Baldwin's	133
First Automatic	8
Of Stevens' Crampton Locomotive	96
Mason Introduces Walschaert	139
Valve Motion, Illustrated, Allan's	
Straight	467
Baldwin's First Link	466
Baldwin's Variable Cut Off	451

## Valve Motion—

Bury's Drop Hook	426
Carmichael's	426
Clark's, David	463
Common V Hook	449
Connected Double Hook	459
Crampton's Expansion	441
Cuyahoga's Cut Off	453
Direct	473
Eccentric First Used	433
Early Pennsylvania	464
Eastwick's Reversing	443
Forrester's	437
Gosenbach's Cut Off	453
Gray's Expansion	441
Hawthorne's Radial	438
Hubbel's Allfree	473
Joy's	459
Lustral Vase	431
Mason's Walschaert	469
Melling's Radial	438
Newcomen's	432
Norris'	462
Original Link	445
Pauwel's	439
Ray's Cut Off	461
Roberts' Piston	442
Rogers' Hook	455
Rogers' Link Motion and Cut Off	458
Rogers' Suspended Link	456
Rogers' Underhung Link	457
Showing Method of Using Eccentric	434
Stephenson's Hook	440
Stevens, A. J.	468
Stevens, John	463
Uhry and Lutgens	454
Walschaert	475, 476, 477, 479, 480
Wilson, Wm.	465
Winans' Ross	446
Winans' Drop Hook	447, 448
Young's	469
Valves, Consolidation Safety	576
Richardson's Safety	574
Safety, Invention of	578
Wages of Railroad Men	197
Walschaert Motion, Mason Introduces	139
Watt, Jas., Discoveries of	9
Improves Newcomen's Engine	9
West Point Foundry, Builds Locomotives	55
Westinghouse Air Brake Company, Officials of Illustrated	543
Westinghouse Works at Wilmerding	541
Wheels, Elastic	203
Large Driving	96
Whistle, First Steam	572
Winans, Ross, Engineering Genius	66
Work on Locomotive	72
Worcester, Marquis of, Work on Steam Engine	5
Worsdell, T. W., Designer of Compounds	43



# BALDWIN LOCOMOTIVE WORKS

BURNHAM, WILLIAMS & CO., PHILADELPHIA, PA., U. S. A.

Cable Address, "BALDWIN, PHILADELPHIA"



## LOCOMOTIVES of Every Description

Electric Locomotives, Electric Motor and Trailer Trucks  
for Railway and Suburban Service

---

## STANDARD STEEL WORKS

HARRISON BUILDING, PHILADELPHIA, PA.

STEEL TIRED WHEELS



SOLID FORGED  
ROLLED STEEL WHEELS

RAILWAY SPRINGS  
CASTINGS

LOCOMOTIVE TIRES  
FORGINGS

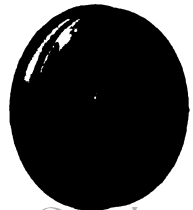

# LIGHT LOCOMOTIVES

For All Classes of Service  
 ANY TYPE ANY GAUGE

V  
U  
L  
C  
A  
N



V  
U  
L  
C  
A  
N

## VULCAN IRON WORKS

WILKES - BARRE, PA.

Established 1848

U. S. A.

## Detroit Seamless Steel Tubes Company

Makers of

"Detroit" Locomotive Flues || **Cold Drawn**  
 "Detroit" Safe Ends || **Seamless Steel**  
 "Detroit" Arch Tubes

General Office  
 and Works  
 DETROIT, MICH.

New York Office  
 12-16 JOHN STREET  
 THORNTON N. MOTLEY & CO.

Agents

Digitized by Google

*William Sellers & Co. Incorp.*

PHILADELPHIA, PA.

## Modern Machine Tools

**For Railroad and General Work**

Axle Lathes      Wheel Lathes      Frame Slotters  
**TRAVELING CRANES**                      **JIB CRANES**

Rod Borers                      Cylinder Borers  
**POWER TRANSMISSION MACHINERY**

Car Wheel and Driving Box Borers  
**TURNTABLES FOR LOCOMOTIVES AND  
SHOP CARS**

Tool Grinders

Drill Grinders

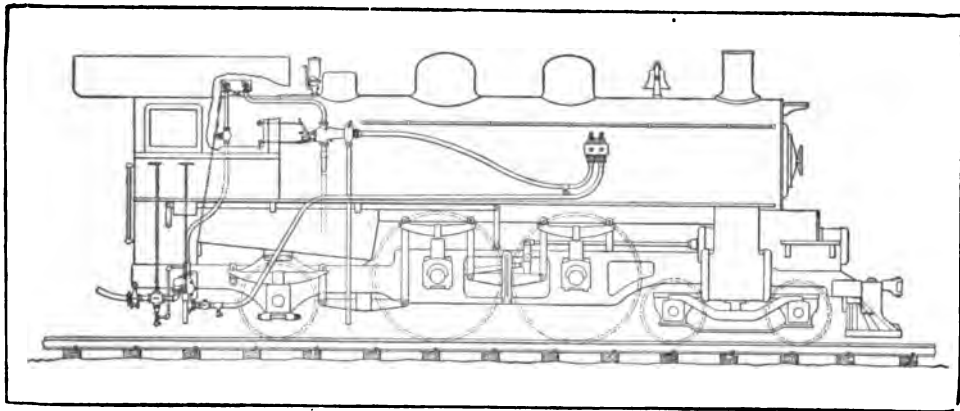

## 1860 **SELLERS INJECTORS** 1907

Lead in Efficiency, New Features and Low Cost of Maintenance

**THE SELF-ACTING INJECTOR**

Lifting and Non-Lifting

**MAIN CHECK AND STOP VALVES**

Single and Duplex

**FEED WATER STRAINERS, BOILER WASHERS, Etc.**

DESCRIPTIVE MATTER CHEERFULLY FURNISHED

**The  
McConway & Torley Co.  
Pittsburg, Pa.  
U. S. A.**

---

---

The original manufacturers of M. C. B. type  
of coupler, exclusive makers of:

**the JANNEY**

**the JANNEY "X"**

**the KELSO**

**the PITT**

**and**

**the BUHOUP 3-STEM Couplers**

Special designs made on request adapted to  
any style of locomotive and to meet any special  
conditions of service.

---

---

**MALLEABLE IRON and OPEN HEARTH  
STEEL CASTINGS for Railroad Work**

# GOLD CAR HEATING & LIGHTING CO.

Manufacturers of  
ELECTRIC, STEAM AND  
HOT WATER APPARATUS  
FOR RAILWAY CARS  
EDISON STORAGE BATTERY  
FOR RAILWAY CAR LIGHTING

Largest Manufacturers in the World of Car Heating Apparatus  
Catalogues and Circulars cheerfully furnished

Main Office, Whitehall Building  
17 BATTERY PLACE : : : NEW YORK

## NATHAN MANUFACTURING COMPANY

92 & 94 LIBERTY ST., NEW YORK, U. S. A.

INJECTORS AND ATTACHMENTS

**LOCOMOTIVE LUBRICATORS and OILERS**  
and **BOILER FITTINGS**

**INJECTORS**

Monitor, "F.W.," the Simplex, New Nathan  
Lifting and Non-Lifting Types

**Sight-Feed Lubricators**

Nathan, Bull's Eye, "1899"  
The "Disc" Glass used does not break

**BOILER  
FITTINGS**

Coale Muffler and Safety Valve

Klinger's Reflex Water Gauge

Fire Extinguishers, Boiler Washers, Steam Sanding Apparatus, Globe  
Valves, Steam Gauge Cocks, Blow-off-Cocks, etc., etc.

**NATHAN - NEW YORK**

# PRESSED STEEL CAR CO.

DESIGNERS AND BUILDERS OF

## Steel Passenger Equipment STEEL AND COMPOSITE FREIGHT CARS

The adoption of pressed steel cars assures larger net earnings per train-mile, longer service, less repairing, increased capacity at terminals and sidings.

Trucks for Cars and Engine Tenders

### PRESSED STEEL SPECIALTIES

OFFICES:

PITTSBURG    NEW YORK    CHICAGO    ATLANTA    LONDON    MEXICO  
SYDNEY, N. S. W.



## STAR BRASS MANUFACTURING CO.



MANUFACTURERS OF

**EXTRA HEAVY MUFFLED  
AND OPEN LOCOMOTIVE POP VALVES  
"NON-COROSIVE" STEAM AND DUPLEX AIR GAGES  
CHIME WHISTLES, AUTOMATIC WATER GAGES  
SEIBERT LUBRICATORS, RELIEF VALVES  
DEAD WEIGHT GAGE TESTERS**

and other Standard Locomotive Appliances

MAIN OFFICE AND WORKS:

108-114 EAST DEAHAM ST.  
BOSTON, MASS.

BRANCHES:

NEW YORK 70 Cortlandt St.	CHICAGO 56 Fifth Ave.	PITTSBURGH 525 Third Ave.
RICHMOND, VA. 29 Chamber of Commerce Bldg.	MONTREAL, CAN. 180 St. James St.	
LONDON, ENG., 28 New Bridge St.		





The Detroit No. 21  
Locomotive Lubricator

## THE UP-TO-DATE LUBRICATOR FOR MODERN LOCOMOTIVES

The DETROIT No. 21 Locomotive Lubricator is admirably adapted for use on high pressure locomotives. It is simple in construction, harmonious in design, reliable in operation and economical in the use of oil as well as in regard to maintenance.

Descriptive pamphlet showing sectional views and containing a large amount of lubricator information, helpful hints, etc., will be sent on application.

**DETROIT LUBRICATOR COMPANY**  
DETROIT, MICHIGAN

## LEARN VALVE SETTING

ON FINEST VALVE MOTION MODEL EVER MADE

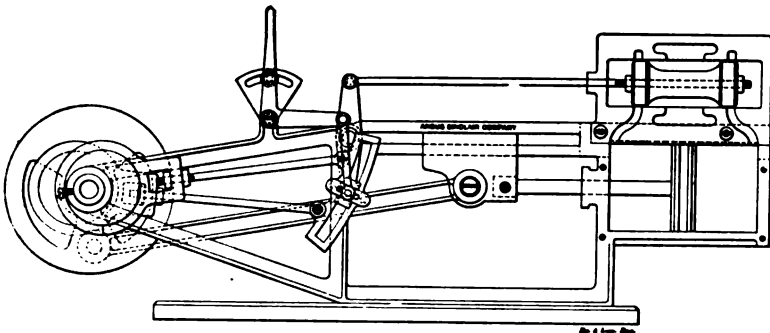

Valve Setting can be learned as readily  
on this model as on a locomotive. Every  
part capable of adjustment. Price \$15.00

**ANGUS SINCLAIR CO.,**

136 LIBERTY STREET

Digitized by Google  
NEW YORK

# The SAFETY CAR HEATING & LIGHTING CO.

United States Express Building, 2 Rector Street, New York City  
 CHICAGO PHILADELPHIA ST. LOUIS SAN FRANCISCO

## SAFETY HEATING SYSTEMS

Practical service for the past 19 years has demonstrated the reliability, efficiency and adaptability of the Safety Systems of direct steam and hot water heating. Straightport Couplers and Automatic Steam Traps.

160 RAILROADS USING THESE DEVICES ON 19,000 CARS

GRAND PRIZE ST. LOUIS EXPOSITION 1904

NEW INVERTED MANTLE



### LAMPS FOR PINTSCH GAS

Illumination increased over three times without additional gas consumption.  
 A revolution in the lighting of railroad cars.

### PINTSCH SYSTEM CAR and BUOY LIGHTING

Has been applied to 31,000 cars by 200 railroads in the United States, Canada and Mexico. In the World 151,000 cars, 7,300 locomotives, 2,200 buoys and beacons, 125 lightships and vessels are using this system, and 375 gas works have been established. Gold medals for excellence at the World's Expositions at Moscow, Vienna, St. Petersburg, London, Berlin, Paris, Chicago. Atlanta and Buffalo. Grand Prize St. Louis Exposition 1904.



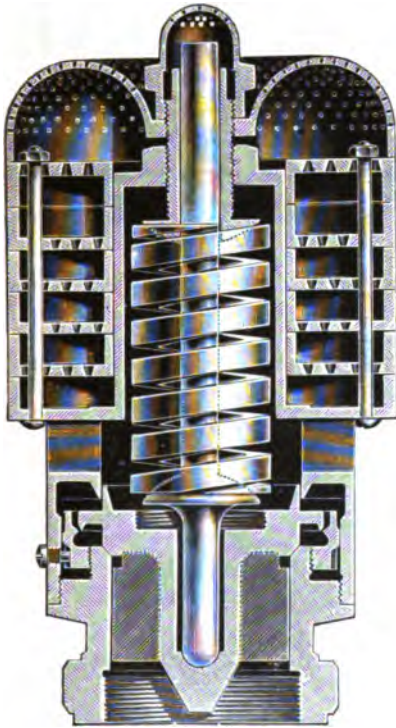

## The CONSOLIDATED Locomotive Muffler Safety Valve

Always relieves the boiler at the right pressure and closes without waste of steam.

Especially adapted for very high steam pressures.

All valves thoroughly tested under actual working conditions before leaving the factory.

For your own protection specify the Consolidated and see that you get it.

## THE CONSOLIDATED SAFETY VALVE CO.

85-87-89 Liberty Street  
NEW YORK

22-24-26 So. Canal Street  
CHICAGO

# Railway and Locomotive Engineering

A PRACTICAL JOURNAL OF  
RAILWAY MOTIVE POWER AND ROLLING STOCK

*136 Liberty Street - - New York*

An Illustrated Monthly, devoted to the Mechanical Departments of Railroads, giving 600 reading pages a year.

Best Illustrated and Most Interesting Railroad Paper published.

Contains Good Education | Matter for every class of railroad men.

Over 22,000 readers. No shopman, engineer or fireman can keep thoroughly posted without it.

Air-Brake Department alone is worth the yearly subscription every month.

**\$2 PER YEAR**

Digitized by Google

# DETAILS OF LOCOMOTIVES

---

---

**T**HREE forms, viz.: 4-4-0, 4-4-2 and 2-8-0. Best educational medium for young engineers or firemen ever invented.

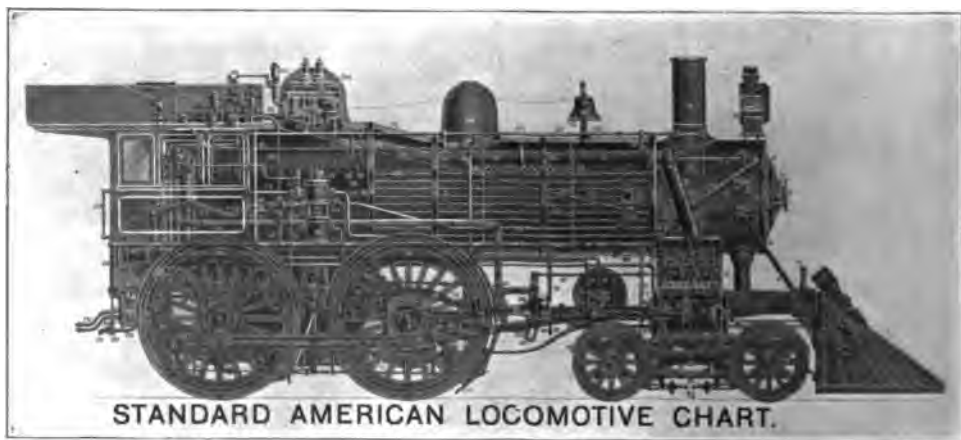

Transparent engravings like the above of the three most popular forms of locomotives are for sale in this office. They are printed on heavy plate paper, 30 x 12 inches, with every part numbered and correct mechanical name given on margin, suitable for framing. An object lesson and a reference chart in one. Mailed in protective tube free on receipt of 25 cents in coin or stamps, to any part of the United States, Canada or Mexico.

---

---

**ANGUS SINCLAIR PUBLISHING CO.**

136 Liberty St.

Digitized by Google New York

# Angus Sinclair's Works

---



---

## Development of the Locomotive Engine

The book treats of the locomotive as it has gradually grown from Hedley's "Puffing Billy" and Cooper's "Tom Thumb" to the magnificent engines that are pulling our passenger and freight trains to-day. The process of evolution is carefully described with many personal sketches of the men whose inventions and work have contributed to the perfecting of the locomotive. 300 first-class illustrations and 680 pages. - - - **\$5.00**

## Twentieth Century Locomotives

Has 670 pages dealing with the designing, constructing, repairing and operating of modern locomotives. Work shop operations, care and management of engines. Quick repairs on the road, shop tools, shop recipes, train resistance and power calculations, definitions and tables. Standard types of engines illustrated and described. Fully indexed. Most all round useful modern compendium of the locomotive. - - - **\$3.00**

## Locomotive Engine Running and Management

New edition, just revised and brought thoroughly up to date. Has a valuable Air-Brake Department. Gives the Questions and Answers of the Traveling Engineers' Form of Examination in full. Complete information about the locomotives of to-day, and most of the difficulties met with in handling them - - - **\$2.00**

## Railroad Men's Catechism

Just published. The questions used in this new book have been developed and extended from the best codes used on American railway systems. To this is added mechanical calculations, signaling operations, and descriptive section on compound locomotives, the work forming one of the most useful helps ever offered to Railroad Men. 240 pages with numerous illustrations, **\$1.00**

## Firing Locomotives

Treats in an elementary way the principles of combustion. Is easily understood by every intelligent fireman and is a convenient reference - - - **50c.**

---



---

## ANGUS SINCLAIR COMPANY

136 LIBERTY STREET

NEW YORK

# Books for Railroad Men and Mechanics

---



---

## Machine Shop Arithmetic

Shows how any shop problem is solved, and shows the "Why."

*Flexible Cloth, 50 Cents*

---

## Shop Talks

By **ICHABOD PODUNK**

Is another book which every mechanic needs. It tells in a humorous way the experience of a machinist with different foremen, and is valuable to any one in charge of men.

*Cloth, 50 Cents*

---

## Do You Want Stationary Engineer or Marine Engineer License?

If you do study **CATECHISM OF THE STEAM PLANT**, Hemenway. Contains information that will enable one to take out license to run Stationary Engine. Tells about Boilers, Heating Surface, Horse Power, Condensers, Feed Water Heaters, Air Pumps, Engines, Strength of Boilers, Testing Boiler Performances, etc., etc. This is only a partial list. Question and answer style. 128 pages; pocket size..... 50c.

---

## Compound Locomotives

Are not popular, but their mechanism and methods of operation will be understood by all intelligent engineers. Colvin on this subject is a leather bound pocket-book describing and illustrating compounds in use in this country. Tells about running, breakdowns and repairs..... \$1.00

---

## Care and Management of Locomotive Boilers

By **HENRY J. RAPS**

The best book on this subject that we know of. Also contains several chapters on oil burning locomotives and gives actual practice in the Southwest.

*Price, 50 Cents*

**LOCOMOTIVE LINK MOTION**, Fredk. A. Halsey. 1898. This explains slide valves and their use with the link motion in a clear and practical manner which can be readily understood by any mechanic. It is fully illustrated and is sure to be appreciated by the many who are anxious to become familiar with this important feature of the locomotive..... \$1.00

---



---

# ANGUS SINCLAIR CO.

136 LIBERTY STREET, NEW YORK

Digitized by Google